

**MEGA
BLOKS**

SKYLANDERS GIANTS

1



95443

Dark Castle Conquest • Conquista del castillo oscuro • Conquête du château maléfique • Eroberung der dunklen Festung
Verovering van het duistere kasteel • Conquista il castello oscuro! • Conquista do Castelo Sombrio

4x
MA17506AQW



1x
AM01113WH



3x
AM01113X



1x
M1113ARG



1x
MA03328BBG



6x
MA03328AQW



6x
MA03328BDG



4x
MA1140AQW



2x
M1312ARG



4x
AM07659BDG



2x
MA15258AQW



6x
AM01890KC



4x
AM02640ARG



44x
MA1086BDG



50x
MA1086AQW



1x
MA022501AQW



6x
MA022501F



2x
MA07590AQW



2x
MA07590F



2x
MA09393F



14x
MA09393BDG



12x
MA09393AQW



6x
MA09393BBG



2x
AM19660BDG



4x
MA1314AQW



2x
MA03019BDG



12x
MA03019ARM



3x
AS954436



2x
MA0948BDG



5x
MA0948NS



4x
M0948ARG



1x
AS954437



1x
MA15484BBG



4x
MA03773AQW



2x
MA03773BDG



11x
MA03773BBG



4x
MA18328NS



4x
MA18329NS



4x
MA09593BBG



9x
MA09593BDG



6x
M09838ARG



2x
AM17521ARG



2x
MA1389F



2x
MA1390F



2x
MA03772AQW



3x
MA03772F



2x
MA03772BBG



1x
MA09493DH



15x
MA09493BBG



2x
MA09493ARM



1x
MA09493F



4x
AM16682ARG



3x
MA09106BDG



54x
MA09013AQW



10x
MA09013ARM



97x
MA09013BDG



2x
MA09013DH



2x
MA1419F



2x
MA11101F



1x
MA1320BDG



54x
MA09023AQW



48x
MA09023BDG



1x
AM19729AQW



4x
MA10273BDG



10x
AM16384BDG



1x
AM16384ARG



45x
MA1087BDG



21x
MA1087AQW



4x
MA03873AQW



6x
MA03873BDG



3x
MA09033BDG



83x
MA09033AQW



4x
AM16638BDG

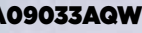

1x
AS9544313



1x
AS9544310



1x
AS9544312



1x
AS9544311



1x
AM72844ARG



2x
AM72844ARG



1x
AS9544314

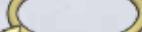

1x
AM17054AQW



2x
AM10931DH



1x
AM03089KM



4x
AM16376ANJ



4x
AM09622ARM



2x
AS954434



10x
AM09210BDG



1x
AM15964BDG



4x
AM72847BDG



1x
AM04756ARG



1x
AM04755ARG



1x
AM08728DH

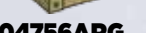



2x
MA09292AQW



2x
MA09292BDG



2x
MA09292BBG



4x
MA1480AQW



3x
MA1480BBG

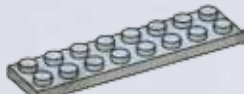

2x
MA08483AQW



2x
MA08483BBG

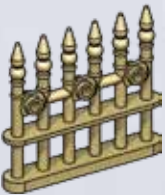

3x
AM73297ARG



1x
AM09598DH



1x
AM09599DH



2x
MA1313BDG



2x
AM06864BDG



4x
MA10233BDG



3x
AM04984BDG



1x
AM01895DH



12x
AM09623ARM



1x
AM02676KM



1x
AS954439



1x
AS954433



10x
AM72848BDG



2x
AM72845BDG



1x
AM15963BDG



1x
AM15961BDG



2x
AM15962BDG



2x
AM72841ARM



2x
AM09924NS



2x
MA1128NS

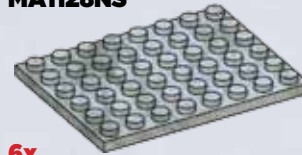

6x
AM02237AQW



3x
AM07593AQW



5x
AM03861BDG



5x
AM18845BBG



1x
AM72830ARG



1x
AM72764XG



1x
AS95400506



1x
AS95400407



1x
AS95400516



1x
AM72849BDG



1x
AX9544301



4x
AM18882BBG

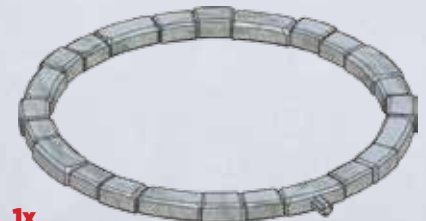

1x
AM72842AQW



1x
AS9544315

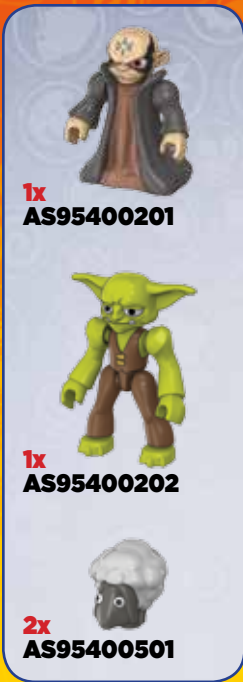

- EN Please read these instructions carefully before first use and keep them for future reference.
- FR Il est recommandé de lire attentivement ce feuillet avant la première utilisation et de le conserver pour référence future.
- ES Leer estas instrucciones cuidadosamente antes de la primera utilización y guardarlas para referencia futura.
- DE Die Gebrauchsanleitung bitte durchlesen und aufbewahren.
- NL Wij raden u aan deze handleiding zorgvuldig te lezen en te bewaren voor eventuele raadpleging op een later tijdstip.
- IT Leggere le istruzioni prima di cominciare ad usare il gioco e conservarle per referenze future.
- PT Leia as instruções antes do primeiro uso e guarde-as para futura referência.
- PL Proszę uważnie przeczytać instrukcję obsługi przed pierwszym użyciem, a następnie zachować ją na przyszłość.
- DA Vær venlig at læse disse instruktioner omhyggeligt inden ibrugtagten og opbevar dem til fremtidigt brug.
- EL Διαβάστε αυτές τις οδηγίες προσεκτικά πριν χρησιμοποιήσετε το προϊόν για πρώτη φορά και φυλάξτε τις για μελλοντική αναφορά.
- FI Lue nämä ohjeet huolellisesti ennen ensimmäistä käyttöä ja säilytä ne myöhempää tarvetta varten.
- NO Les disse instruksjonene nøye før første gangs bruk, og ta vare på dem for fremtidige oppslag.
- SV Läs noggrant igenom dessa instruktioner innan du använder produkten för första gången och spara dem för ev. framtida frågor.
- JA 初めてご使用になる前に、この説明書をよくお読みください。また、本書は将来いつでも参照できるように保管してください。
- ZH 请在初次使用前仔细阅读这些指示，并保留它们以便未来参考。
- AR يرجى قراءة هذه التعليمات بدقة قبل البدء بالاستعمال والاحتفاظ بها كمرجع للمستقبل

EN ⚠️ **WARNING :**
CHOKING HAZARD. - Small parts.
Not for children under 3 years.

FR ⚠️ **ATTENTION :**
DANGER D'ÉTOUFFEMENT. - Présence de petits éléments.
Ne convient pas aux enfants de moins de 3 ans.

ES ⚠️ **ADVERTENCIA :**
RIESGO DE ASFIXIA. - Contiene piezas pequeñas.
No recomendado para niños menores de 3 años.

DE ⚠️ **ACHTUNG :**
ERSTICKUNGSGEFAHR. - Enthält kleine Teile.
Nicht für Kinder unter 3 Jahren geeignet.

NL ⚠️ **WAARSCHUWING :**
VERSTIKKINGSGEVAAR. - Bevat kleine onderdelen.
Niet geschikt voor kinderen onder de 3 jaar.

IT ⚠️ **AVVERTENZA :**
PERICOLO DI SOFFOCAMENTO. - Contiene piccole parti.
Non indicato per bambini sotto i 3 anni.

PT ⚠️ **ATENÇÃO :**
PERIGO DE ASFIXIA. - Contém peças pequenas.
Não é concebido para crianças de menos de 3 anos.

PL ⚠️ **OSTRZEŻENIE :**
ZAGROŻENIE ZADŁAWIENIEM. - Małe elementy.
Nie nadaje się dla dzieci poniżej 3 lat.

DA ⚠️ **ADVARSEL :**
FARE FOR KVELNING. - Indeholder smådele.
Ikke til børn under 3 år.

EL ⚠️ **ΠΡΟΕΙΔΟΠΟΙΗΣΗ :**
ΚΙΝΔΥΝΟΣ ΠΝΙΓΜΟΥ. - Περιέχει μικρά αντικείμενα
Όχι για παιδιά κάτω των 3 ετών.

FI ⚠️ **VAROITUS :**
TUKEHTUMISVAARA. - Sisältää pieniä osia.
Ei alle 3-vuotiaille lapsille.

NO ⚠️ **ADVARSEL :**
KVELNINGSFARE. - Inneholder små deler.
Kun for barn over 3 år.

SV ⚠️ **VARNING :**
KVÄVNINGSRISK. - Innehåller små delar.
Inte för barn under 3 år.

JA ⚠️ **警告 :**
のどにつまる危険 小さな部品が含まれています
3歳以下の子供には与えないで下さい。

ZH ⚠️ **警告 :**
噎住危險。包含有小部件
不适合3岁以下的小孩玩。

AR ⚠️ **تحذير :**
خطر الاختناق - قطع صغيرة
غير صالحة للأطفال أقل من 3 سنوات.



WARNING !
ATTENTION !
ADVERTENCIA !
ACHTUNG !
WAARSCHUWING !
AVVERTENZA !
ATENÇÃO !
OSTRZEŻENIE !
ADVARSEL !
ΠΡΟΕΙΔΟΠΟΙΗΣΗ !
VAROITUS !
ADVARSEL !
VARNING !
警告 !
警告 !
تحذير !

0-3







1

 1x	 1x
 1x	 1x
 3x	
 1x	



1

 2x	 1x
 1x	
 1x	
 1x	

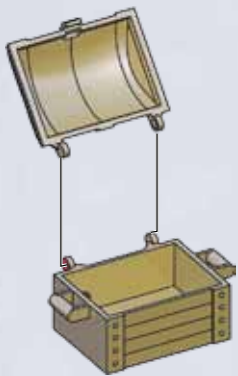

1

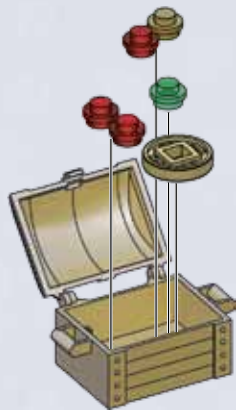

2

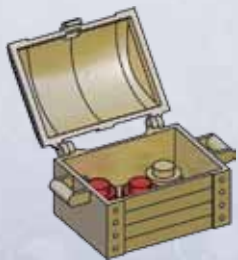

3



4

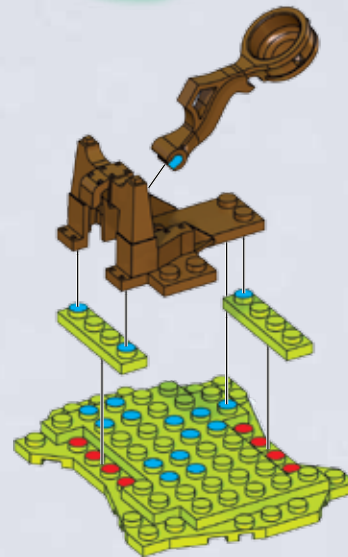

1



2



3

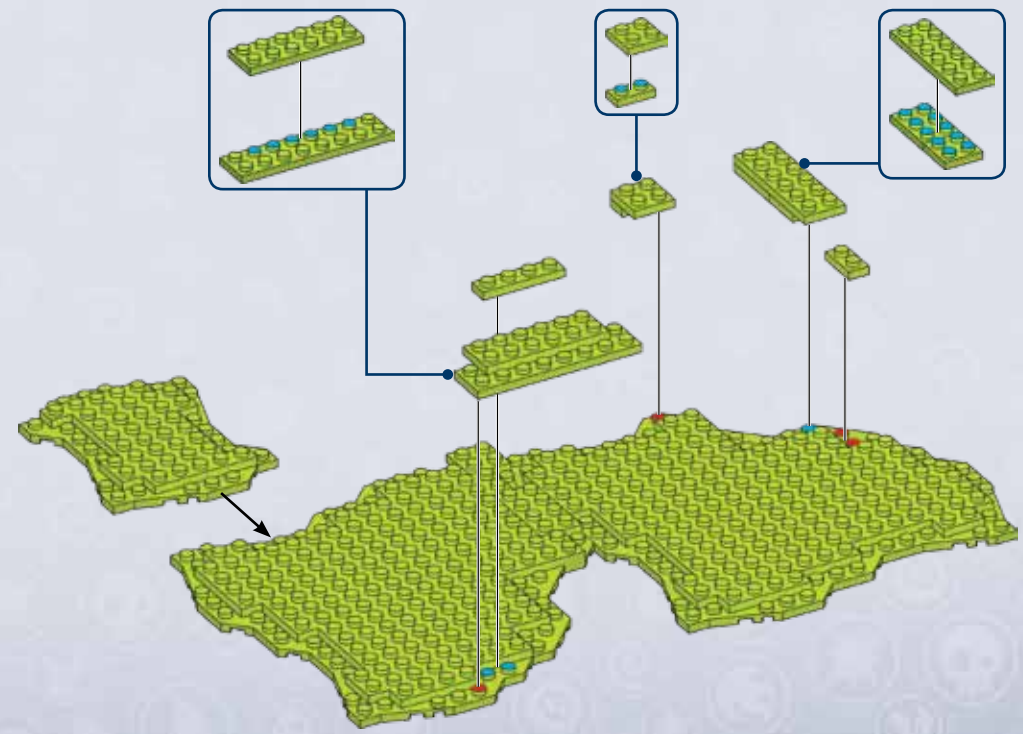
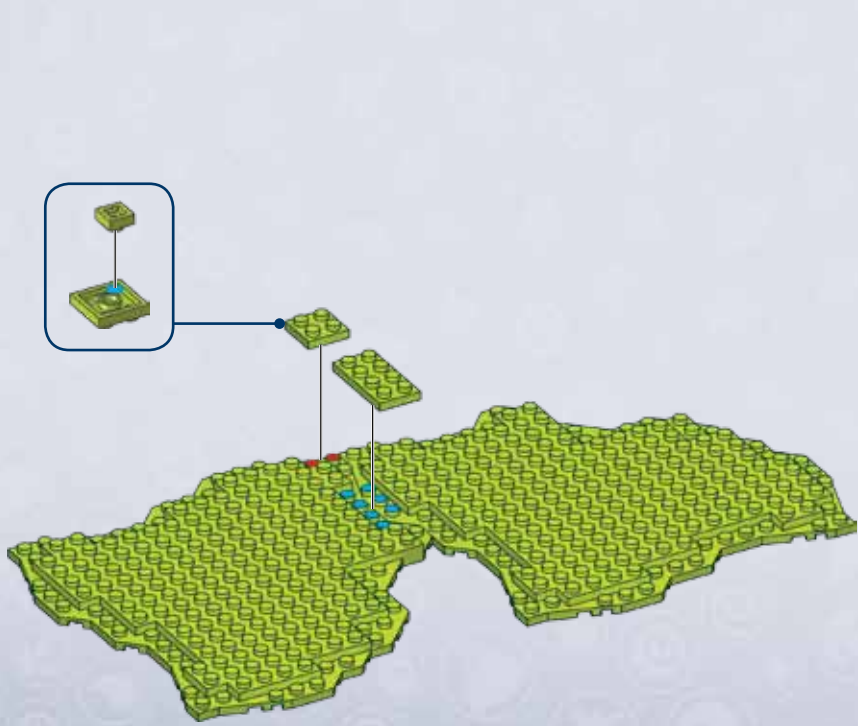
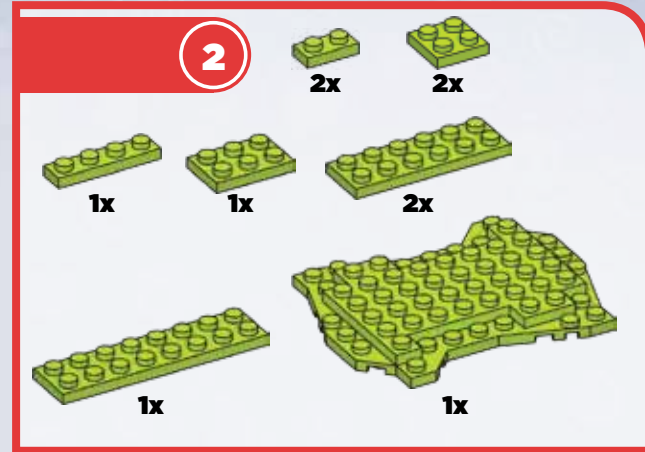
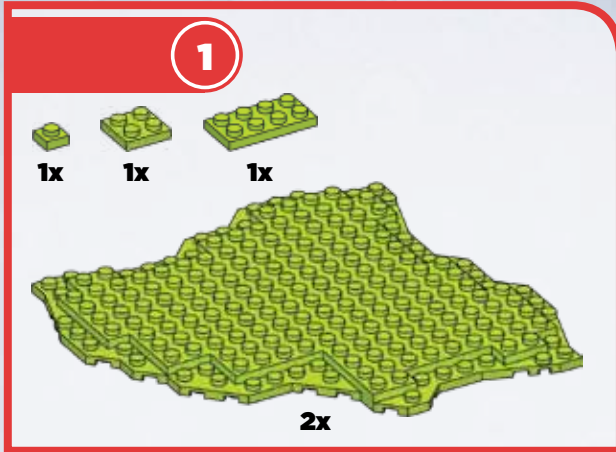

3

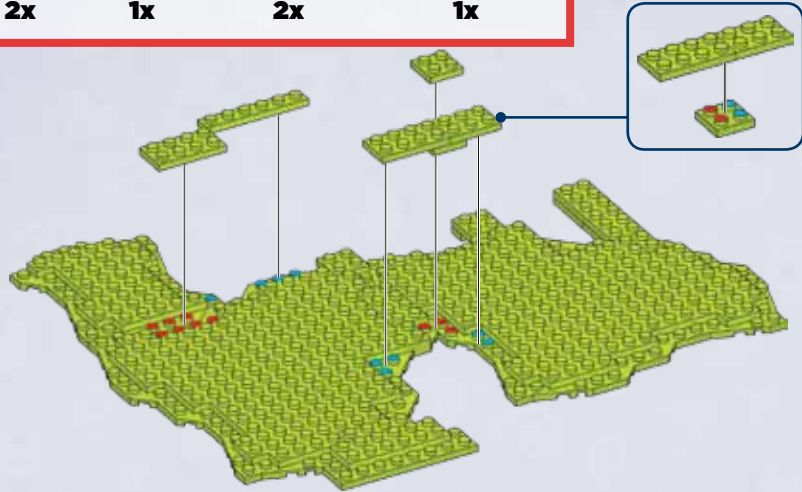

4

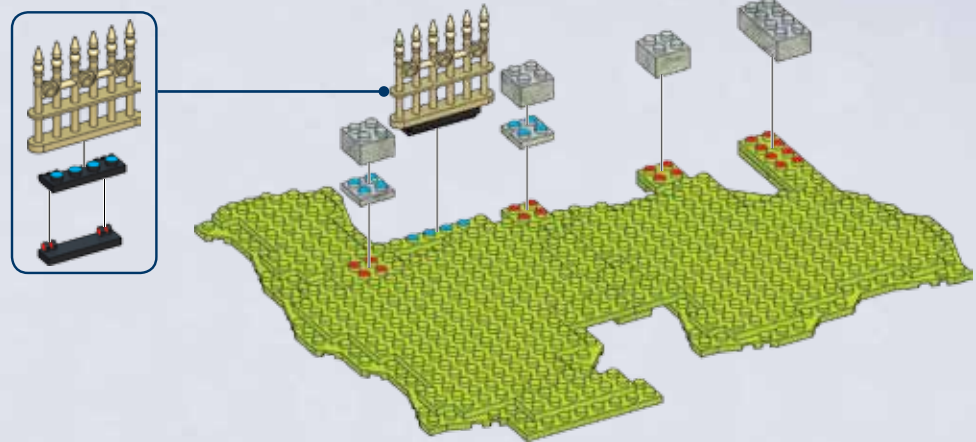
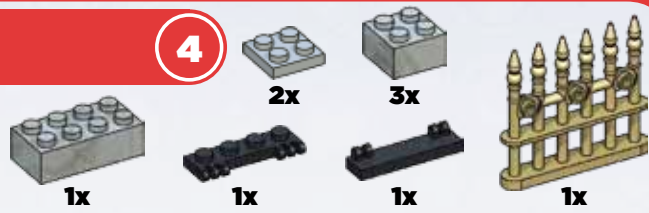

5

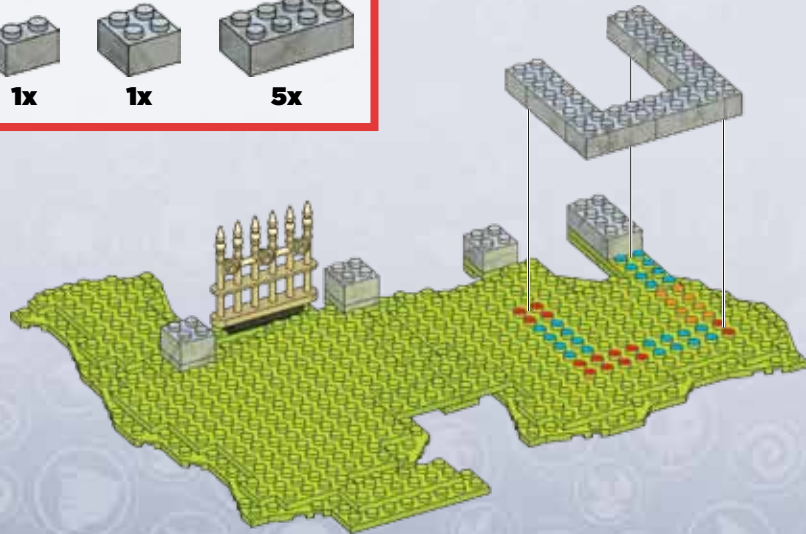

6

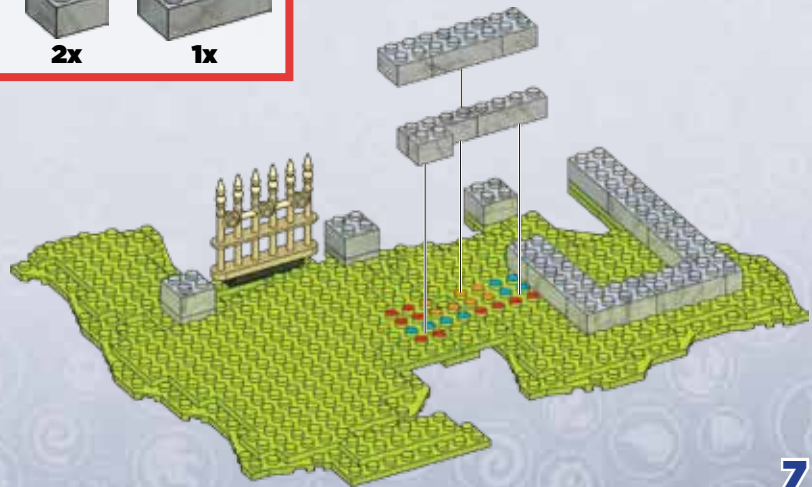
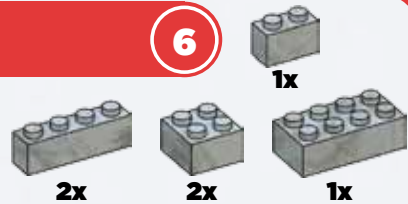

7

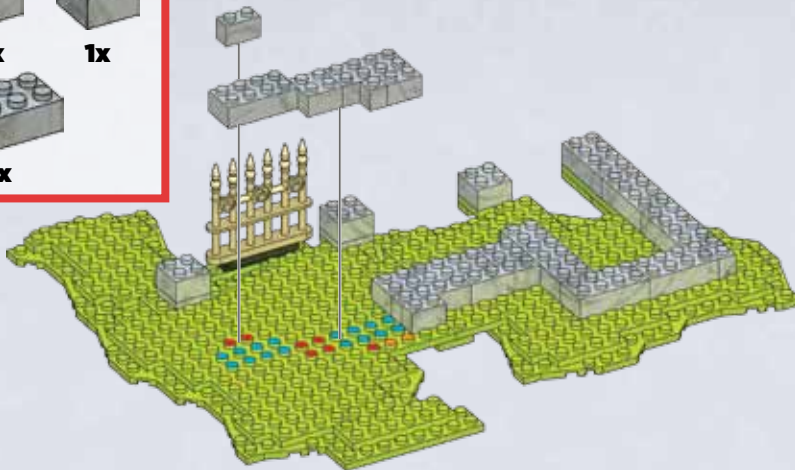
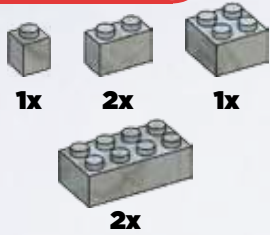

8

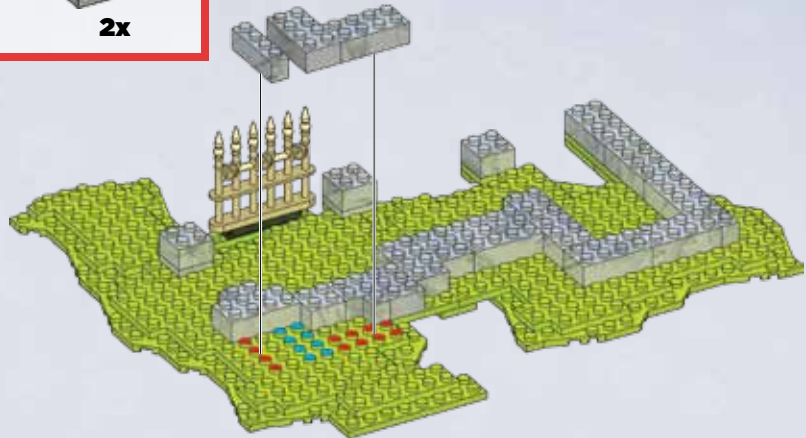
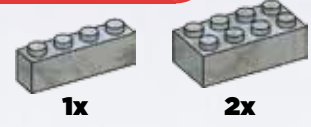

9

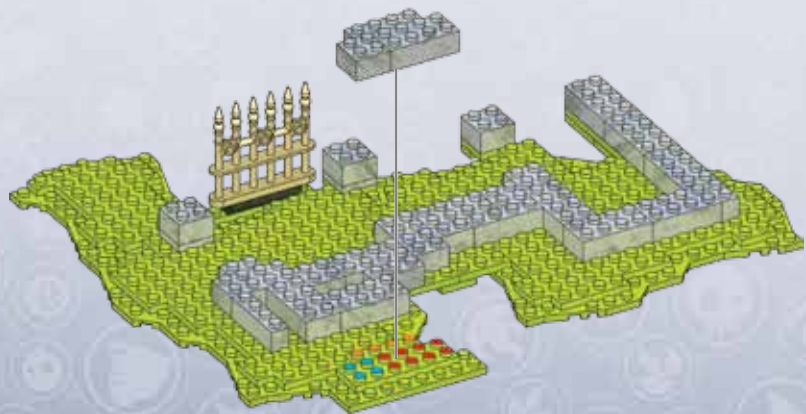

10

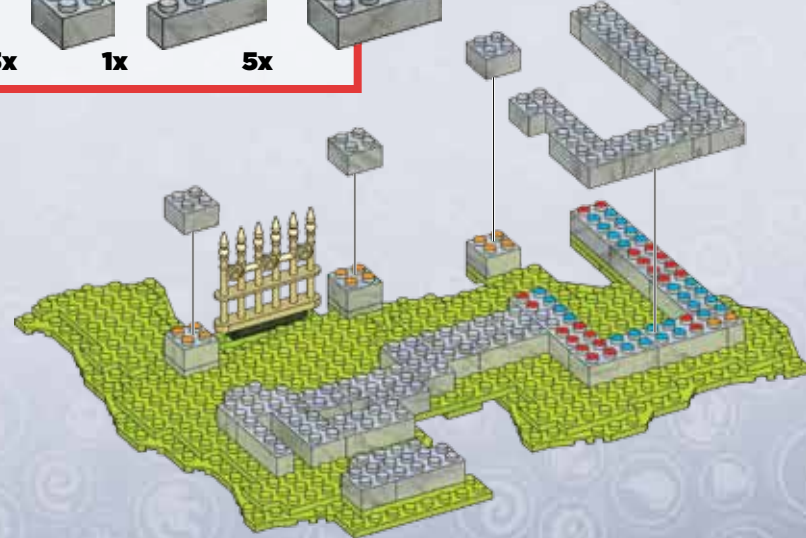
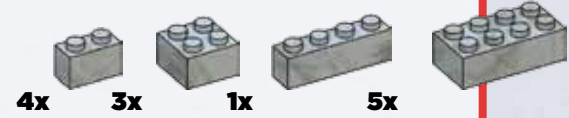

11

1x 1x 1x

1x 2x 2x

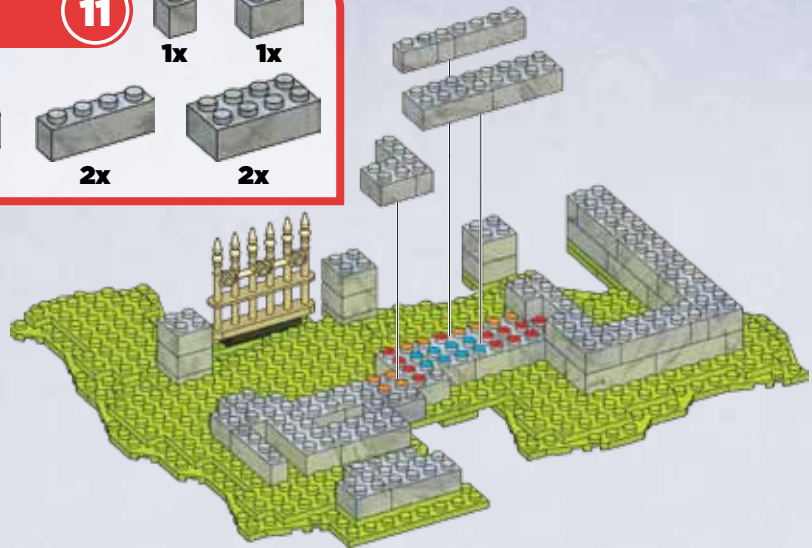

12

1x 3x

1x 2x

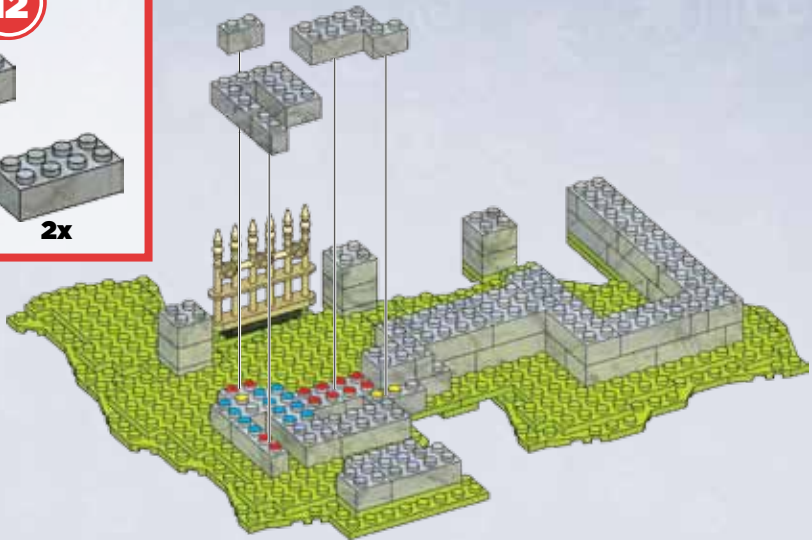

13

2x 2x

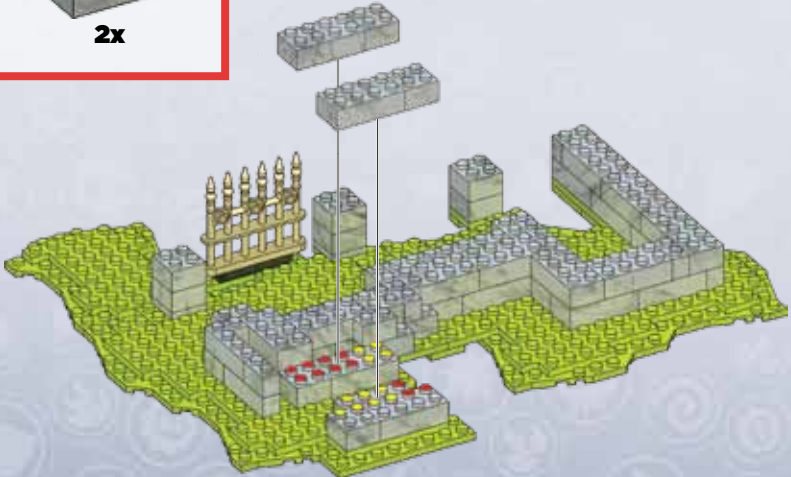

14

2x 1x

2x 1x

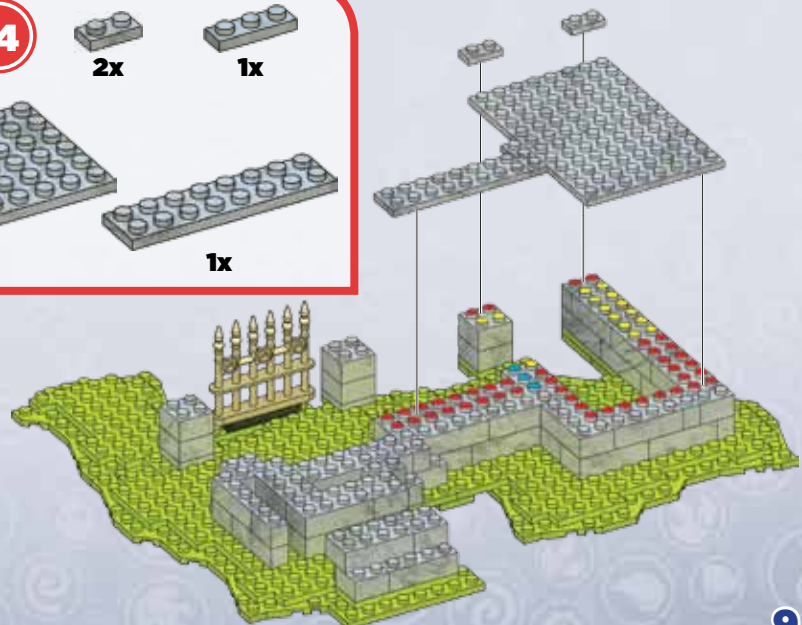

15

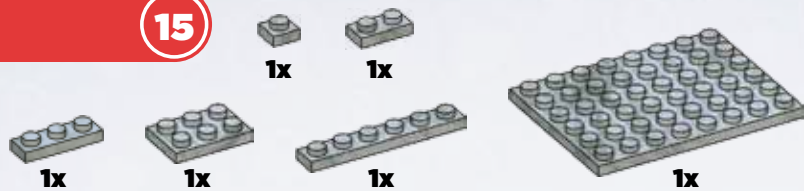

16

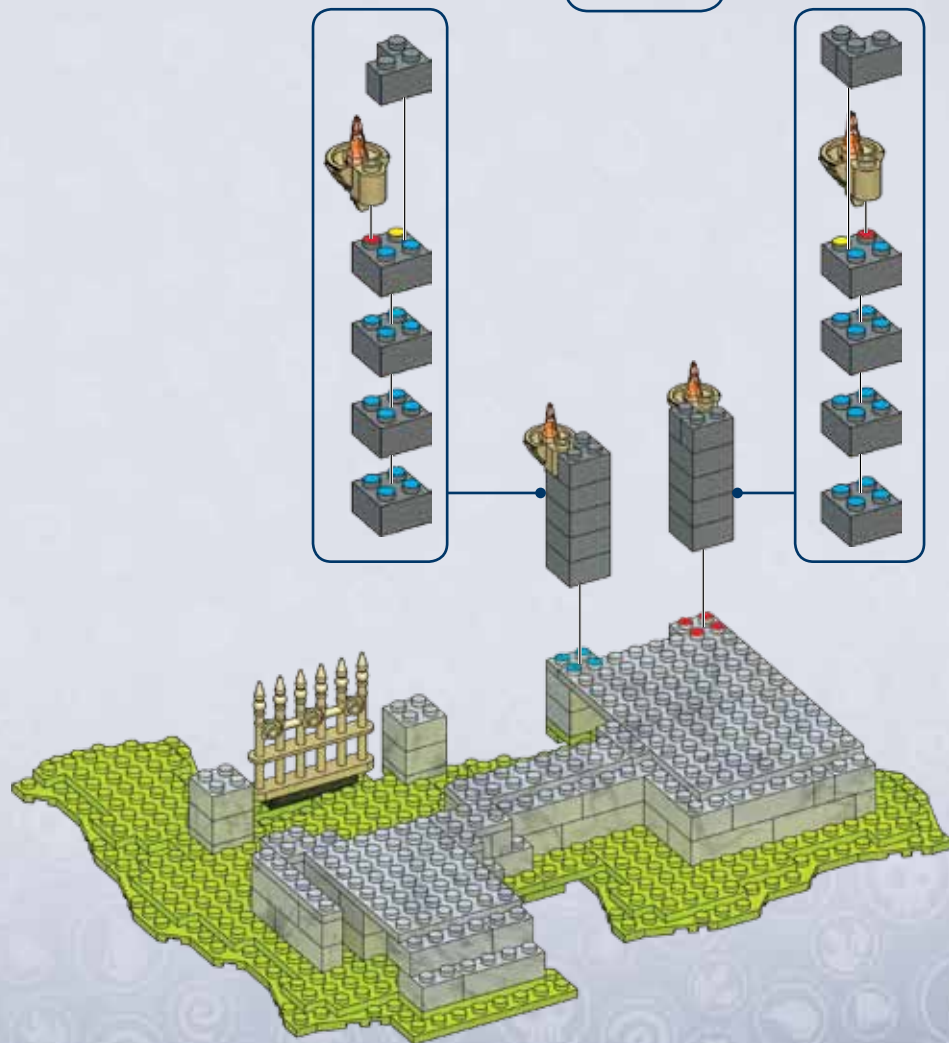
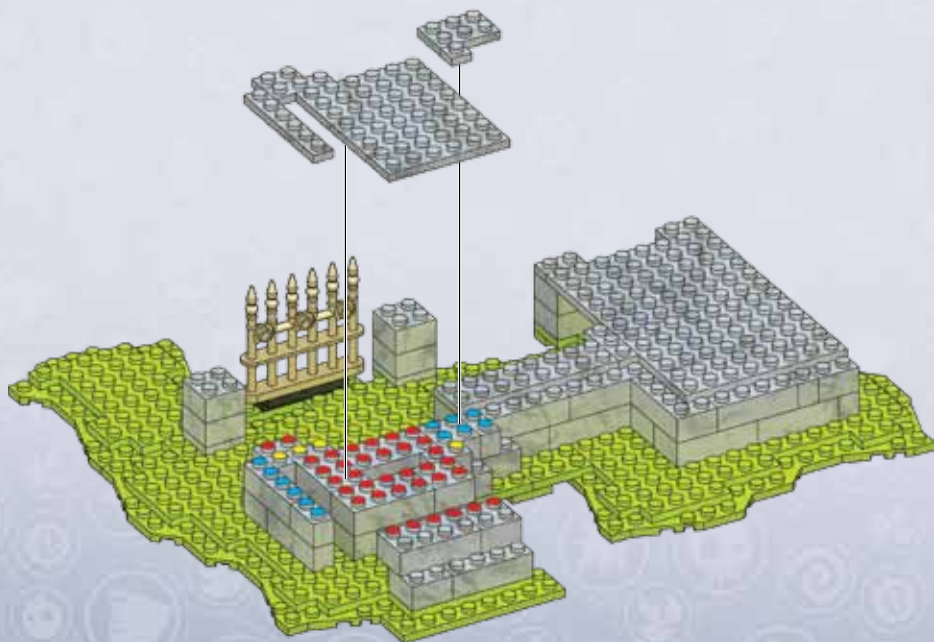

17



1x



4x



4x

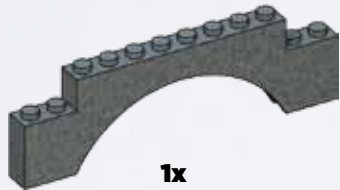

1x

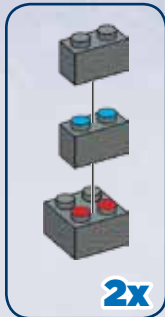

2x

1

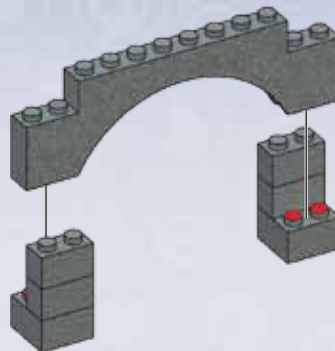

2

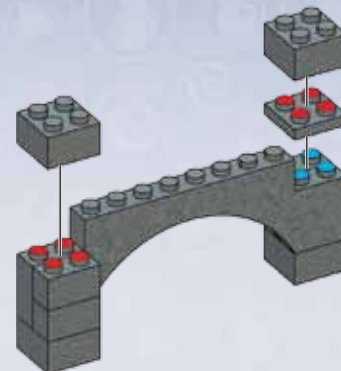

3

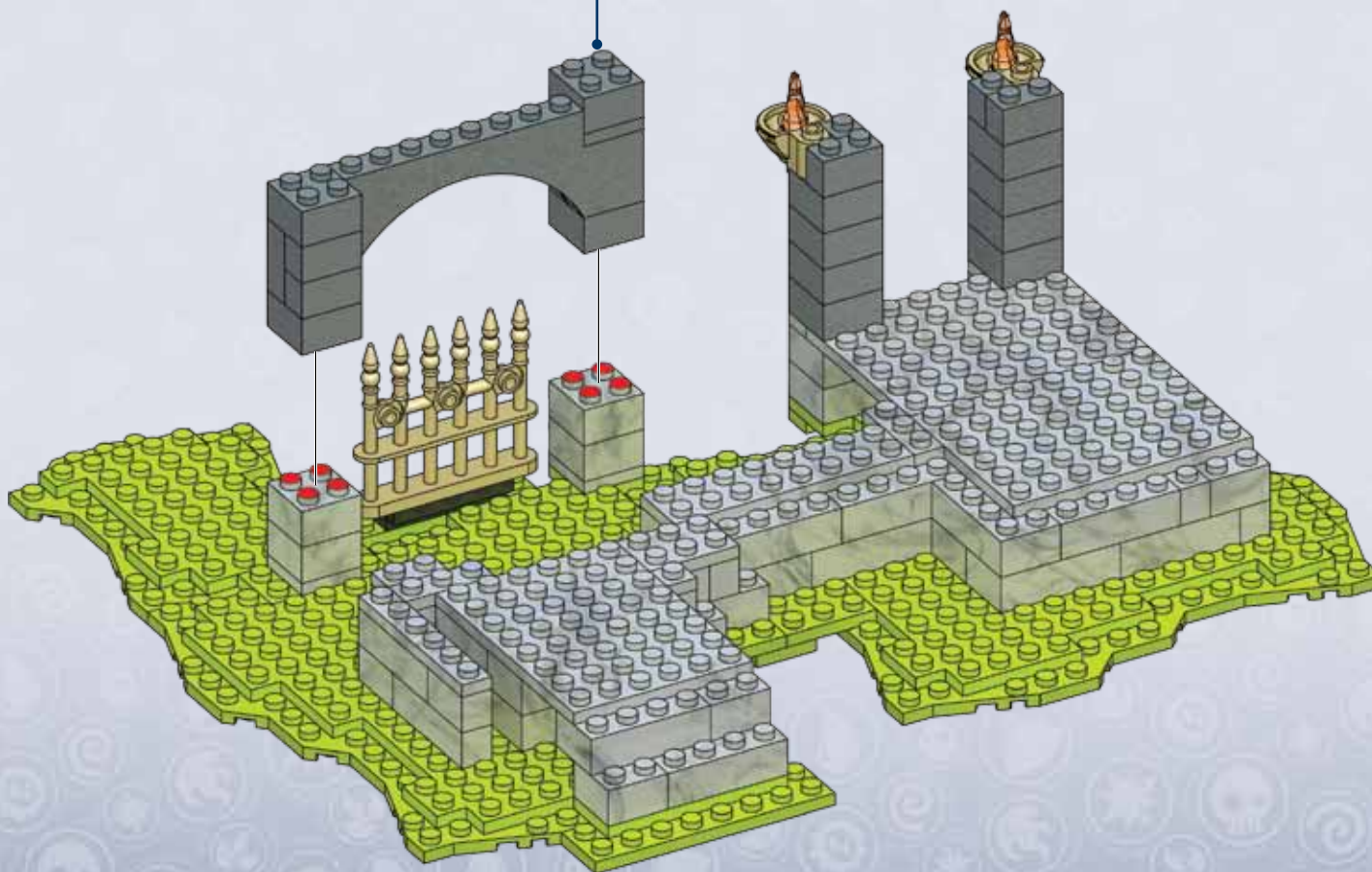

18

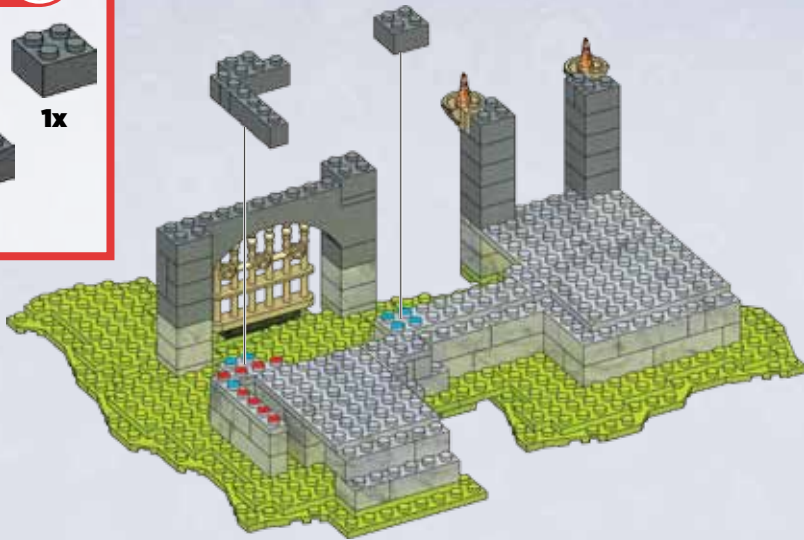
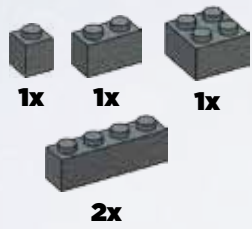

19

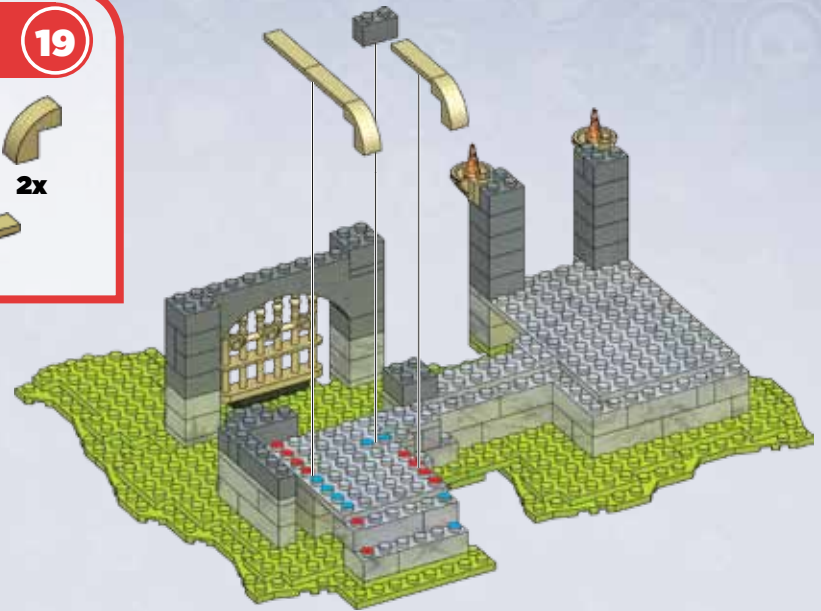
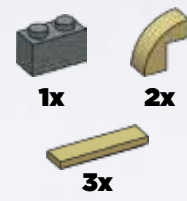

20

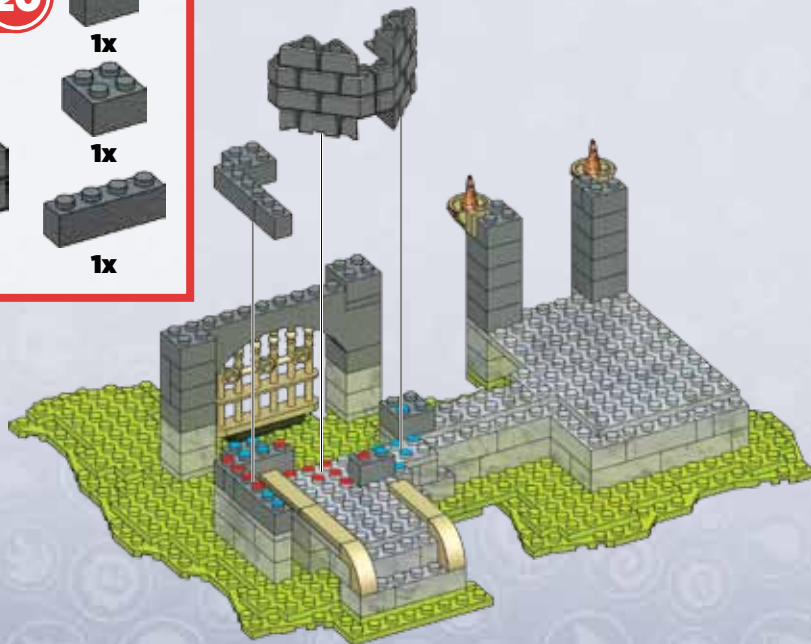
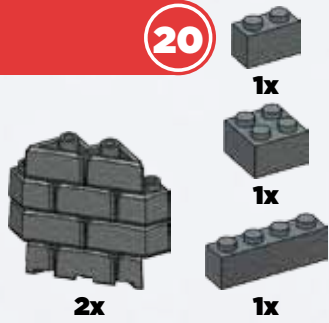

21

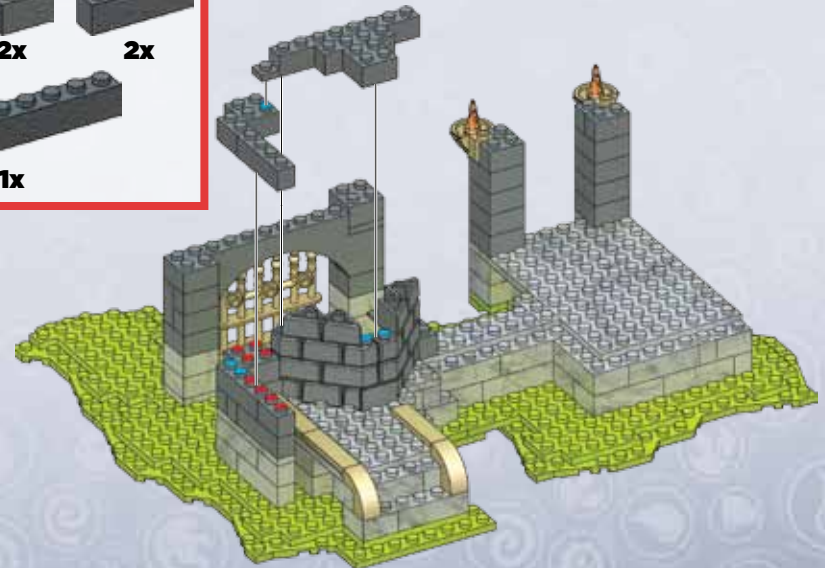
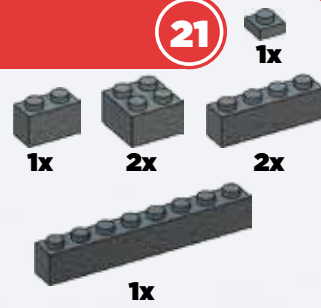

22



1x

2x

1x

23

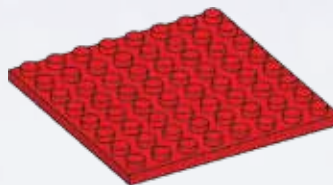

1x

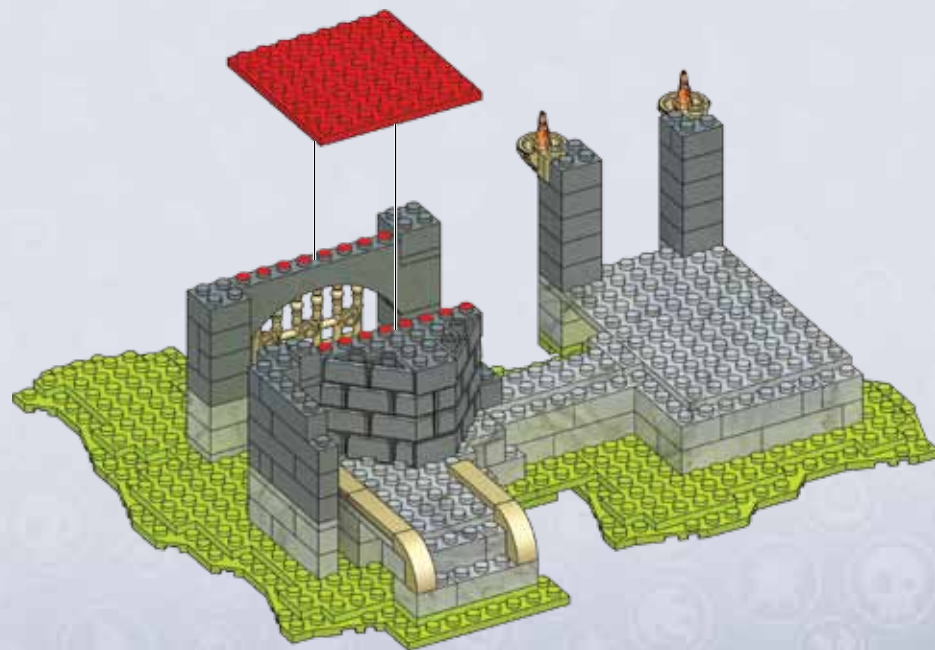
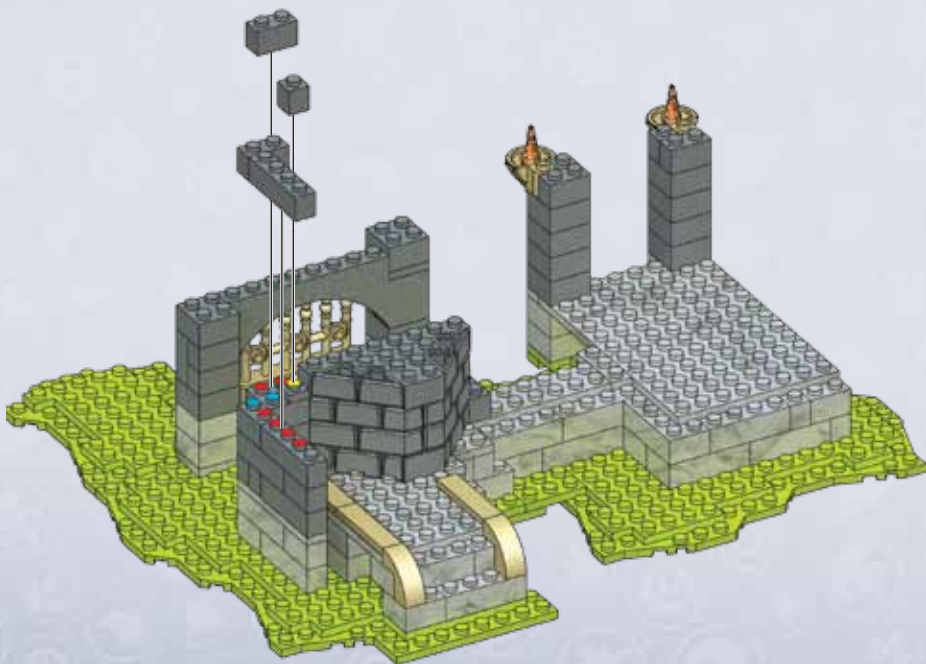

24



25

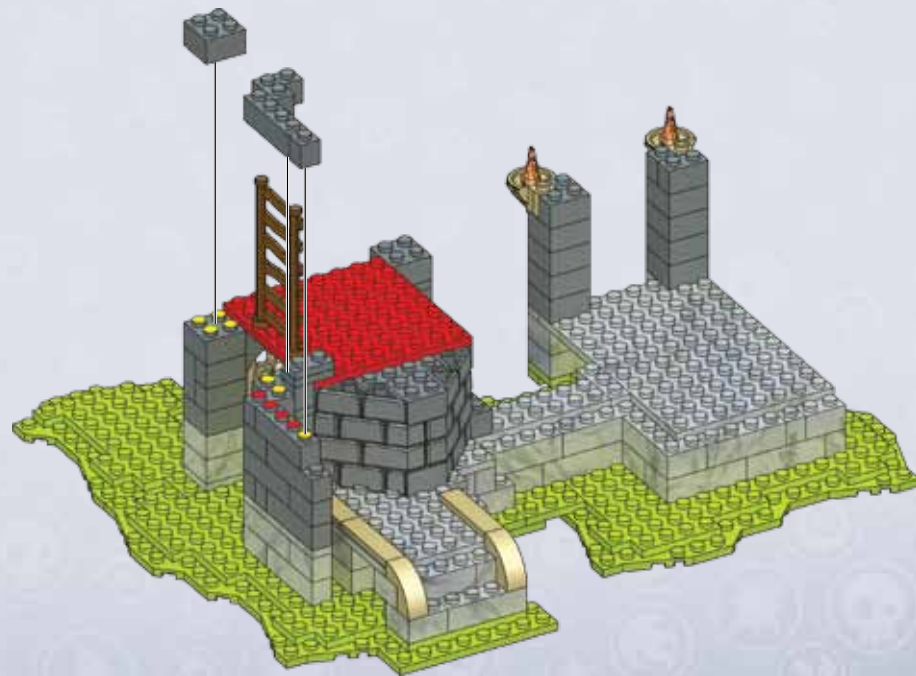
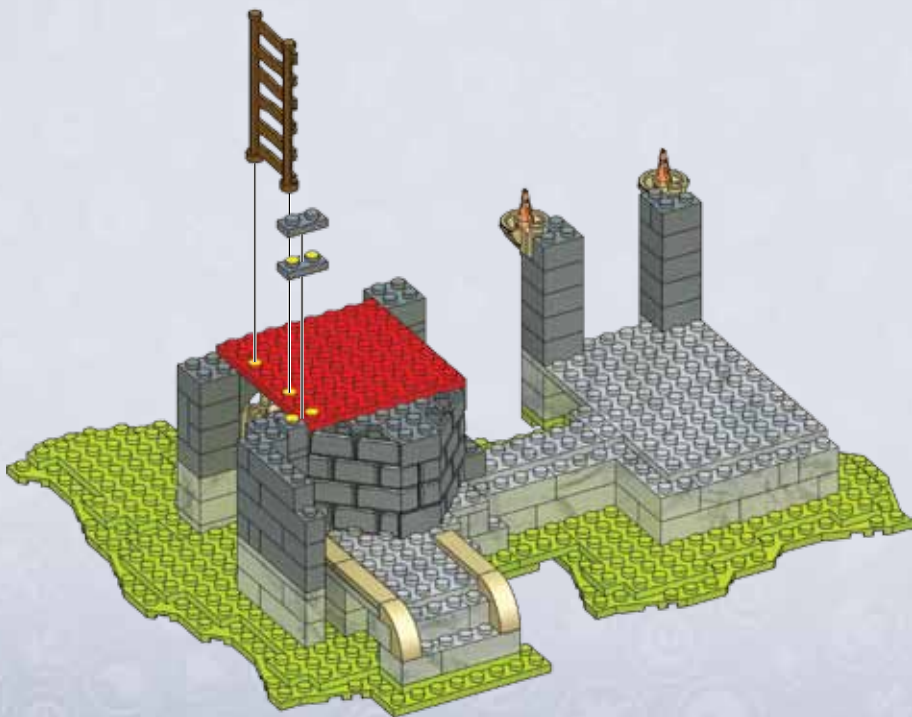
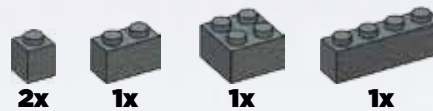

26



3x



1x

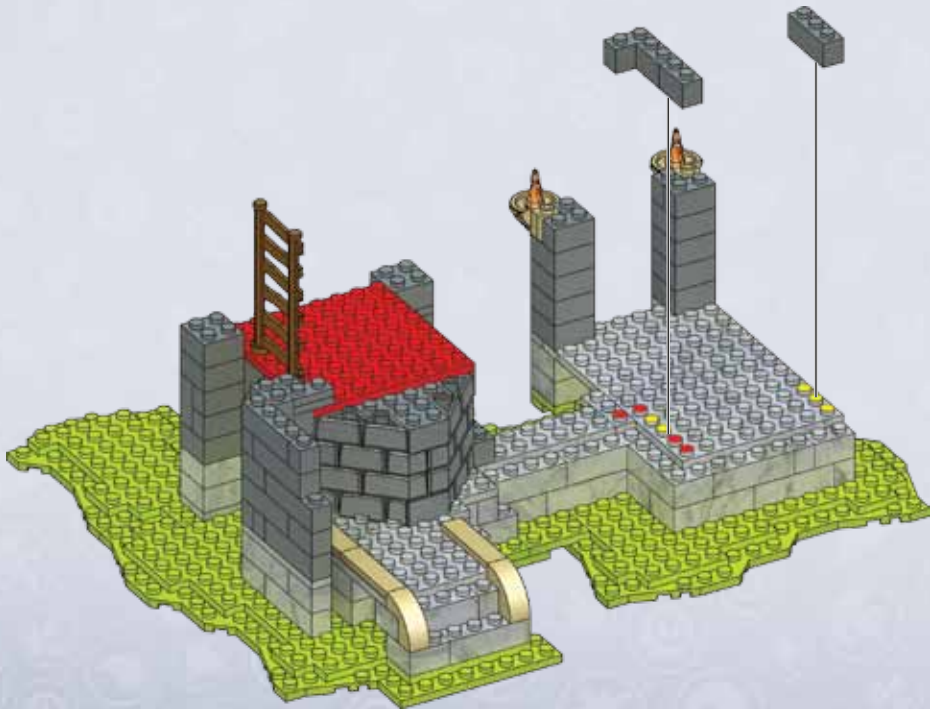

27



4x



6x

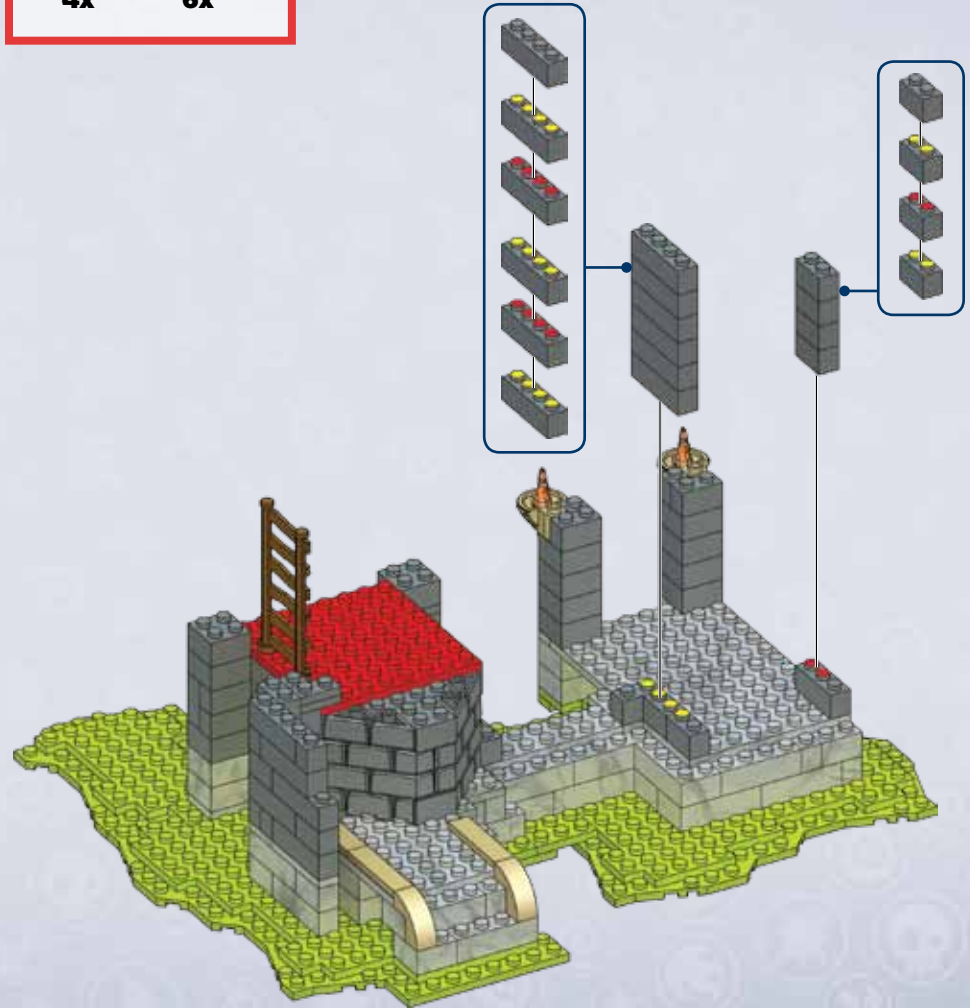

28



1x



1x



2x



1x

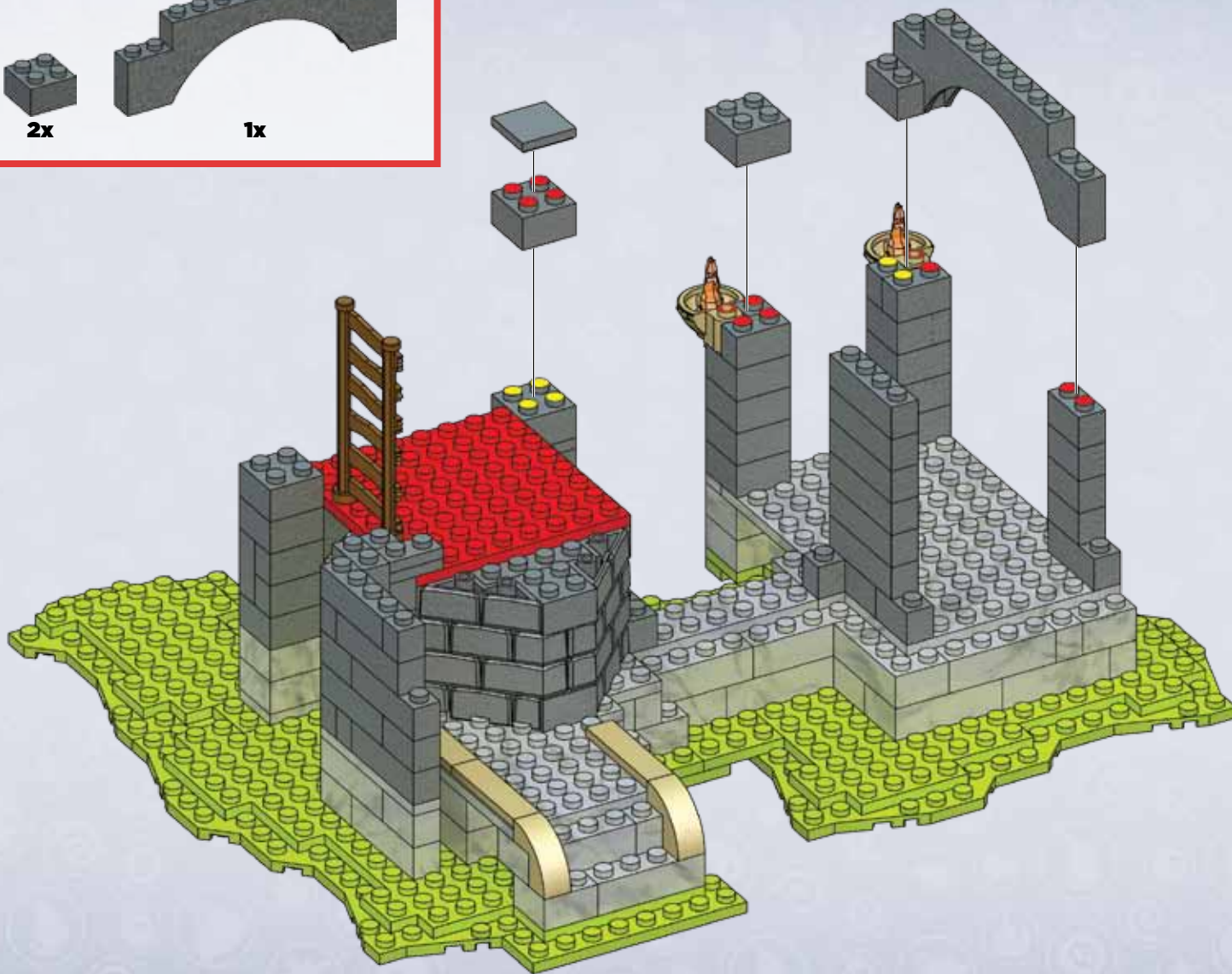

29



2x



1x



1x



30



2x



2x

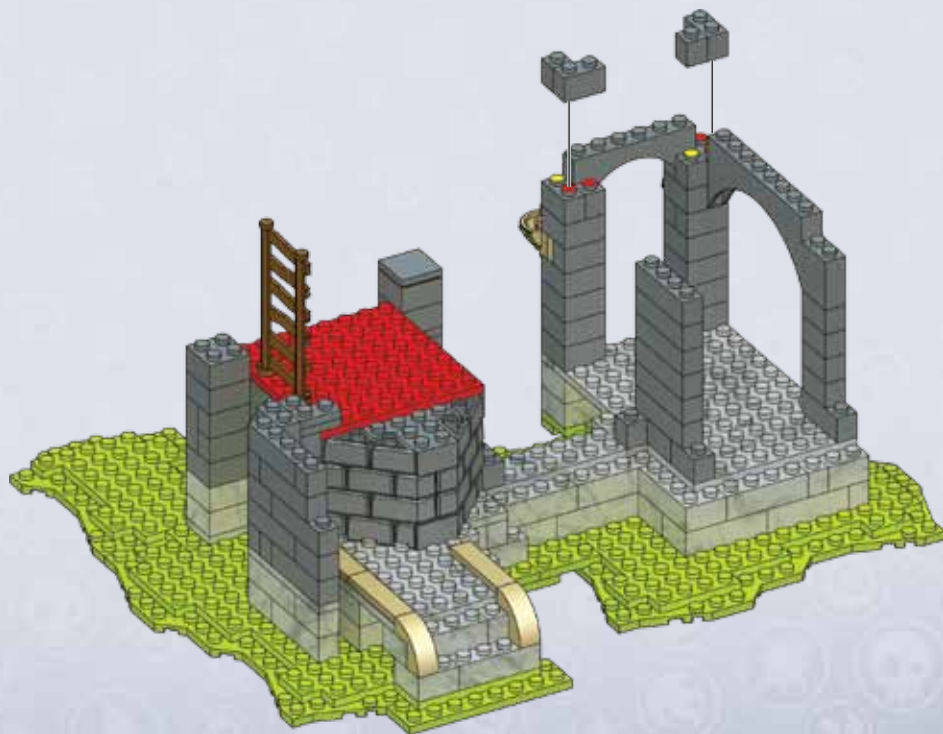

31

- 1x 
- 1x 
- 1x 
- 1x 
- 1x 

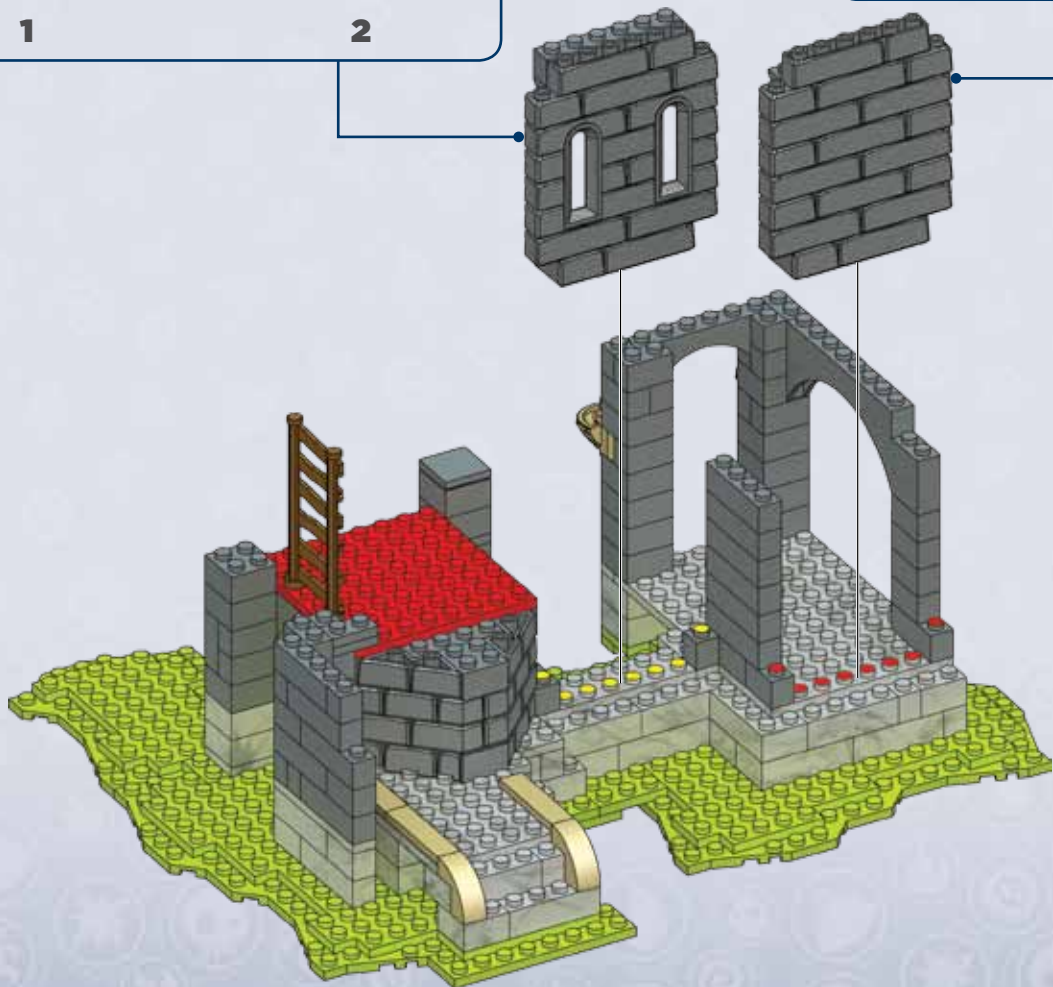
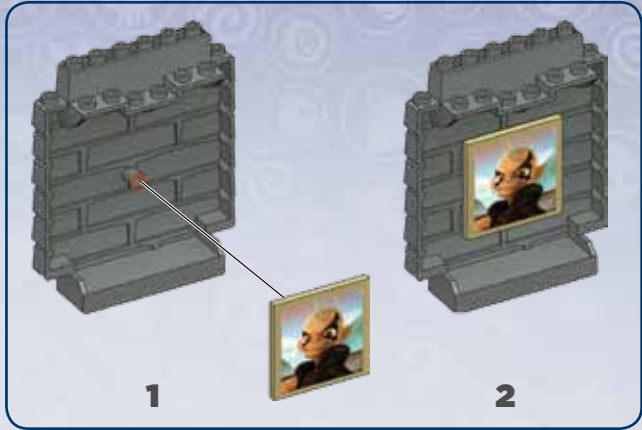
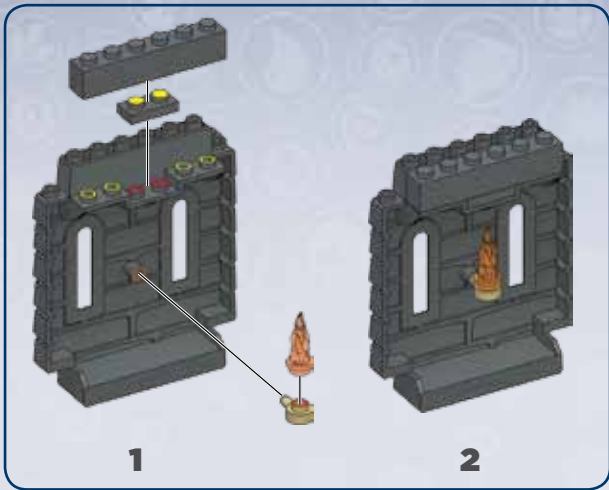
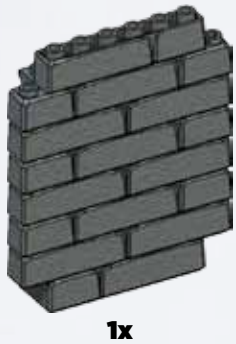

32



1x



1x



1x



1x



2x



2x

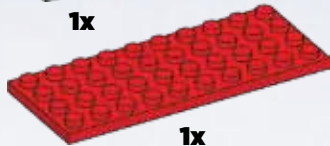

1x

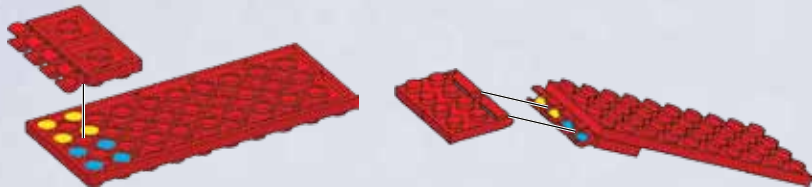

1

2



33



1x



1x

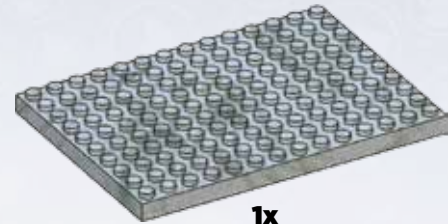

1x

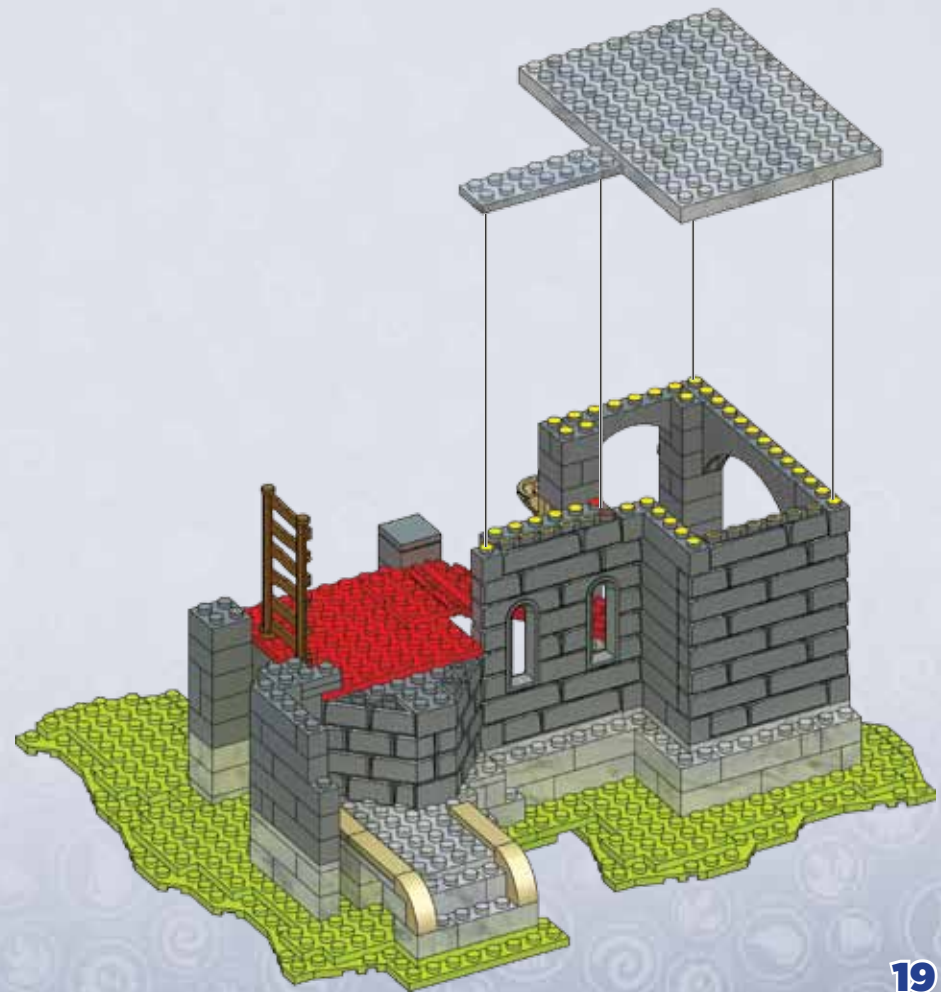

34



1x

1x

1x

35



2x

1x

1x

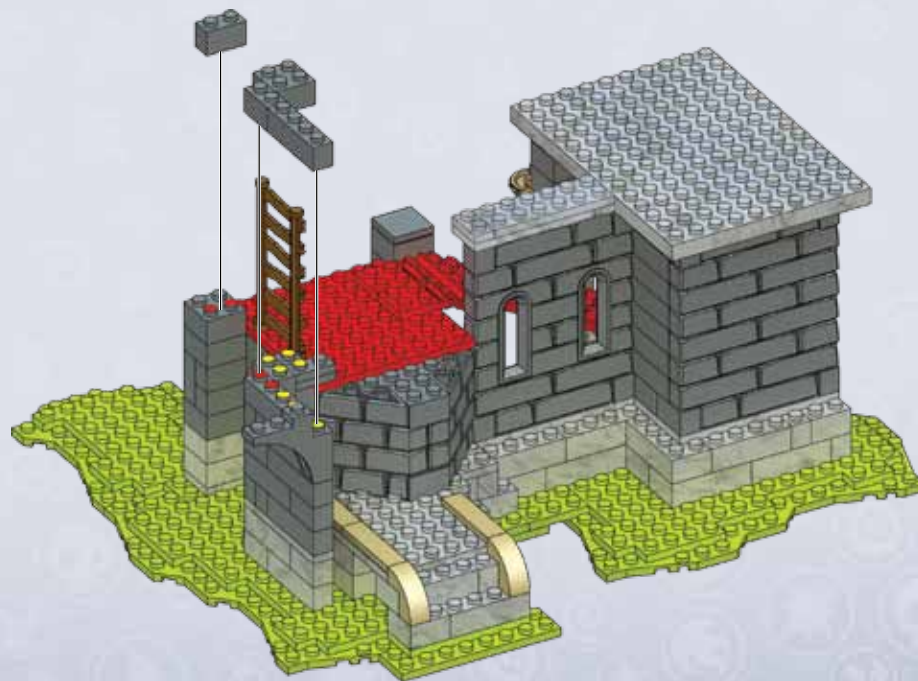
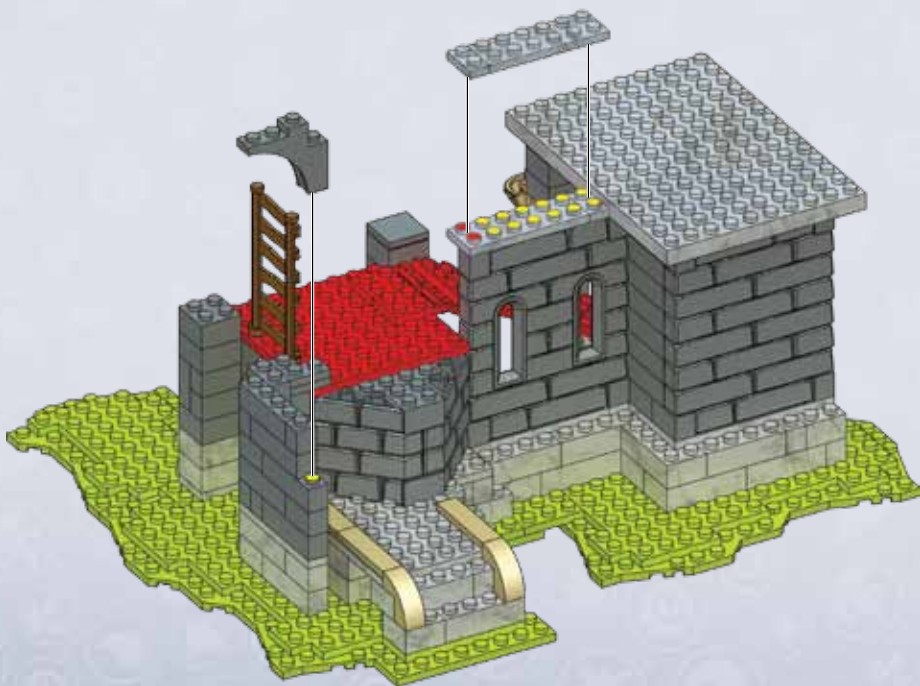

36



37

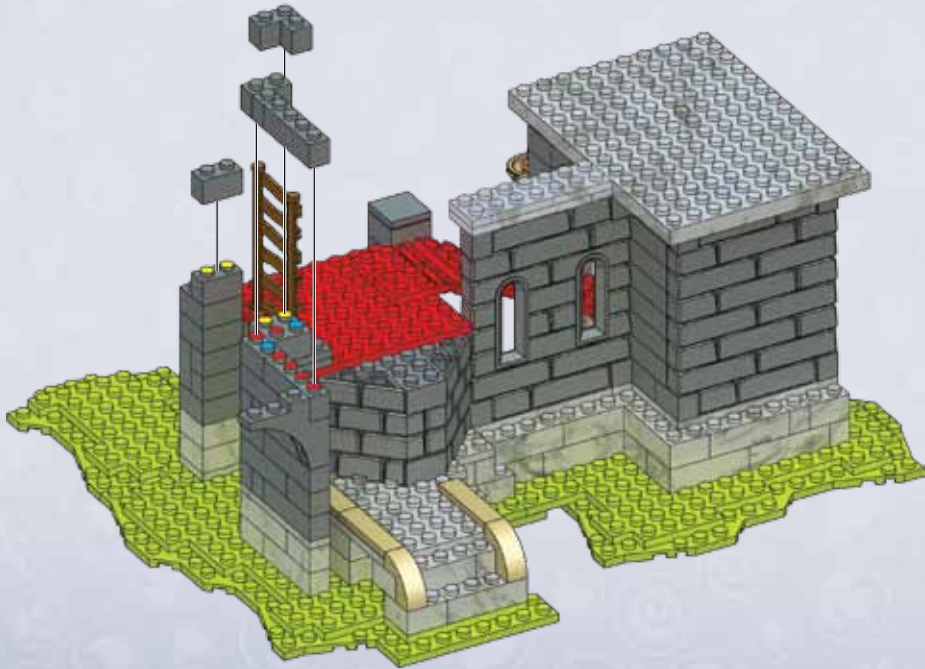

38



3x

1x

2x

39



2x

1x

2x



40



4x 2x 1x



41



5x 2x 3x

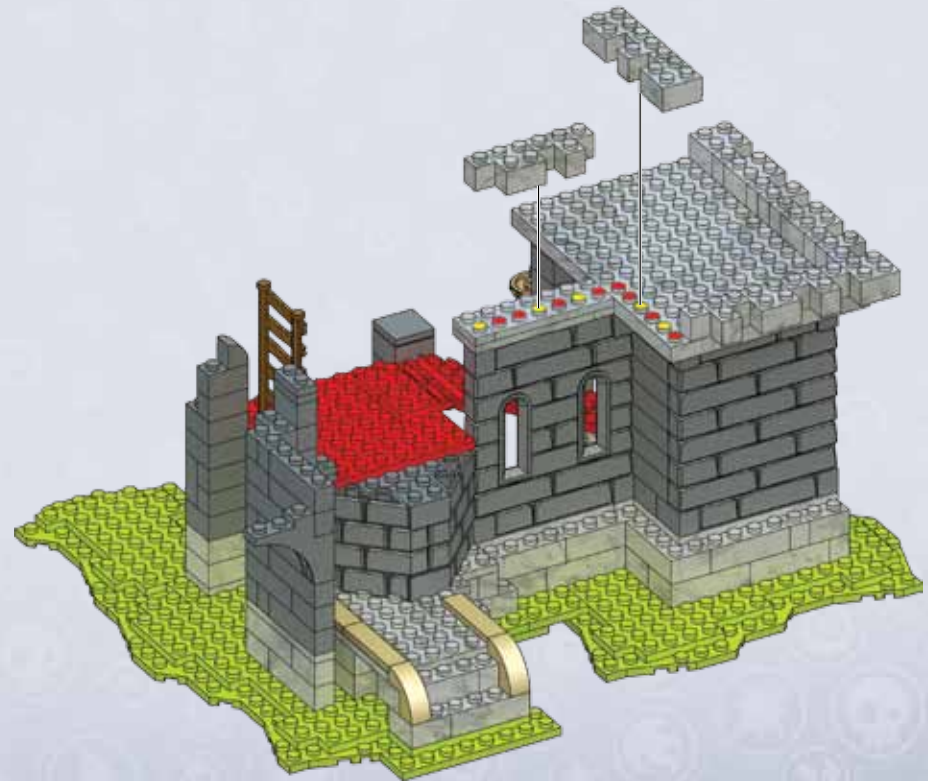

42



1x



4x

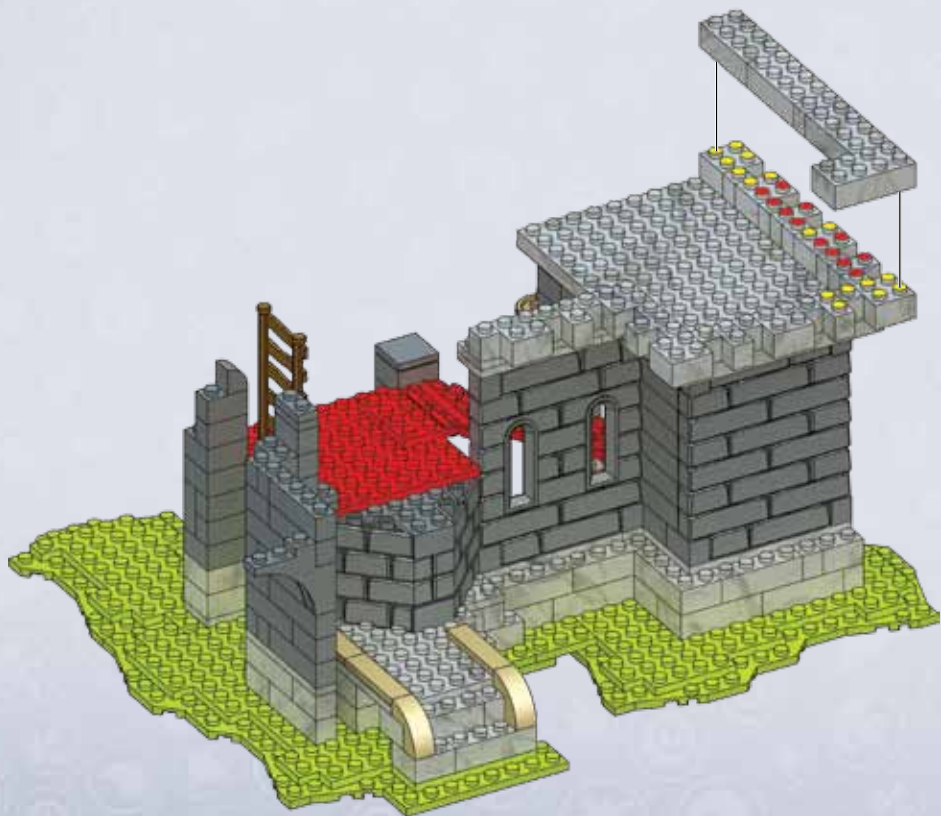

43



1x



4x

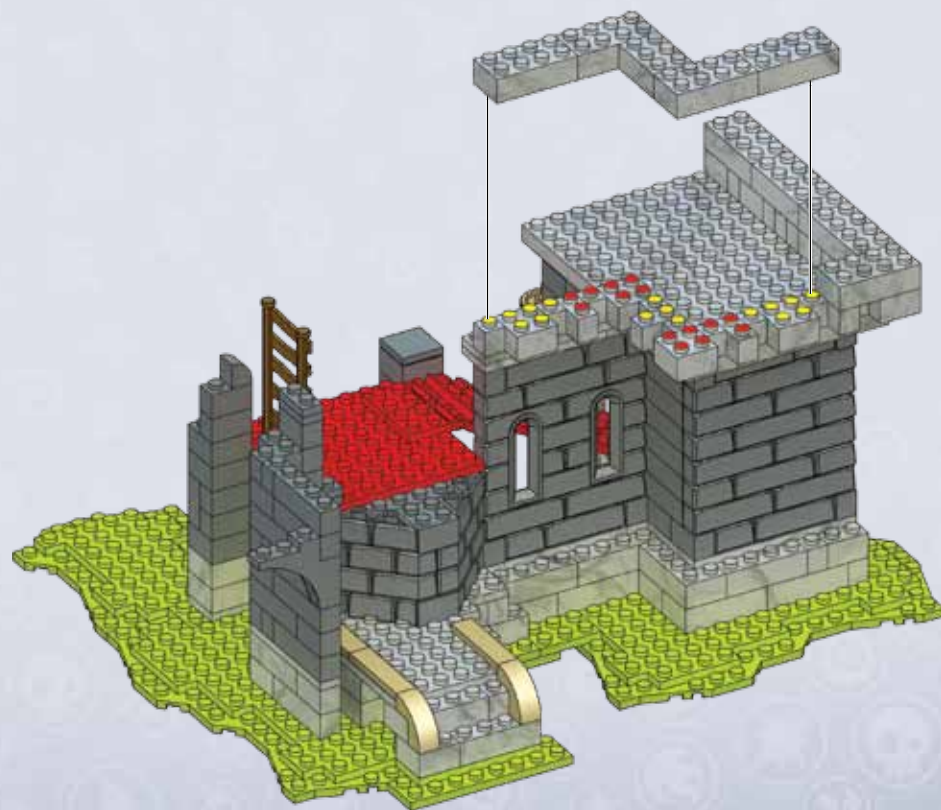

44



1x

1x

4x

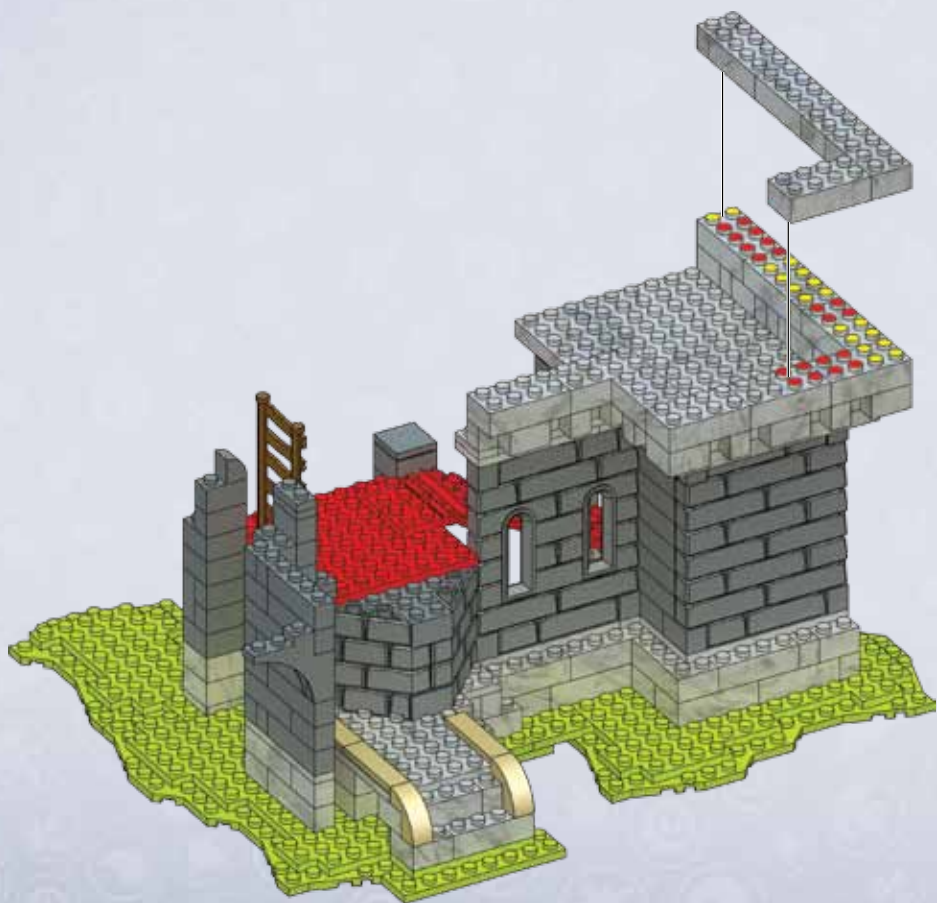

45

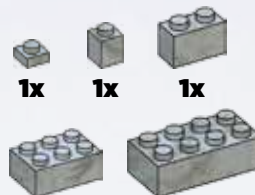

1x

1x

1x

1x

3x



46



2x



1x

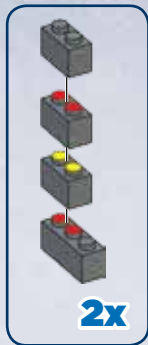

2x

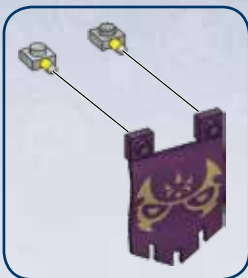

47



4x



2x



1x

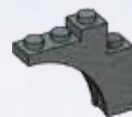

2x

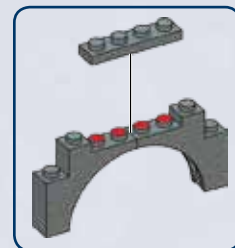

2x

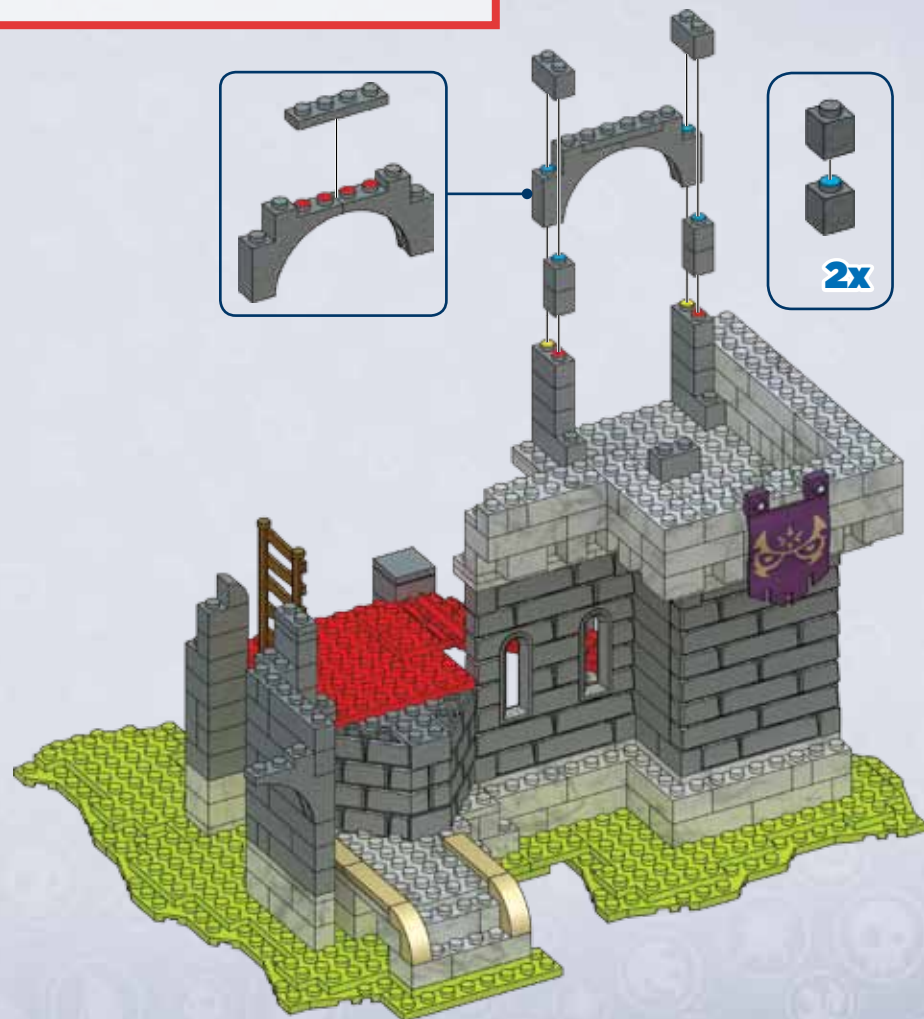
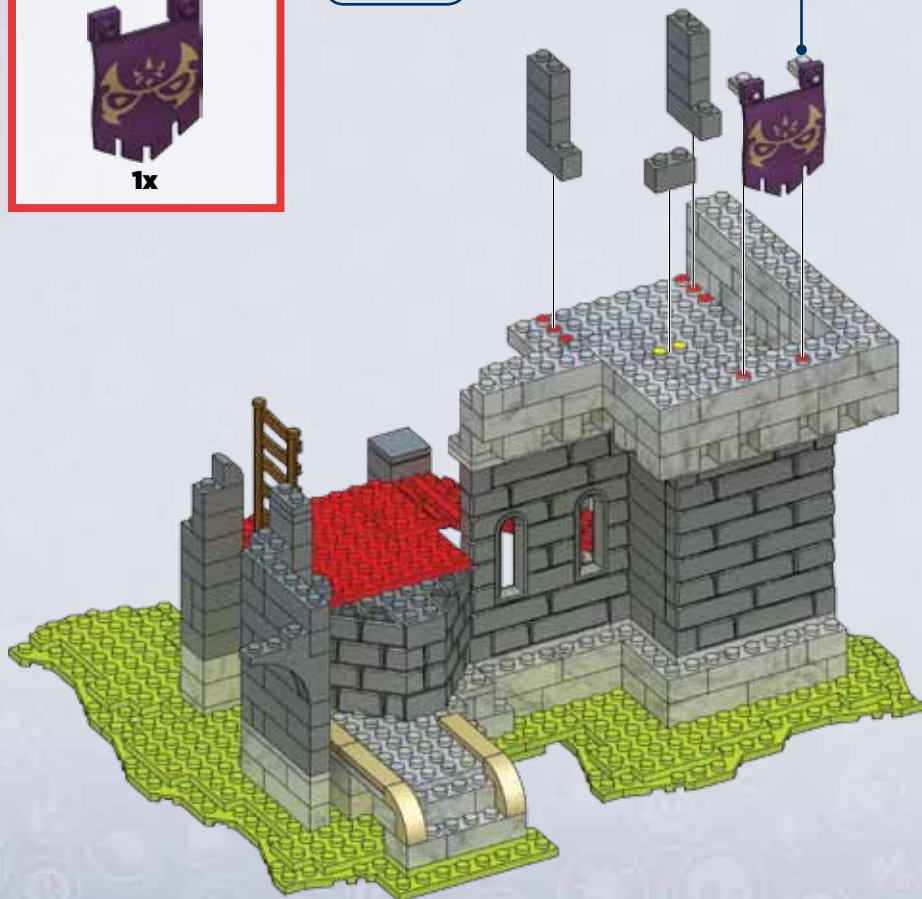

48



2x

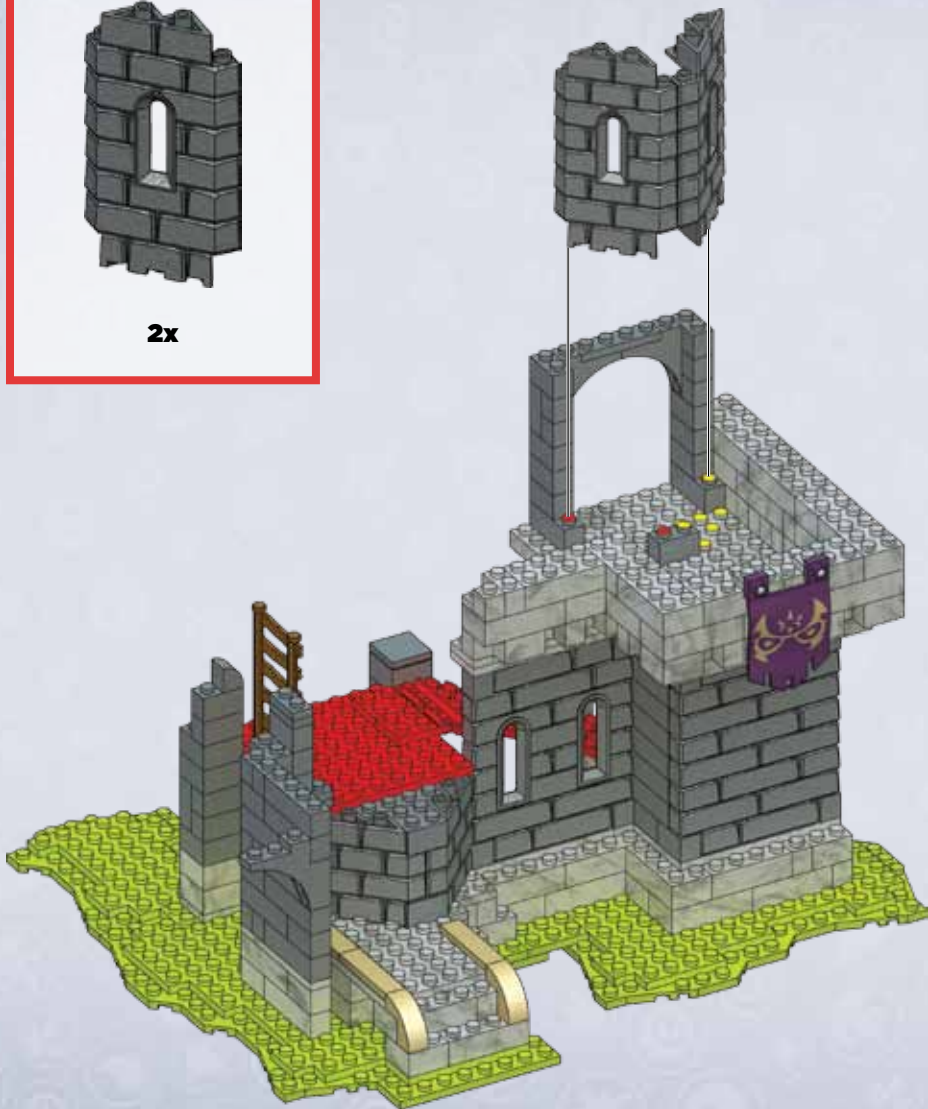

49



2x



2x



1x

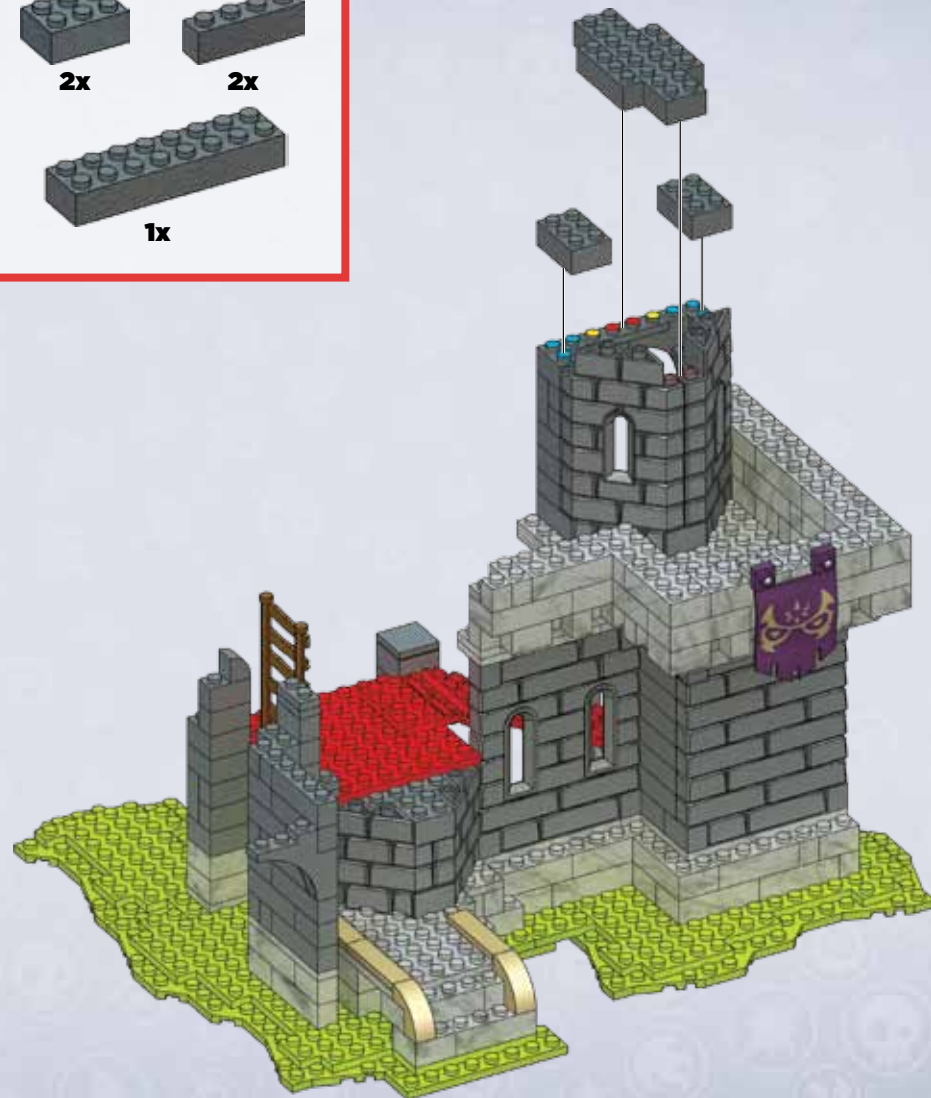

50



4x

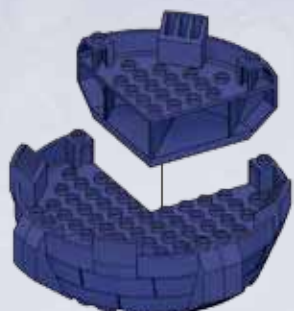

51



4x



5x



4x



4x



4x

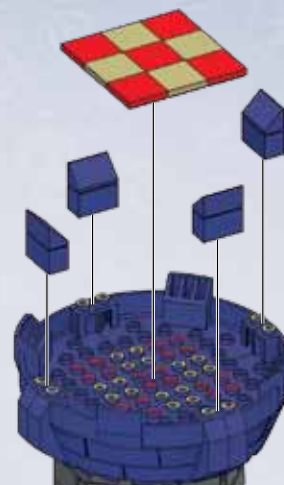

52



53

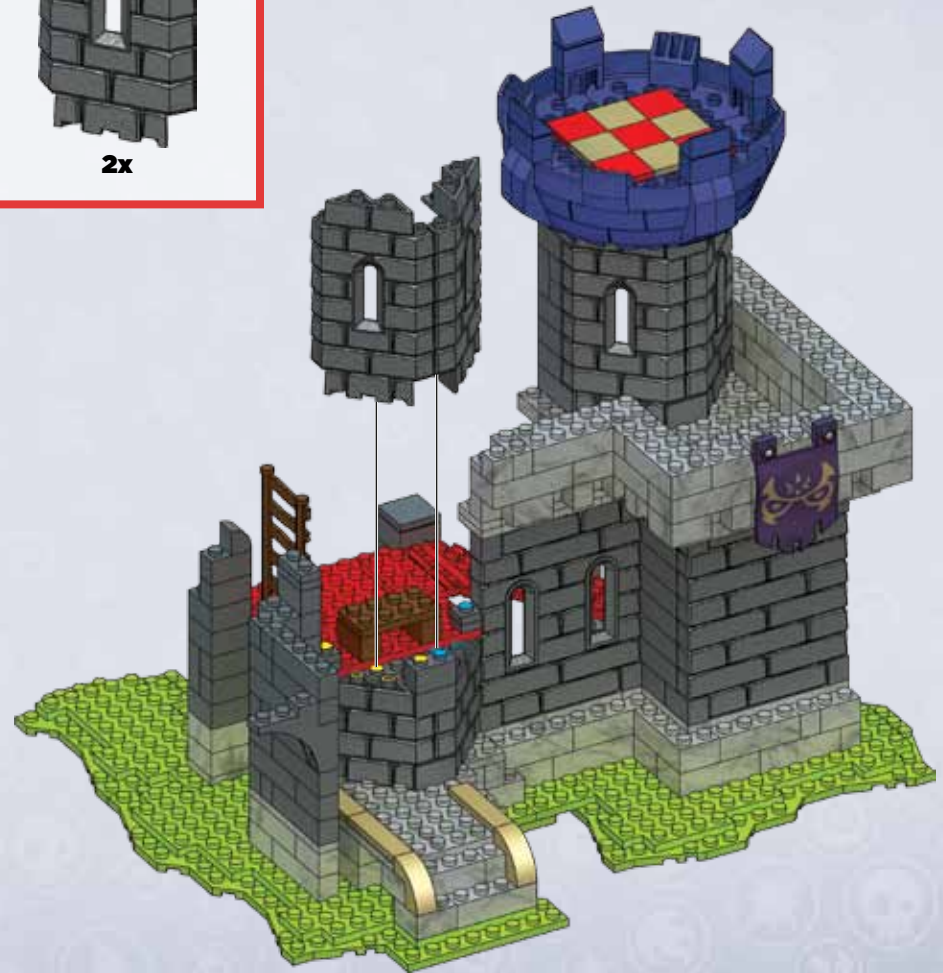

54



1x



1x



1x

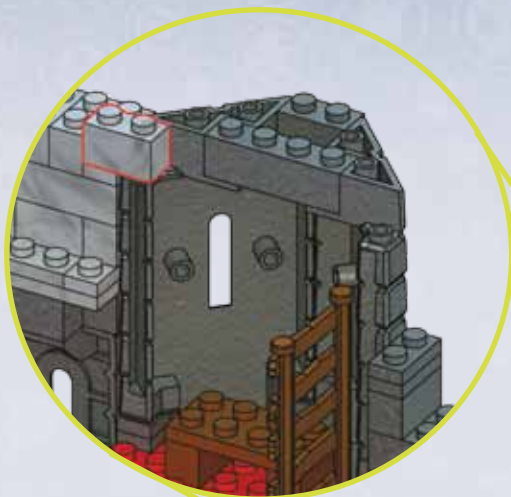



MEGA BLOKS



BUILD THE ADVENTURE!
¡CONSTRUYA SU AVENTURA!
CONSTRUISEZ VOTRE AVENTURE!

BAUE DIR DEIN EIGENES ABENTEUER!
 MAAK JE EIGEN AVONTUUR!
 COSTRUIRE LA VOSTRA AVVENTURA!
 CONSTRUA A SUA AVENTURA!

SUMMON THE ATTACK!
CONQUER THE FORTRESS!
¡CONVOCA EL ATAQUE!
¡CONQUISTA LA FORTALEZA!

PRÉPAREZ L'ATTAQUE ! PARTEZ À
 LA CONQUÊTE DE LA FORTERESSE !

BEFEH, DEN ANGRIF! VERTEIDIGE DIE FESTUNG!
 ZET DE AANVAL IN VERGROEV DE VESTING!
 ALL'ATTACCA! CONQUISTANO LA FORTALEZZA!
 ¡CONVOCA O ATAQUE! CONQUISTA A FORTALEZA!



© 2012, MEGA Brands Inc. ©
 & TM MEGA Brands Inc.
 Printed in Canada D954431A



© 2012 Activision Publishing, Inc.
 SKYLANDERS GIANTS is a trademark,
 and ACTIVISION is a registered trademark of
 Activision Publishing, Inc.



SKYLANDERS.MEGABLOKS.COM

COLLECT THEM ALL! / ¡COLECCIONALOS TODOS! / COLLECTIONNEZ-LES TOUS!
SHIPPEE 26 JULIET / VERBODEN DE WEDERAF / COLLEZIONARE TUTTI / COLECCIONAR OS TODOS

