



10335





LEGO.com/sustainable-packaging



FR
**DONNEZ
OU
RECYCLEZ**



ASSOCIATION

OU



MAGASIN

OU



DÉCHÈTERIE

Adresses sur quefairedemesdechets.fr



BUILDER



Apple and the Apple logo are trademarks of Apple Inc., registered in the U.S. and other countries and regions. App Store is a service mark of Apple Inc. Google Play and the Google Play logo are trademarks of Google LLC. Tencent and the Tencent logo are trademarks of Tencent Inc.

LEGO.com/devicecheck



LEGO® Builder



La riscoperta dell'*Endurance*

Nel 2022, cento anni dopo la morte di Sir Ernest Shackleton, il relitto della sua nave più leggendaria, l'*Endurance*, fu riscoperto sul fondale del Mare di Weddell al largo delle coste dell'Antartide. Varato per la prima volta nel 1912, l'ex yacht di lusso era stato ristrutturato per l'utilizzo negli ambienti più inospitali, proteggendo il suo equipaggio dagli elementi durante la spedizione imperiale trans-antartica di Shackleton nel 1914. L'audace missione della traversata dell'Antartide non fu portata a termine in quanto l'*Endurance* rimase bloccata nei ghiacci prima di poter raggiungere la sua destinazione. Il modo in cui il suo equipaggio sopravvisse alla disavventura, tuttavia, rimane ancora una delle storie più commoventi di resilienza umana, intraprendenza e spirito di squadra del secolo scorso. Mentre l'*Endurance* rimarrà per sempre nella sua "dimora" sottomarina, la riscoperta del relitto, straordinariamente ben preservato, riporta ancora una volta in superficie la sua incredibile storia. Divertitevi a costruire mentre celebriamo questa epica storia di sopravvivenza con uno splendido modello LEGO® Icons ricco di dettagli.



Il Trattato antartico

Il 1° dicembre 1959, dodici paesi firmarono il Trattato antartico per preservare il continente come centro indipendente per la ricerca scientifica. Secondo il trattato, senza nessun popolo indigeno in grado rivendicare la sovranità territoriale, nessun paese aveva l'autorità legale per rivendicare o tentare di recuperare l'Endurance.

Costruito per durare

/// La barca a tre alberi era dotata anche di un motore a vapore a tripla espansione per poter spingere la nave anche in caso di venti forti e ghiaccio.

*/// Grazie all'uso di una combinazione di legno di quercia, legno di pino e legno di *Chlorocardium rodiei* (un albero sempreverde) lo scafo era in grado di resistere anche alle condizioni più estreme.*

*/// Al momento della scoperta del relitto nel 2022, il nome *Endurance* in lettere dorate e la stella dorata erano ancora intatti.*



Tutti sopravvissuti

Il 5 dicembre 1914, Shackleton e il suo equipaggio salparono da Grytviken nella Georgia del Sud per una intrepida missione: raggiungere il Polo Sud in dodici mesi. Verso la fine di febbraio 1915, l'*Endurance* rimase inesorabilmente bloccata nella banchisa alla deriva nel Mare di Weddell. L'equipaggio stazionò a bordo fino al 27 ottobre 1915, nonostante il ghiaccio minacciasse di stritolare la nave. L'*Endurance* affondò il 21 novembre, distrutta dal ghiaccio.

I 28 uomini usarono le scialuppe di salvataggio per allestire il Patience Camp sulla banchisa dove rimasero fino all'aprile 1916, quando partirono su una scialuppa di salvataggio per l'Isola dell'Elefante. Ogni membro dell'equipaggio poté portare con sé solo un chilo di effetti personali, oltre a un banjo, che Shackleton pensava avrebbe svolto un ruolo fondamentale per la salute mentale dei suoi uomini! Dall'Isola dell'Elefante, Shackleton e alcuni dei suoi uomini completarono un'ultima tappa di due settimane per tornare in Georgia del Sud; tuttavia, approdarono sulla parte meridionale dell'isola – quella sbagliata – a causa di una forte tempesta e dovettero raggiungere a piedi la stazione baleniera di Stromness, una traversata che durò ben 36 ore. Qui, Shackleton organizzò i soccorsi, ma ci vollero quasi quattro mesi e mezzo e diversi tentativi per salvare i suoi ultimi uomini sull'Isola dell'Elefante.

La sopravvivenza dell'equipaggio dell'*Endurance* fu sicuramente dovuta alla straordinaria leadership di Sir Ernest Shackleton, senza dimenticare la sua eroica abnegazione e il suo ottimismo che tenne su il morale dei suoi uomini. Se qualcuno non aveva i guanti, Shackleton non esitava a prestare i suoi, se un uomo era stanco, veniva immediatamente mandato a riposarsi. Questi atteggiamenti altruisti, e la sua determinazione nel riportare tutti quanti a casa vivi, gli consentirono di conquistare la cieca fiducia del suo equipaggio.



*“By Endurance
We Conquer.”*

– Il motto della
famiglia Shackleton



Isola dell'Elefante

Il 15 aprile 1916, Shackleton e i suoi uomini raggiunsero la terraferma dopo 497 giorni. Si trattava dell'Isola dell'Elefante, dove gli ultimi membri dell'equipaggio furono salvati il 30 agosto 1916.

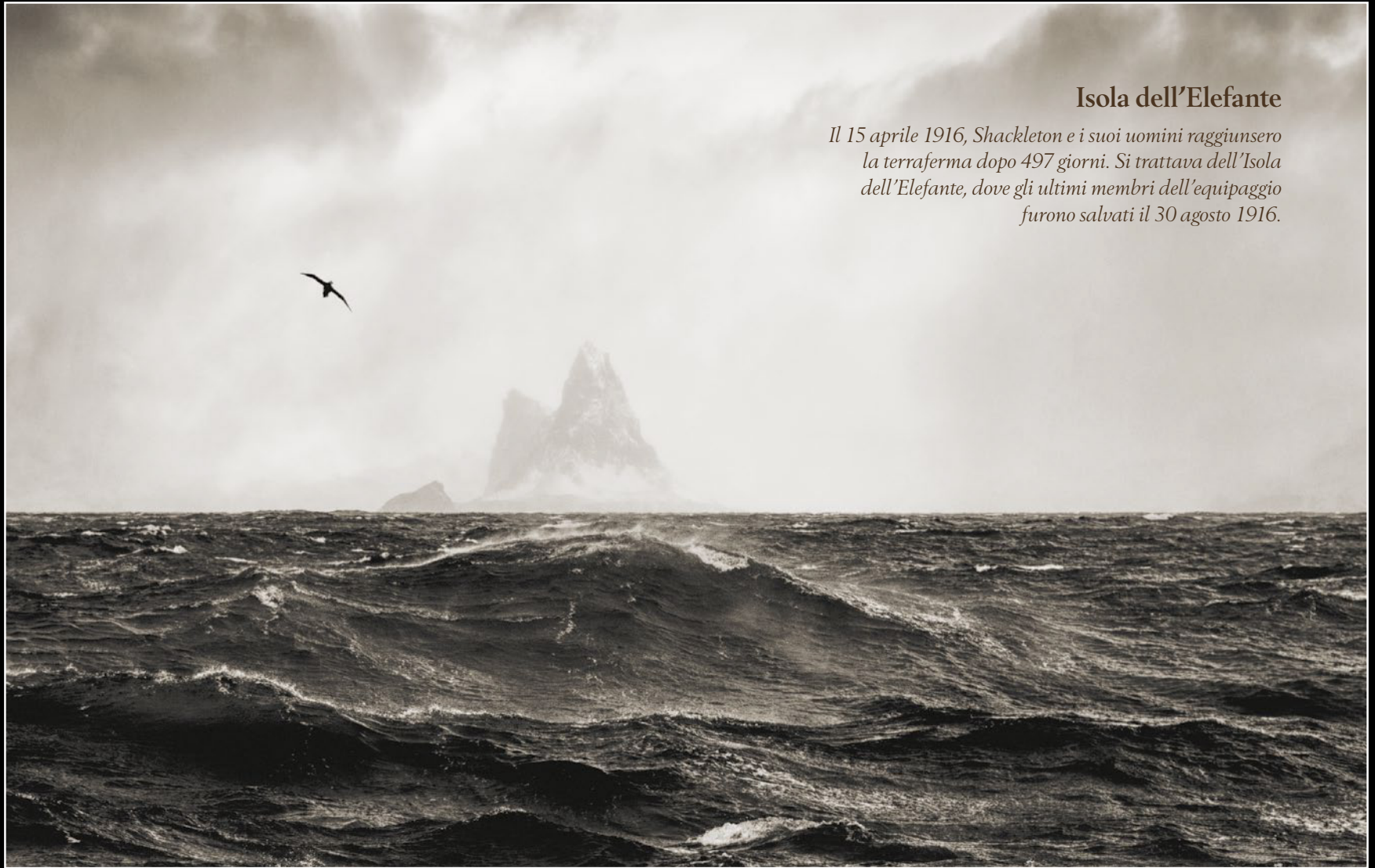

Il viaggio

- 1 5 dicembre 1914 - L'*Endurance* parte da Grytviken, nella Georgia del Sud.
- 2 18 gennaio 1915 - Dopo aver navigato per settimane nel gelido Mare di Weddell, l'*Endurance* rimane intrappolata nella banchisa.
- 3 21 novembre 1915 - Lo scafo comincia a sgretolarsi sotto la pressione dei ghiacci e la nave affonda al largo della costa antartica dopo alcune settimane.
- 4 15 aprile 1916 - Due settimane dopo aver lasciato il Patience Camp su una delle scialuppe di salvataggio, l'equipaggio approda sull'Isola dell'Elefante.
- 5 21 maggio 1916 - Shackleton e i primi membri dell'equipaggio raggiungono la Georgia del Sud.
- 6 30 agosto 1916 - Gli ultimi membri dell'equipaggio vengono finalmente salvati dall'Isola dell'Elefante.



Il Design Team LEGO®

“Per determinare la scala del modello, abbiamo innanzitutto scelto un dettaglio significativo, le scialuppe di salvataggio (disponibili in due diverse dimensioni) e le abbiamo costruite nel modo più dettagliato possibile, mantenendo al minimo le dimensioni. Abbiamo quindi calcolato quali sarebbero state le dimensioni della nave. Sebbene nella vita reale l'Endurance aveva spazio per 28 uomini, l'abbiamo ridimensionata un po' per includere le cabine di Sir Ernest Shackleton e di uno scienziato della spedizione. L'interno rivela anche il motore a vapore della nave, che può essere smontato. Nell'imbarcazione vera, il motore a vapore era grande quanto una casa a due piani! I modelli da esposizione LEGO® Icons di solito presentano funzioni interessanti e volevamo che il timone potesse essere azionato tramite il timone di bordo. Per questa funzione abbiamo creato un minuscolo ingranaggio di trasmissione basato su una piastra angolare che ora è disponibile per la prima volta in marrone scuro. È una delle numerose modifiche cromatiche degli elementi che abbiamo apportato per conferire alla nave il suo aspetto autentico. Dopo tutto, l'Endurance è stata una delle navi in legno più robuste mai costruite e merita un tributo adeguato!”

*Hans Burkhard Schlömer,
LEGO® Model Designer*



*“Dopo tutto,
l'Endurance è stata
una delle navi in
legno più robuste mai
costruite e merita un
tributo adeguato!”*



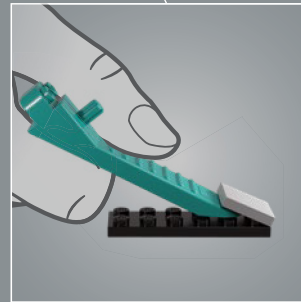
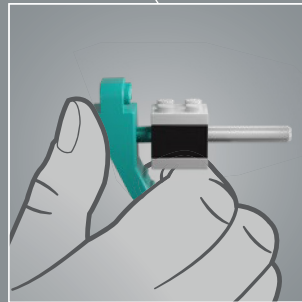
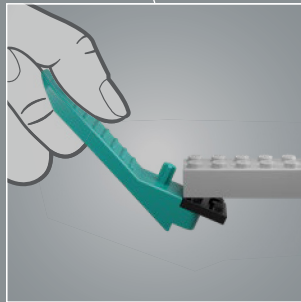
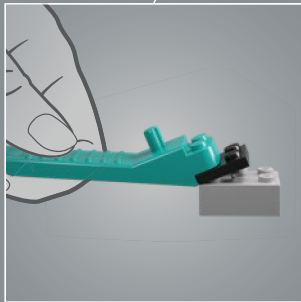
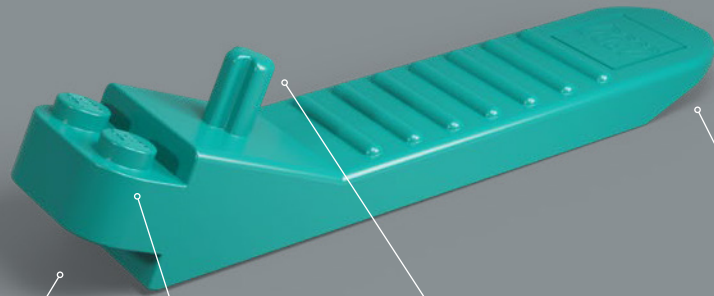

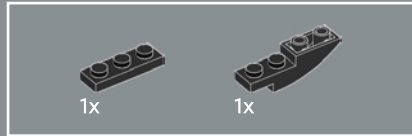

1

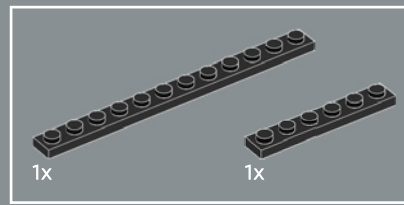
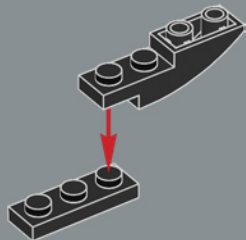

2

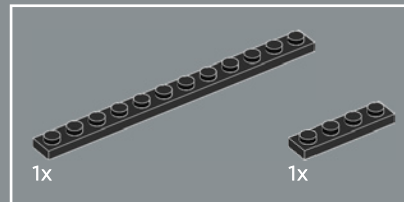
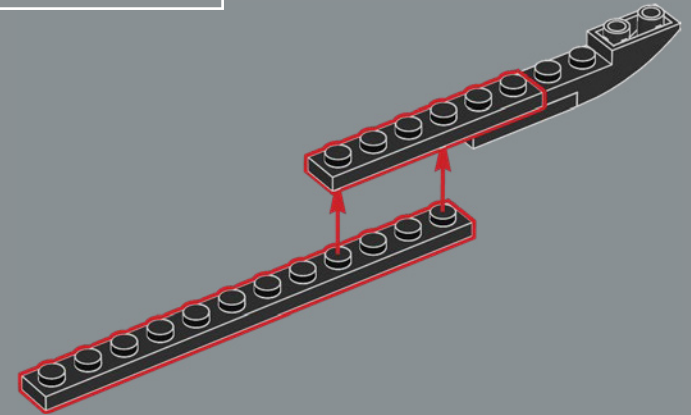

3

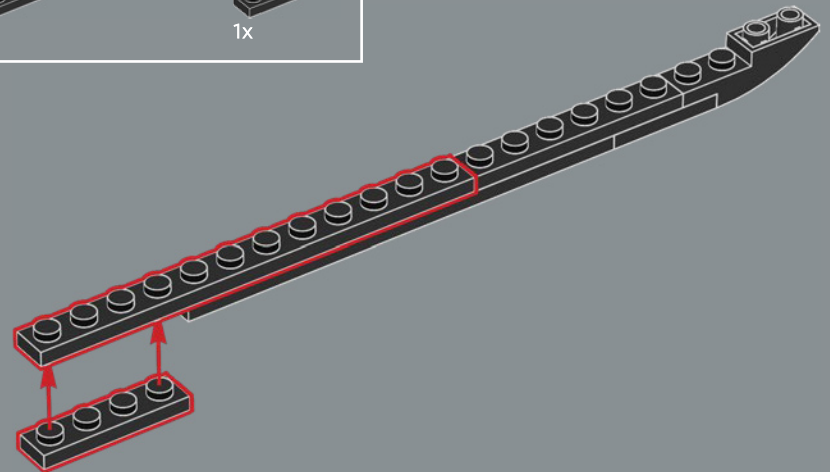

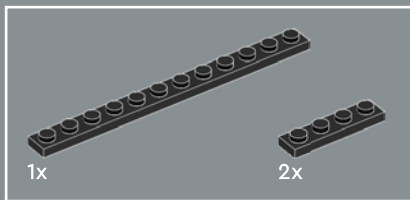

4

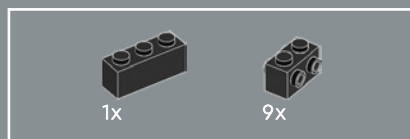
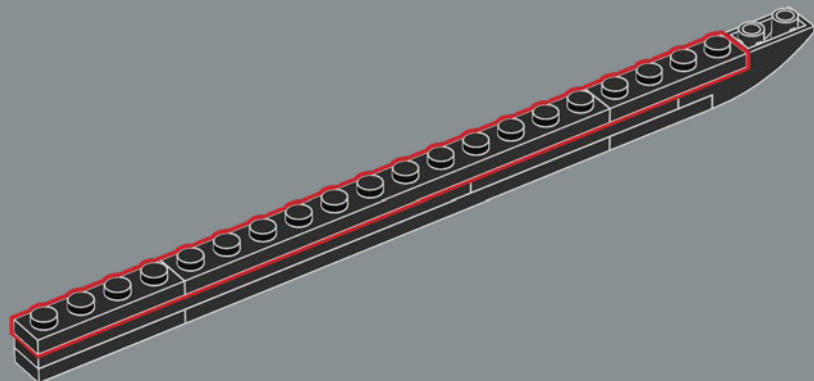

5

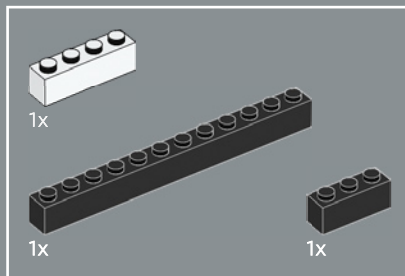
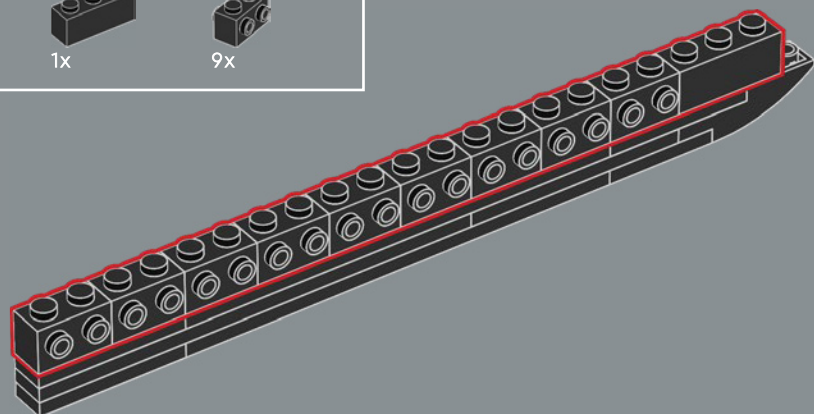

6

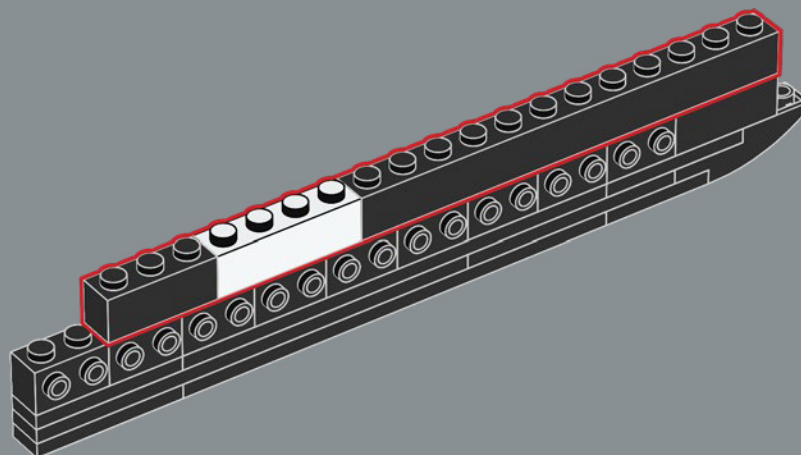

La chiglia è larga solo un mattoncino per preservare l'aspetto aerodinamico della nave, formando una parete nella sezione anteriore con mattoncini orientati lateralmente. Questa tecnica ha consentito di creare una forma attraente per lo scafo.



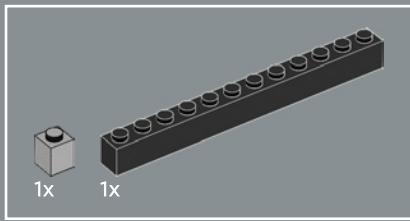

7

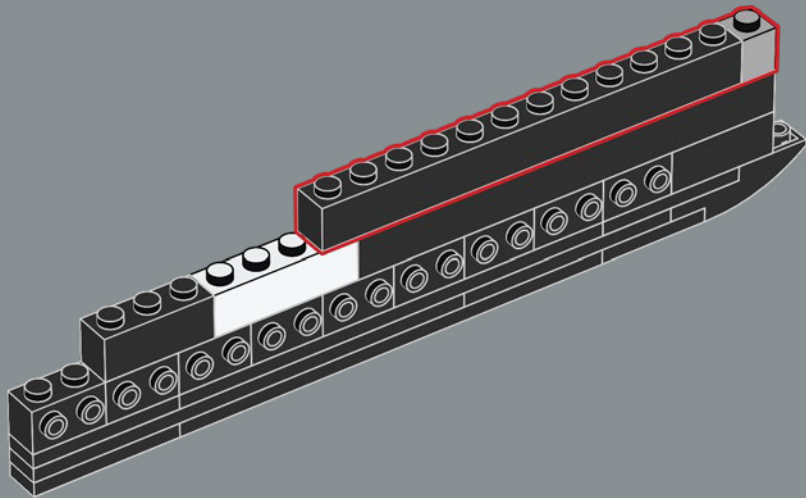

8

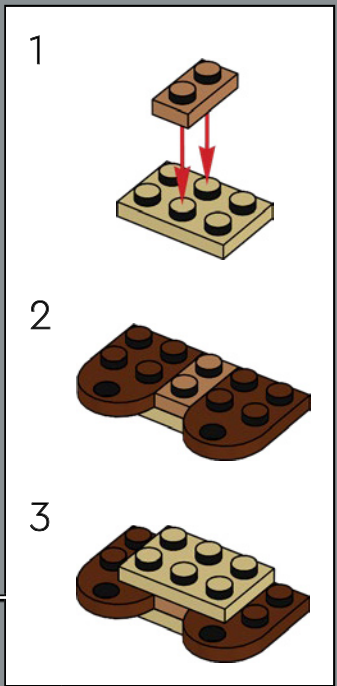
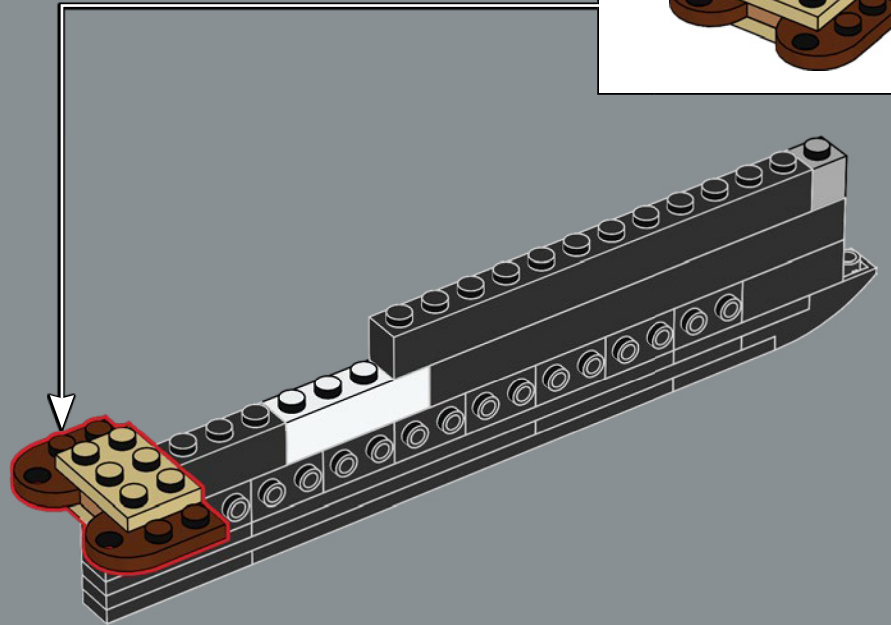

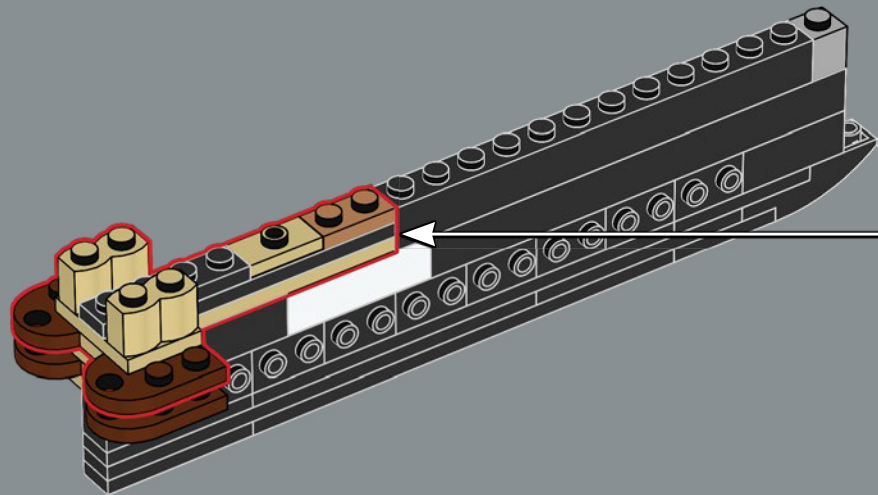
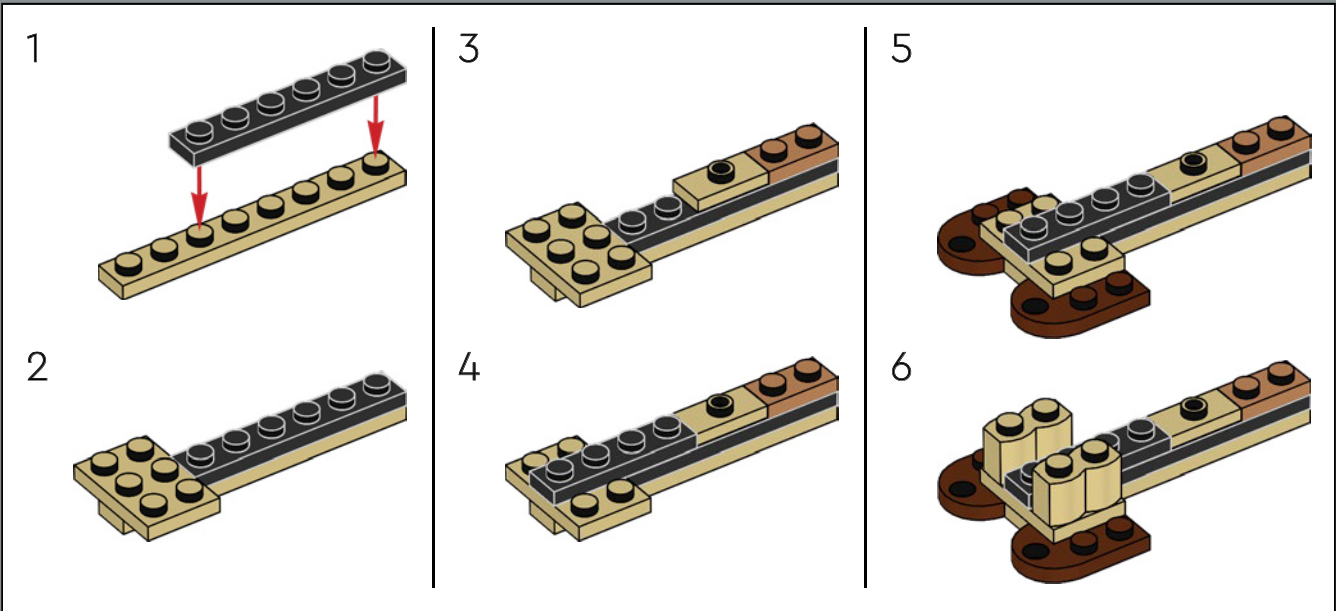
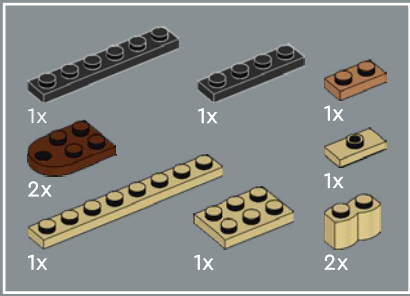

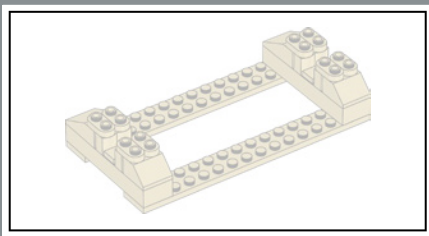

Poiché la chiglia è piuttosto stretta, è possibile utilizzare il supporto marrone per la costruzione per mantenere stabile il modello durante l'assemblaggio.

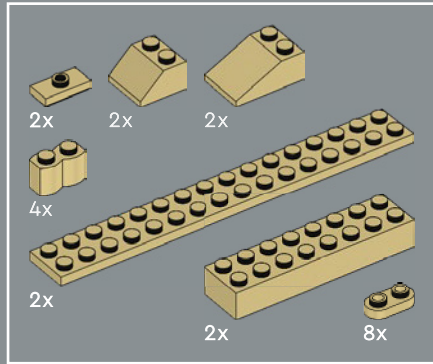

10

1

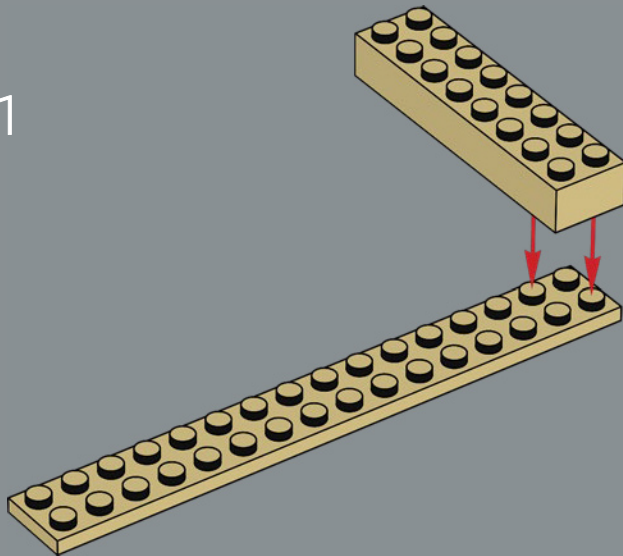

2

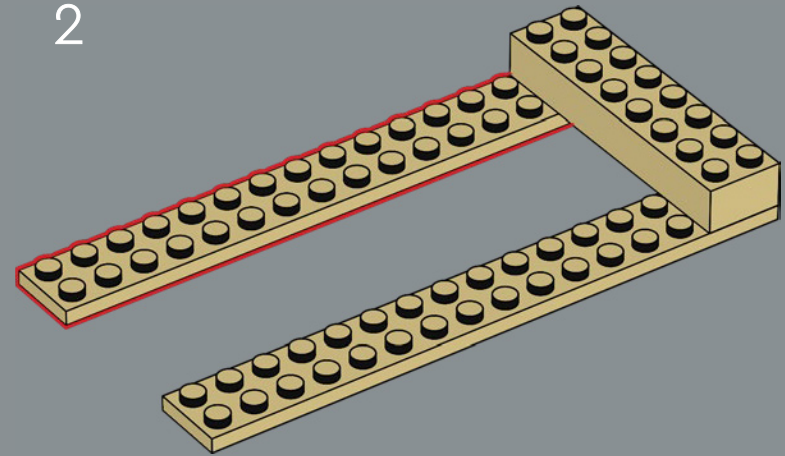

3

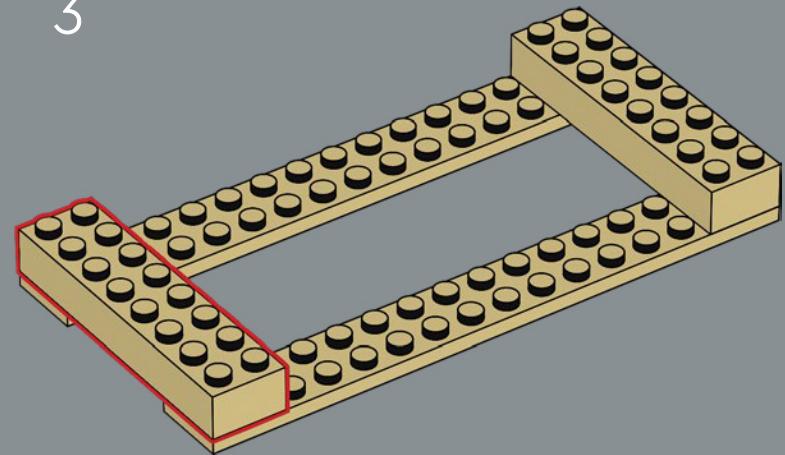

4

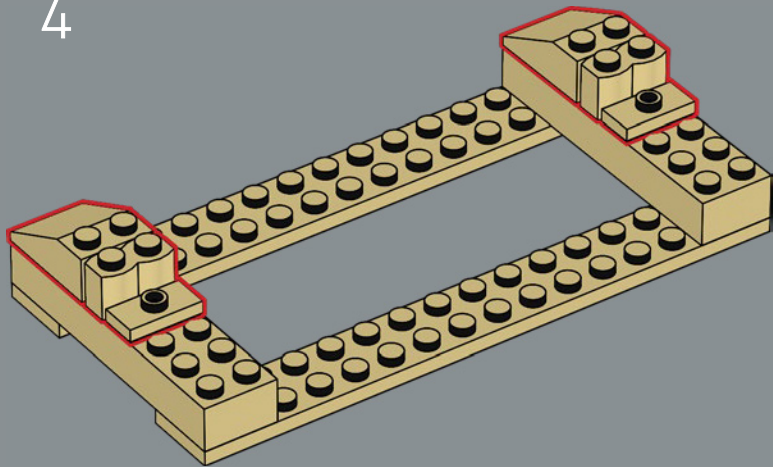

6

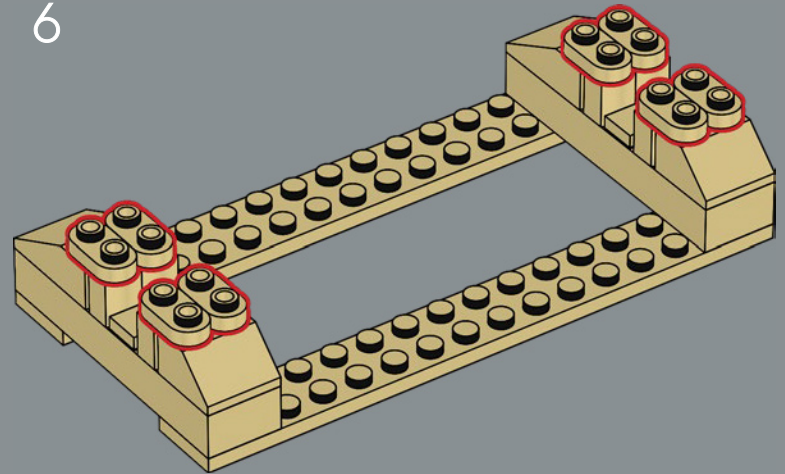

5

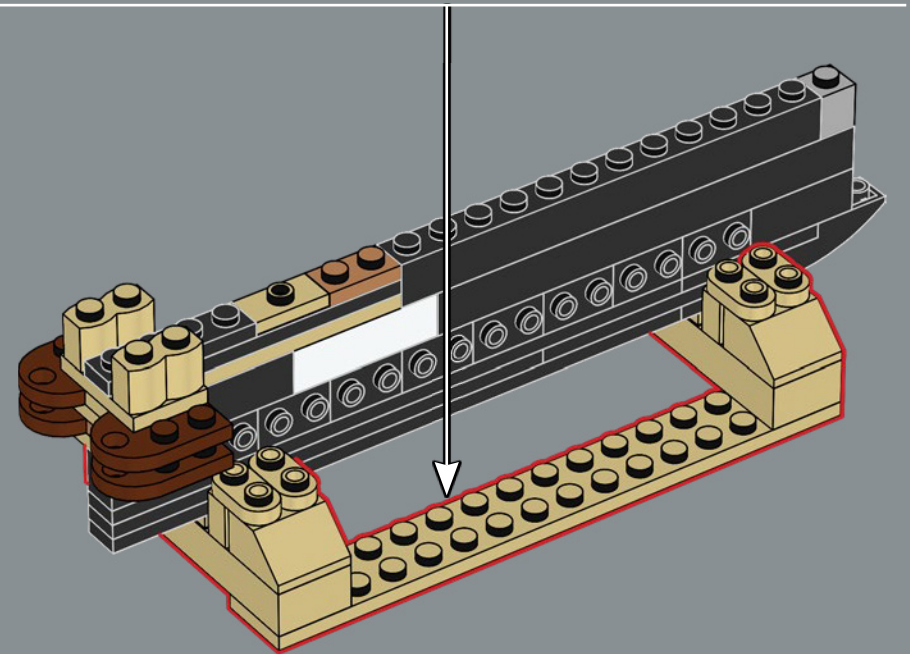
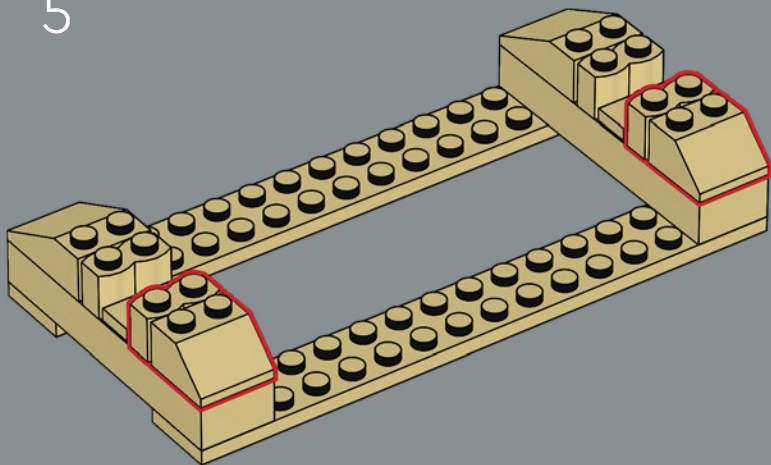

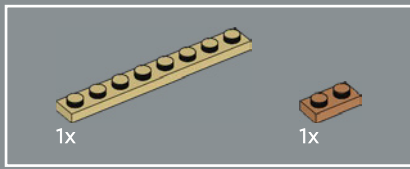

11

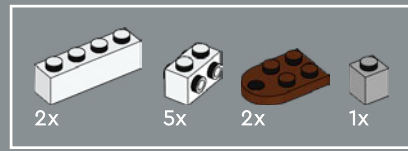
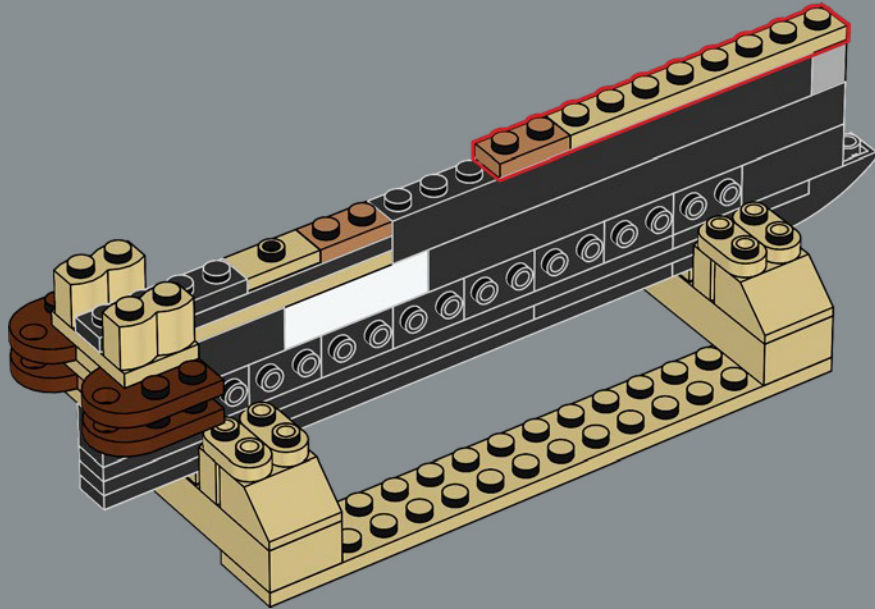

12

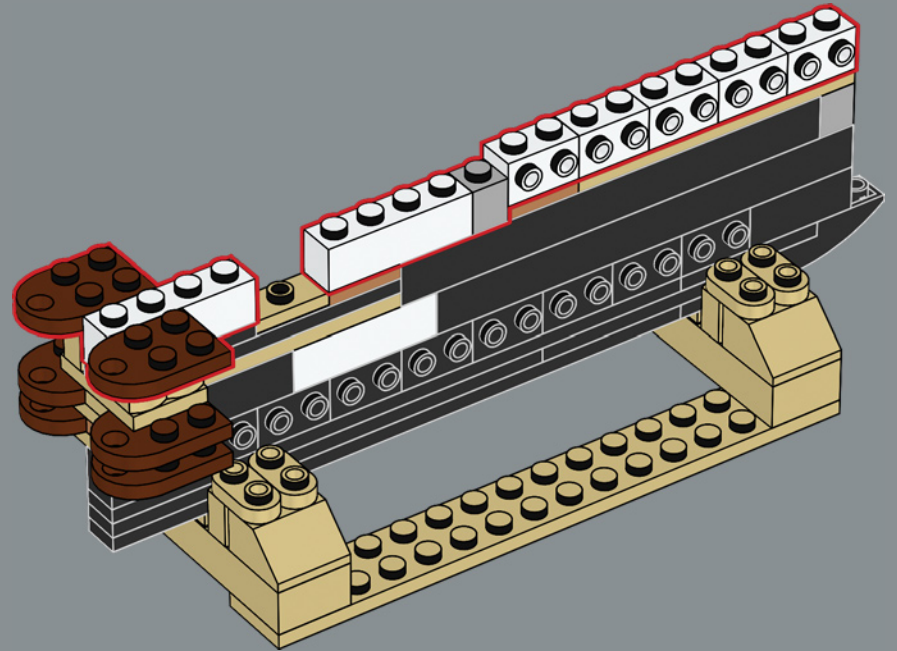

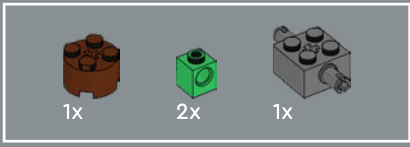

13

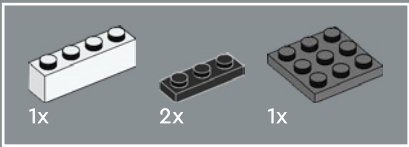
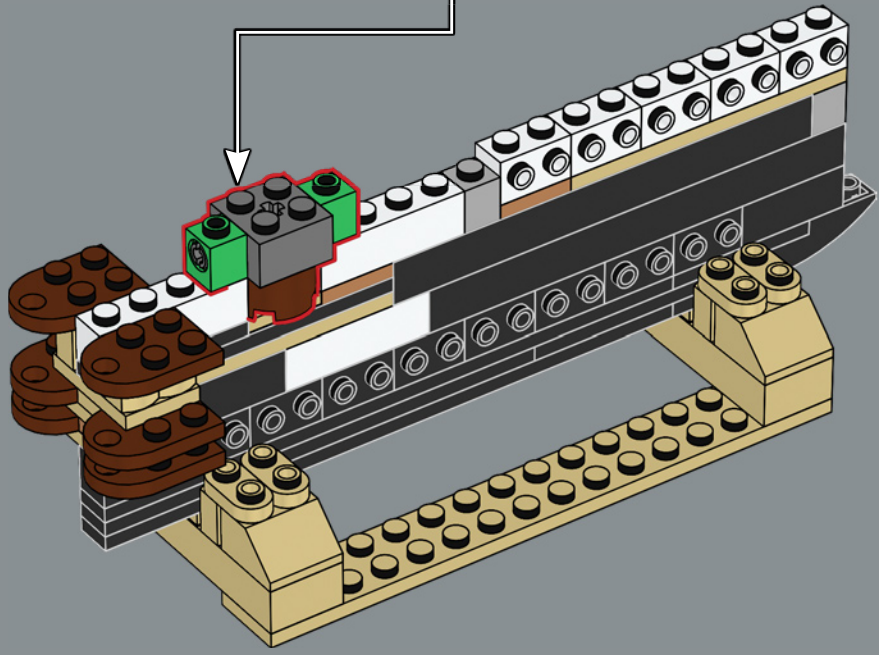
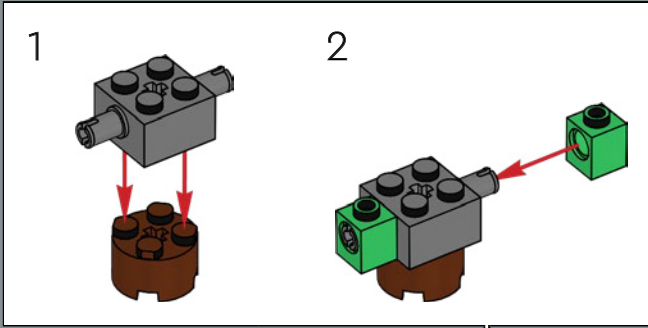

14

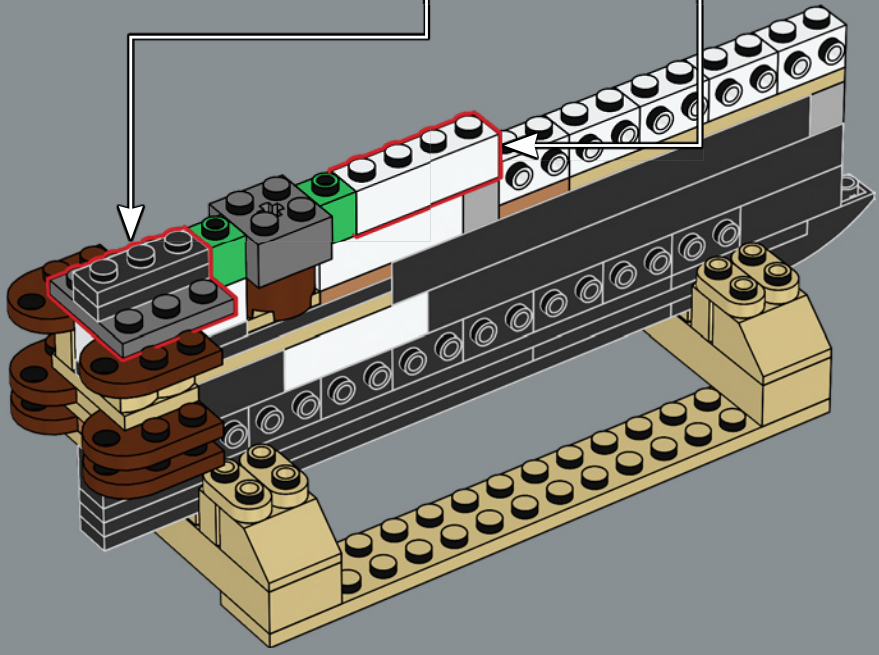
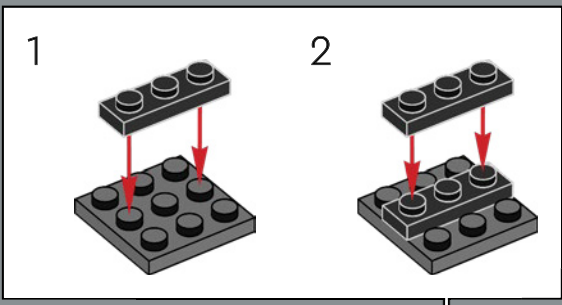

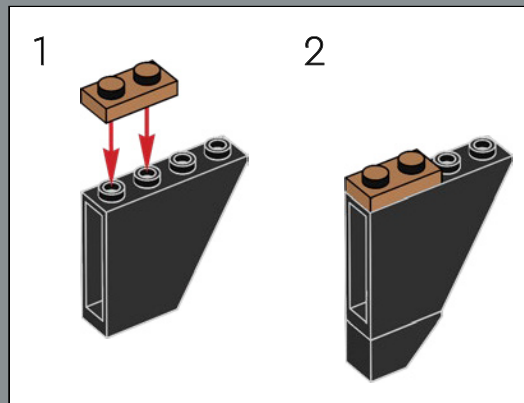
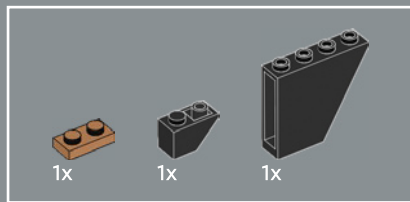

15

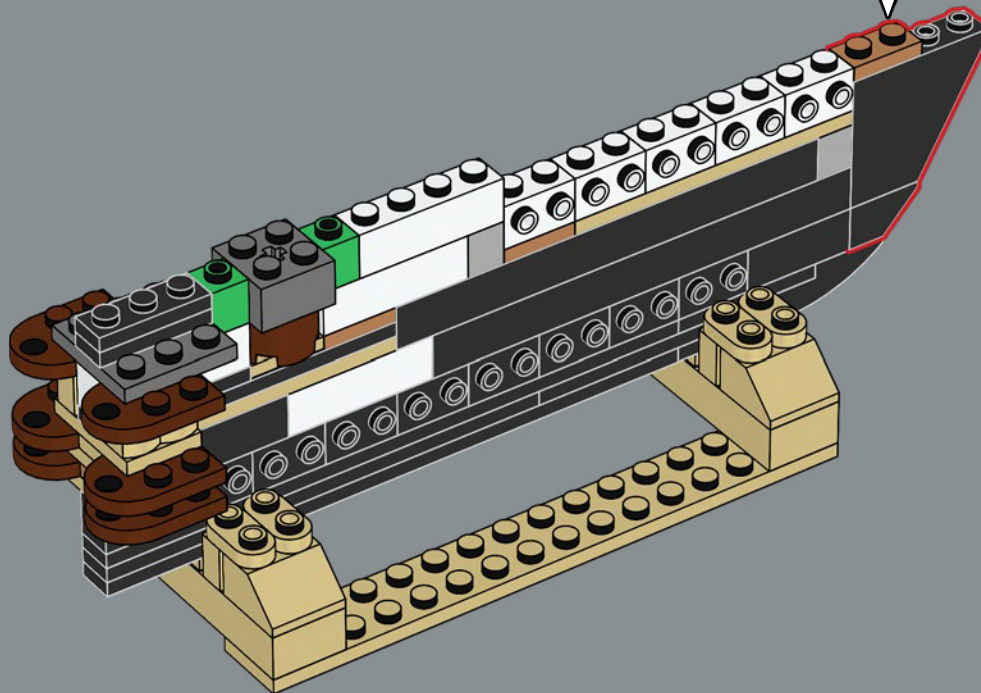

La parte anteriore dello scafo della nave era rivestita con lamiere per proteggere la chiglia di legno dal ghiaccio polare. Sul modello, questa sezione è stata ricreata con un mattoncino "slope" invertito 1x4x3 usato raramente.

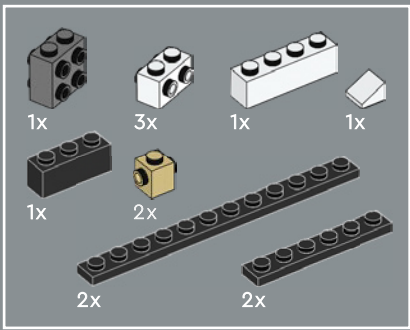

16

1

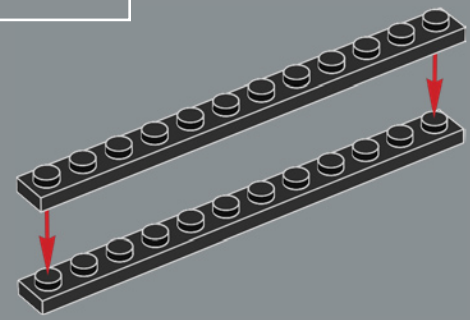

2

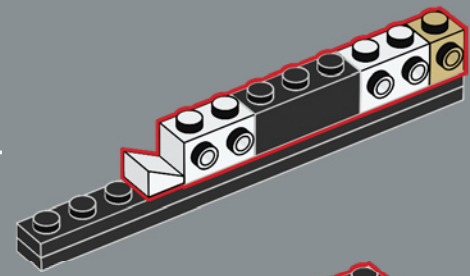

3

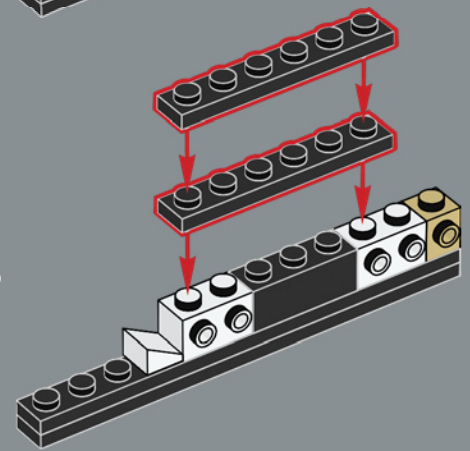

4

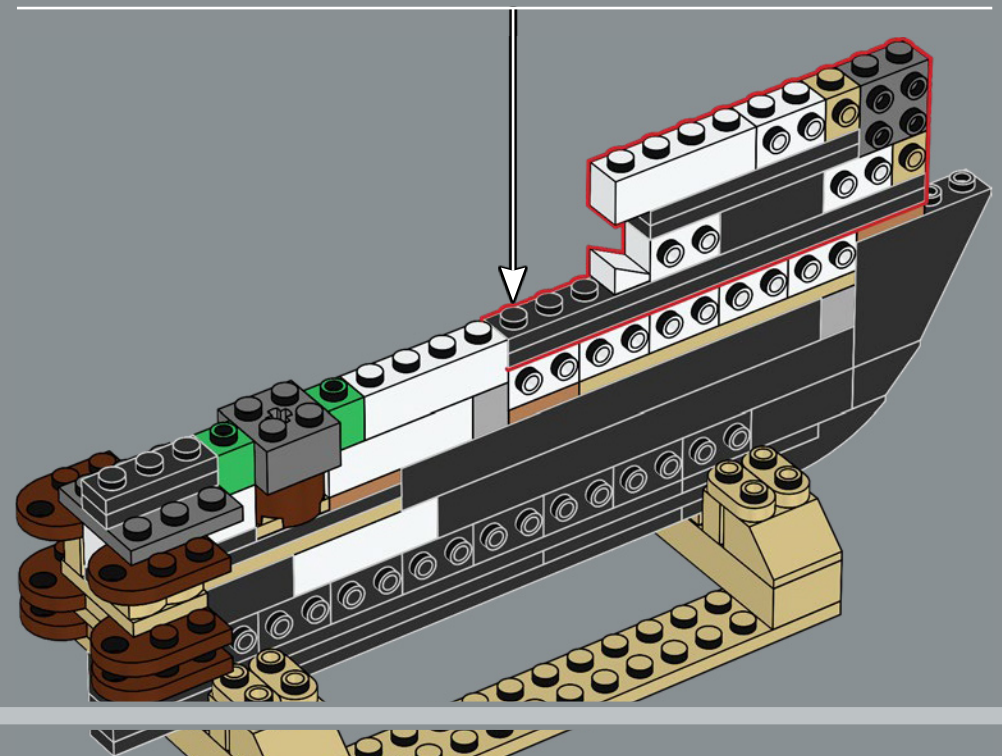
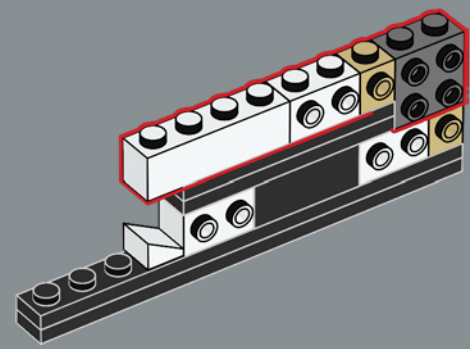

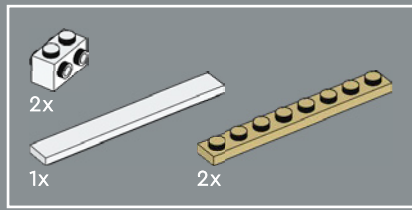

17

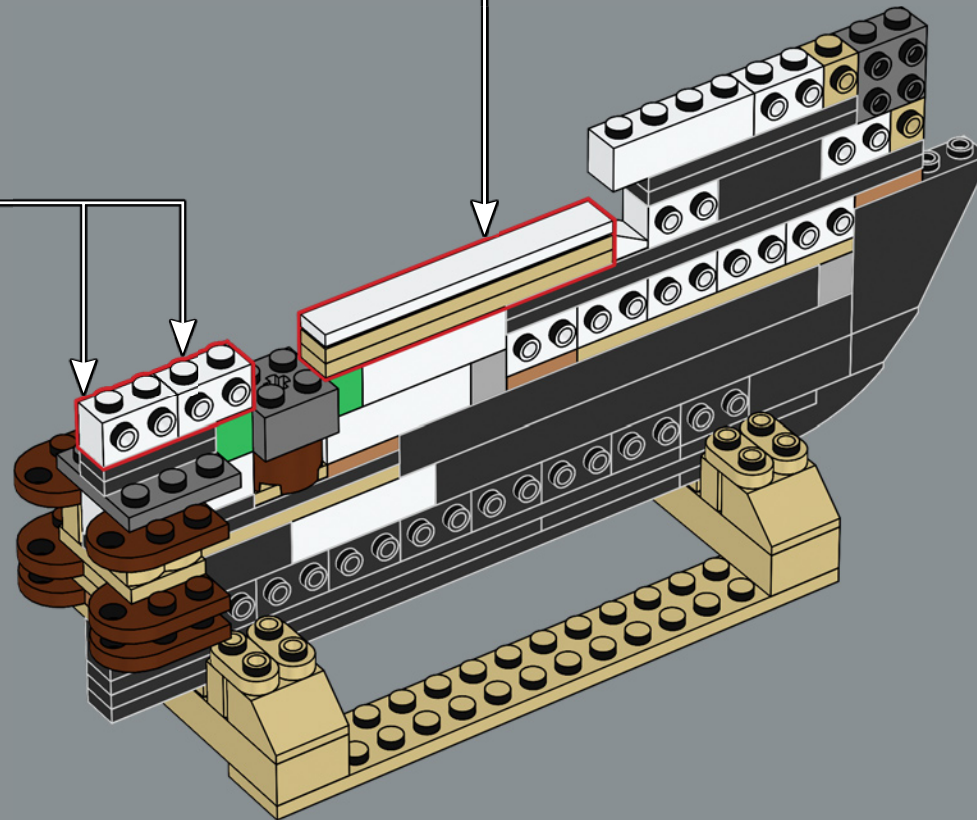
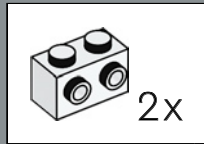
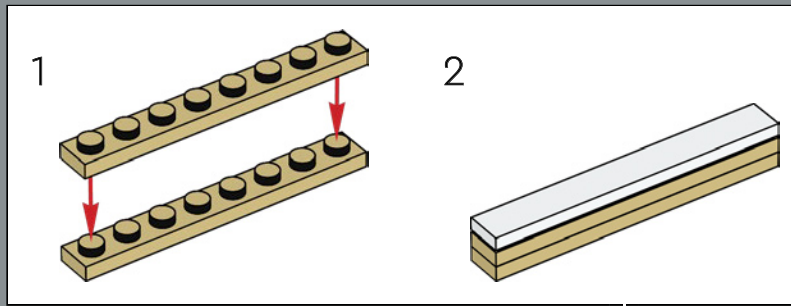

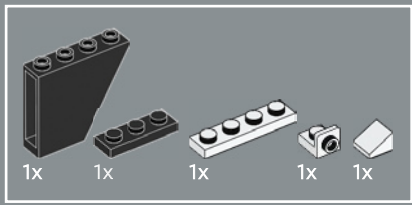

18

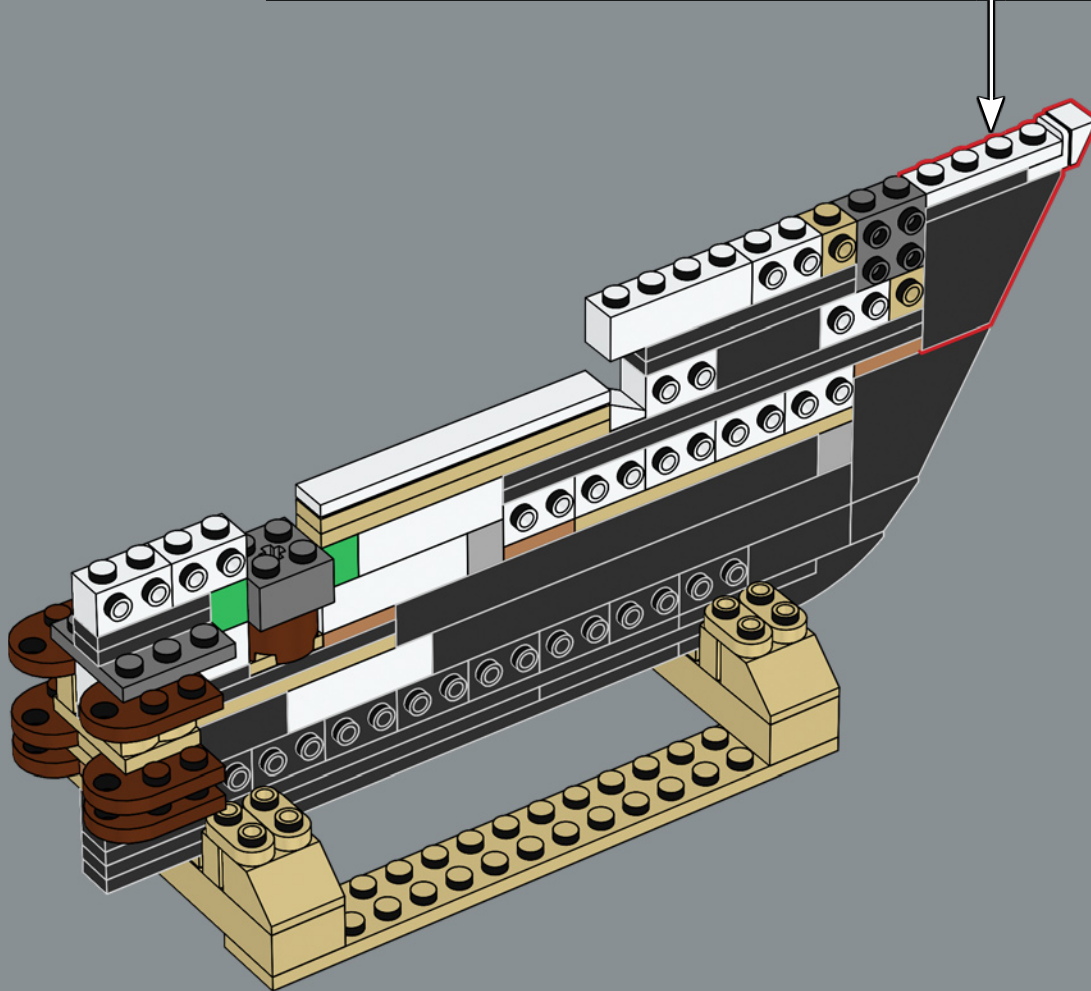
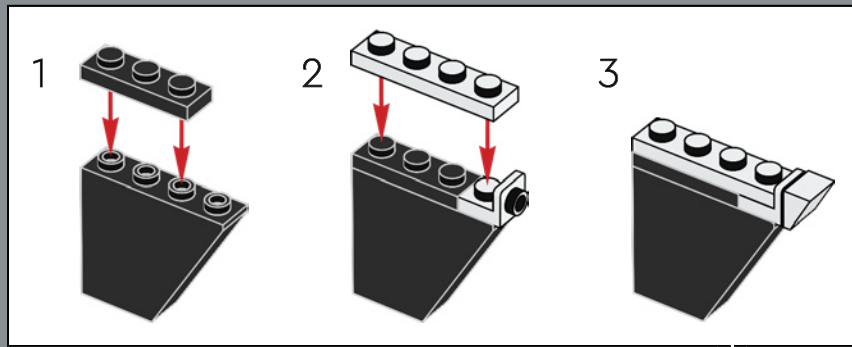

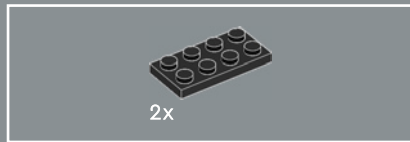
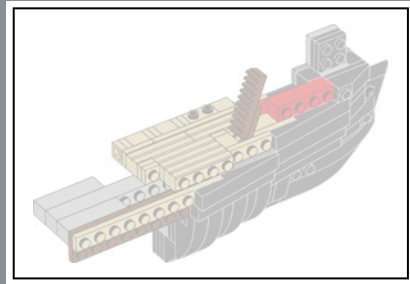

19

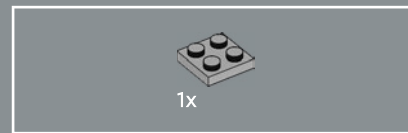
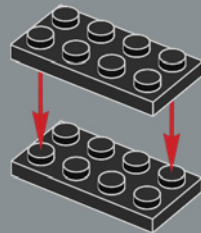

20

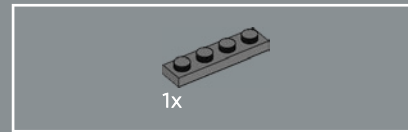
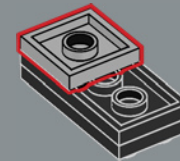

21

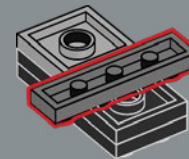

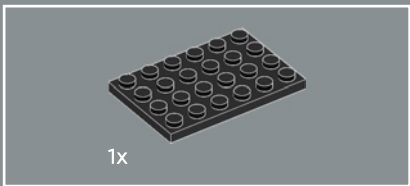

22

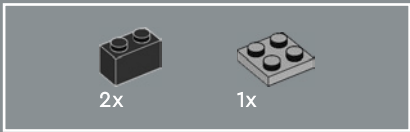
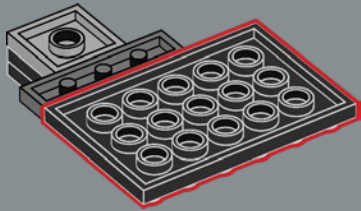

23

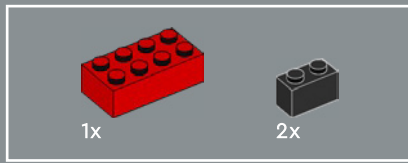
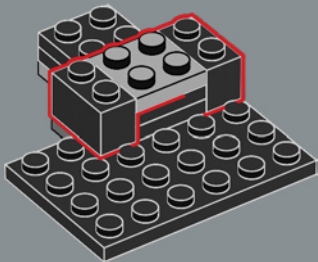

24

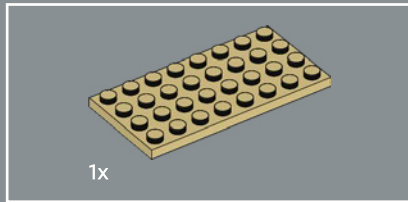
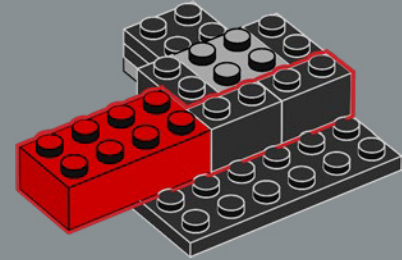

25

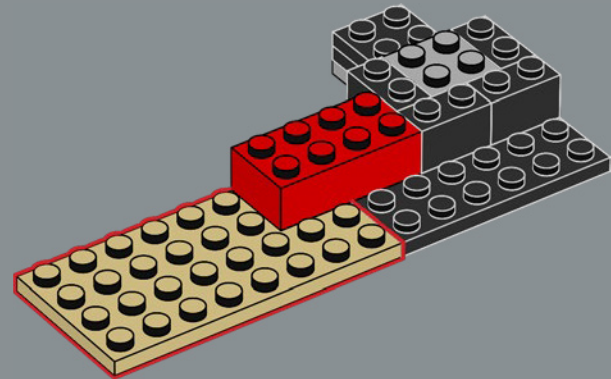

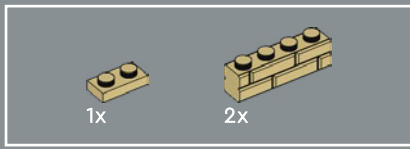

26

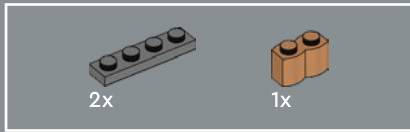
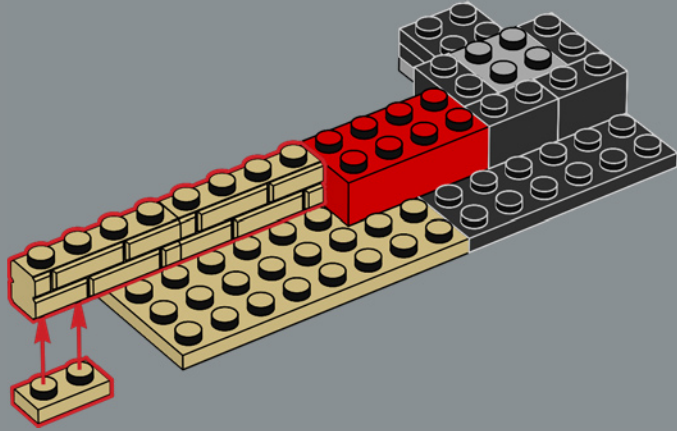

27

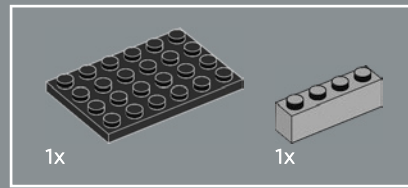
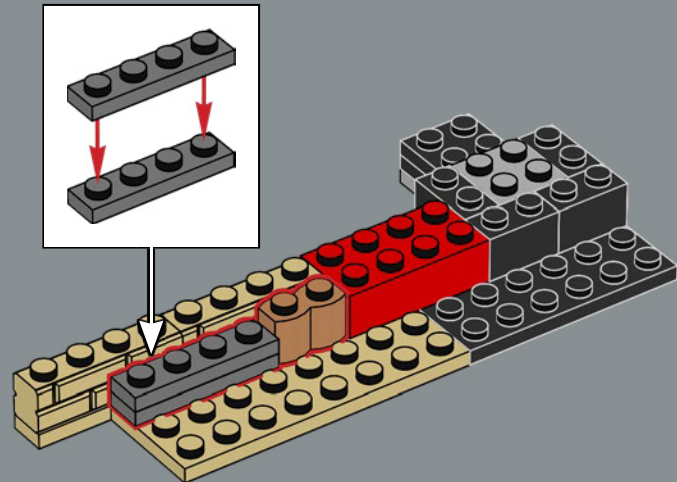

28

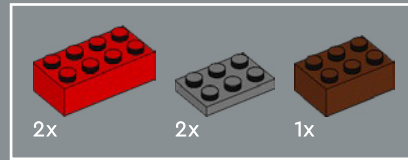
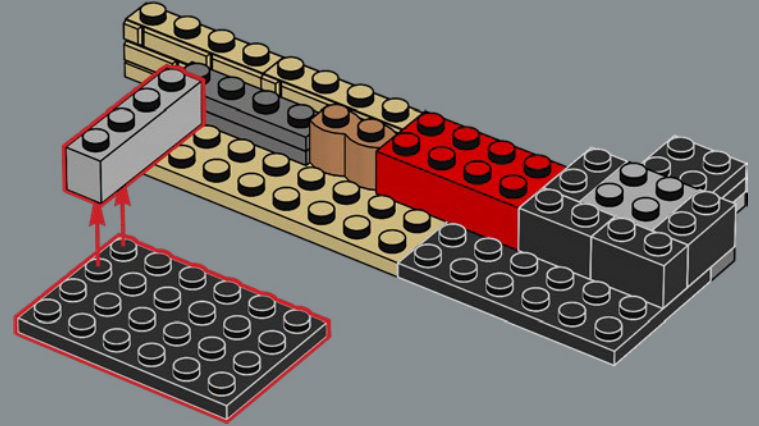

29

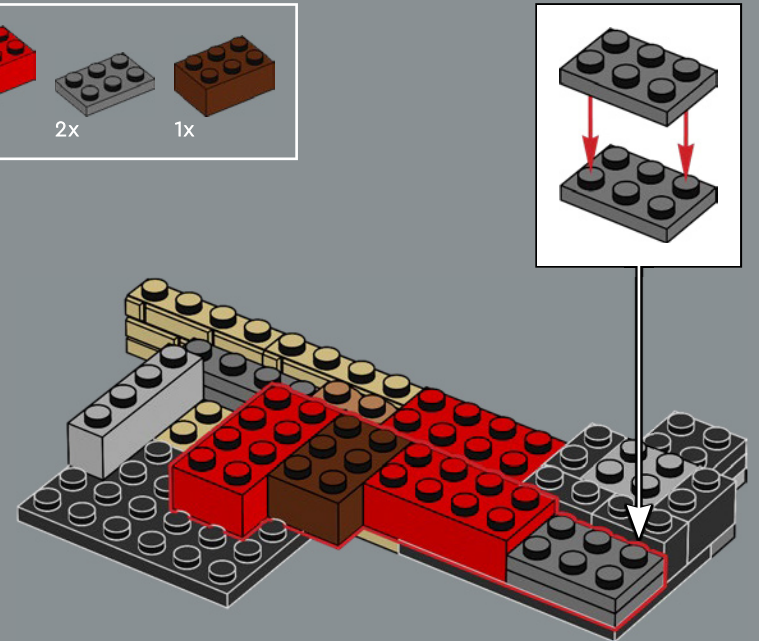

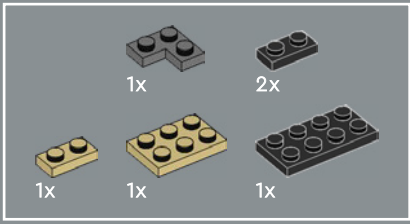

30

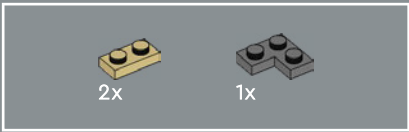
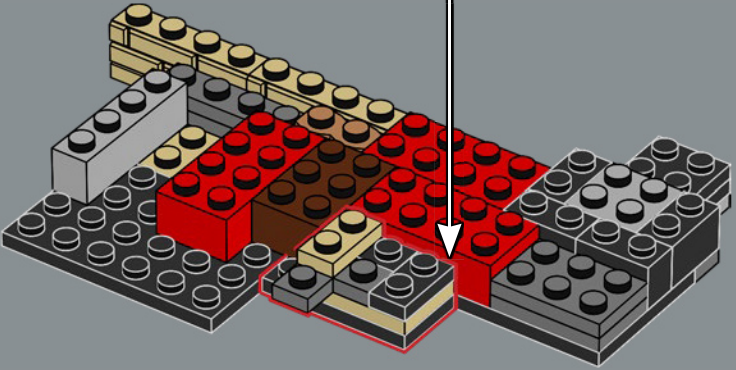
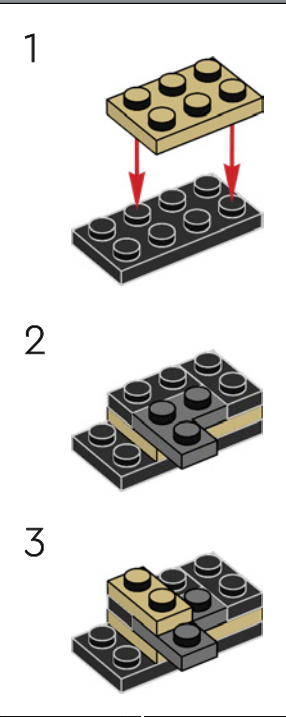

31

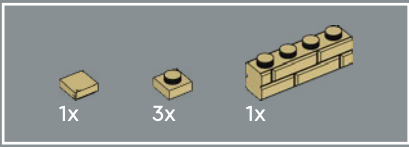
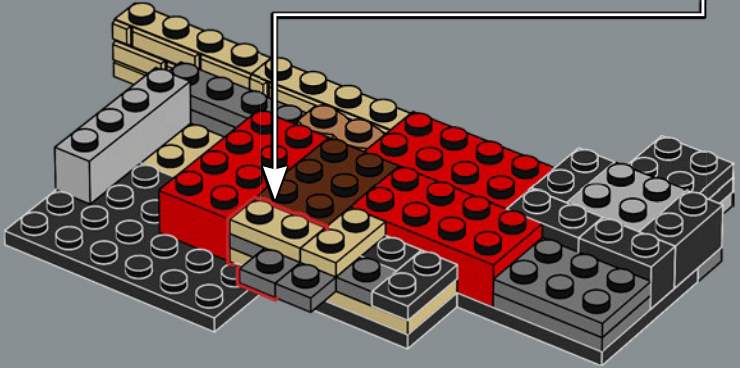
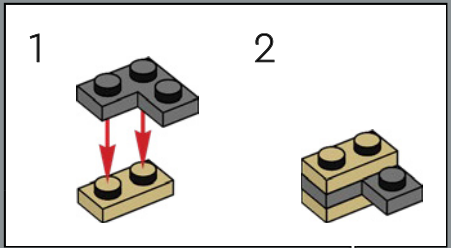

32

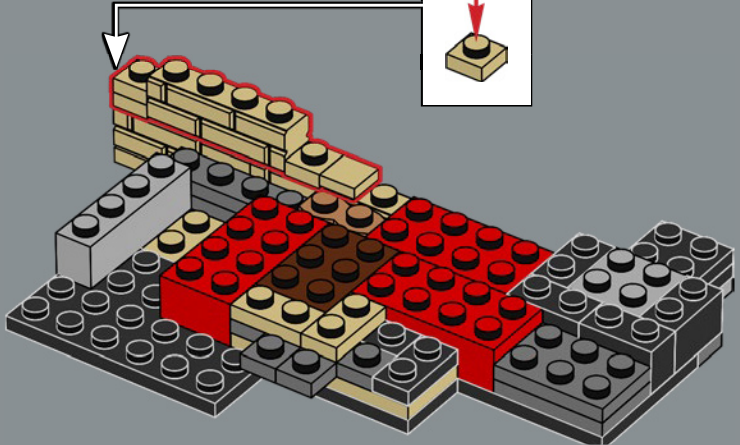
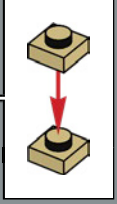



33

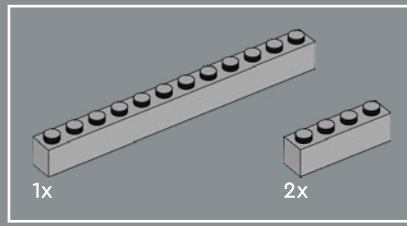
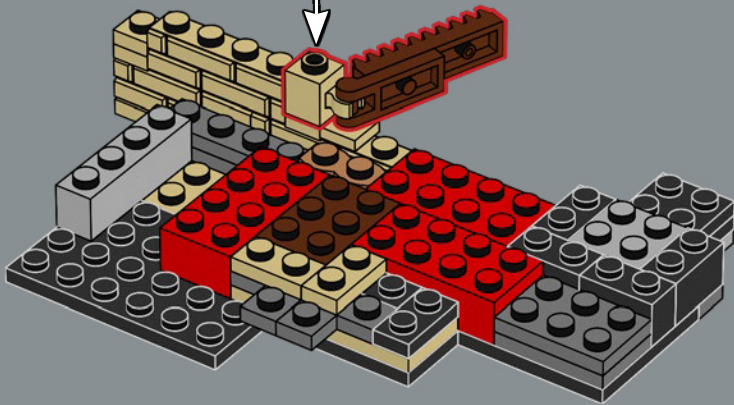
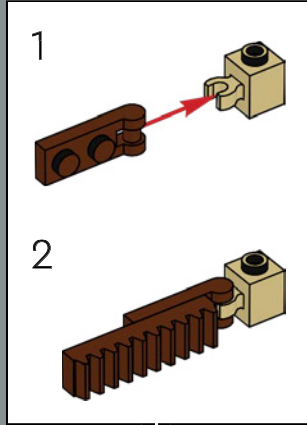

34

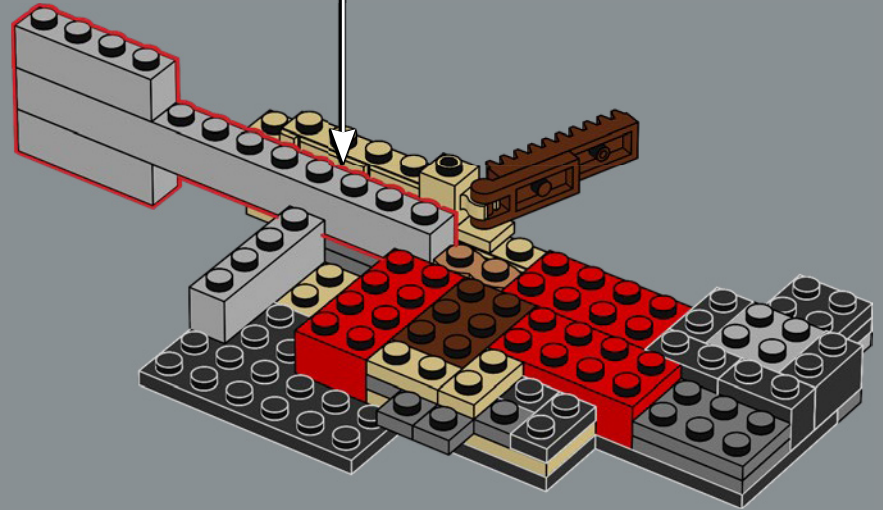
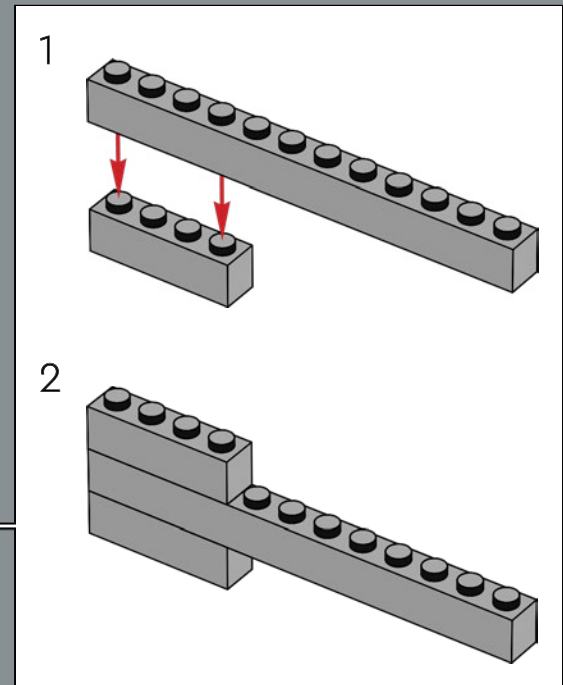

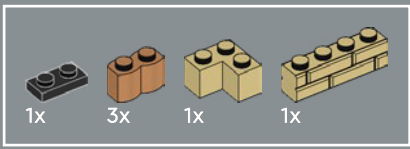

35

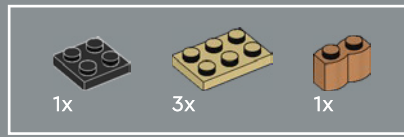
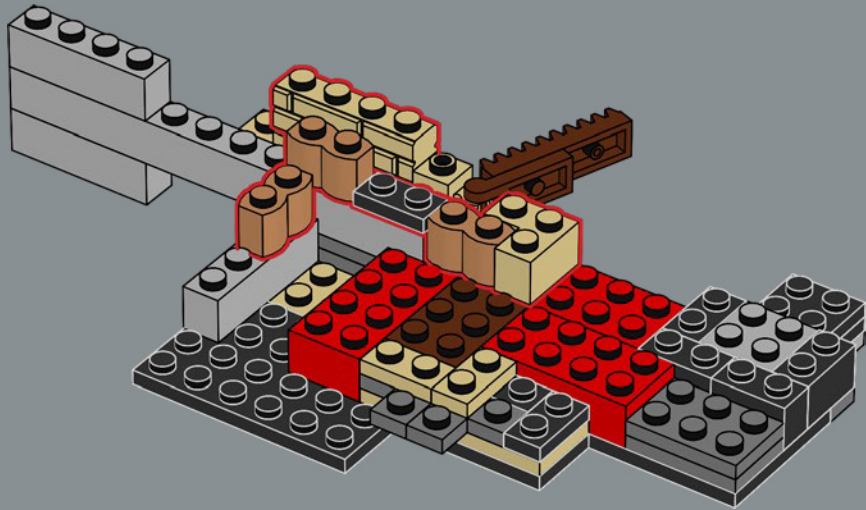

36

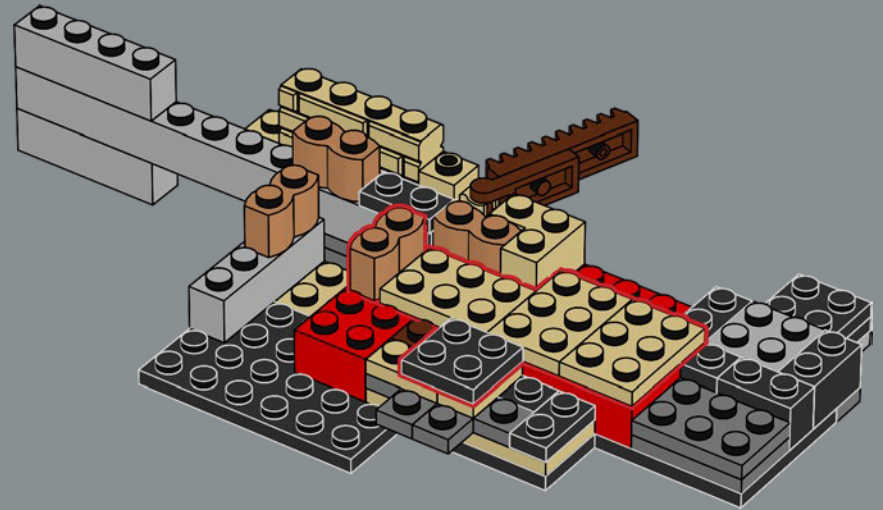

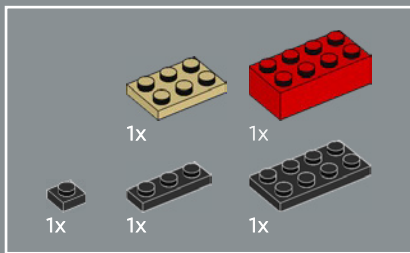

37

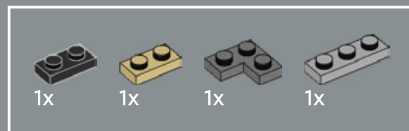
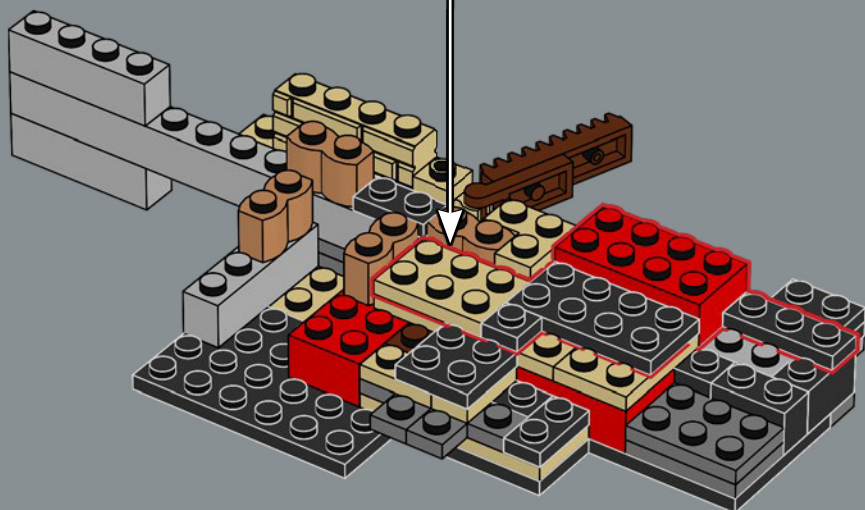
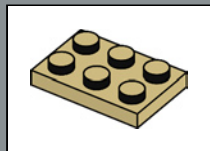

38

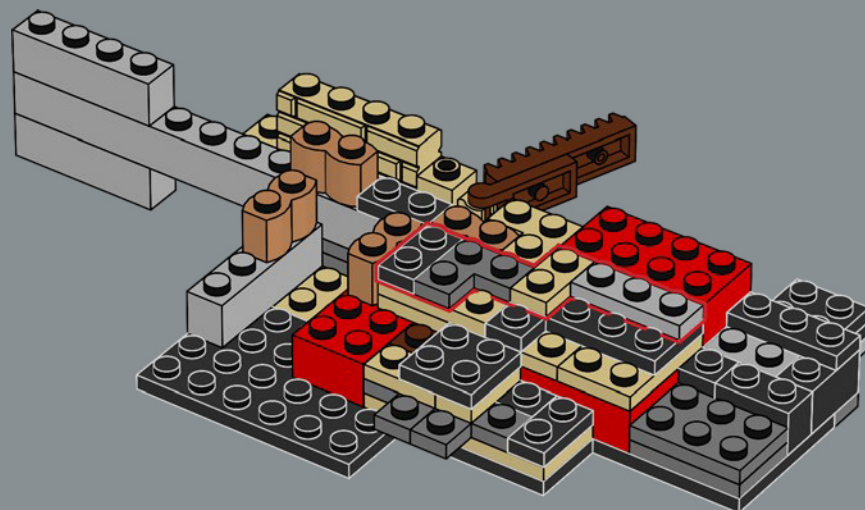

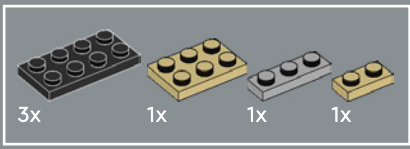

39

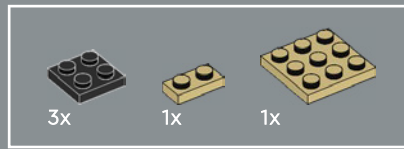
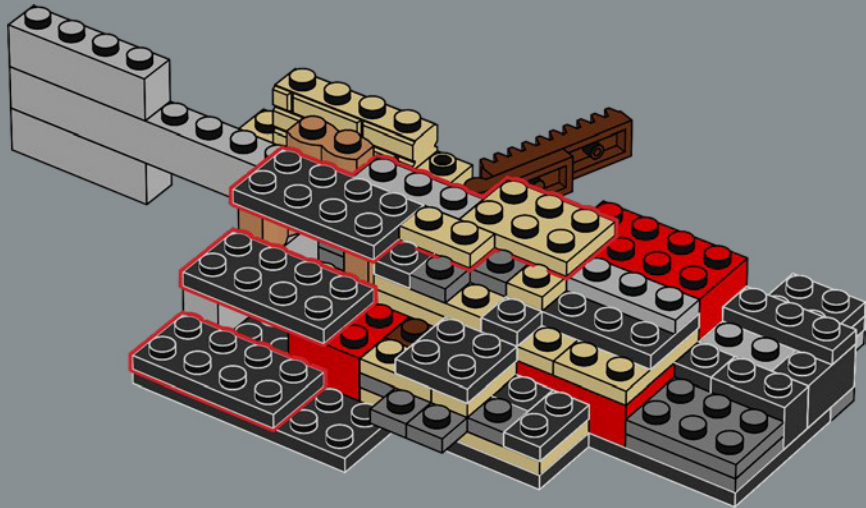

40

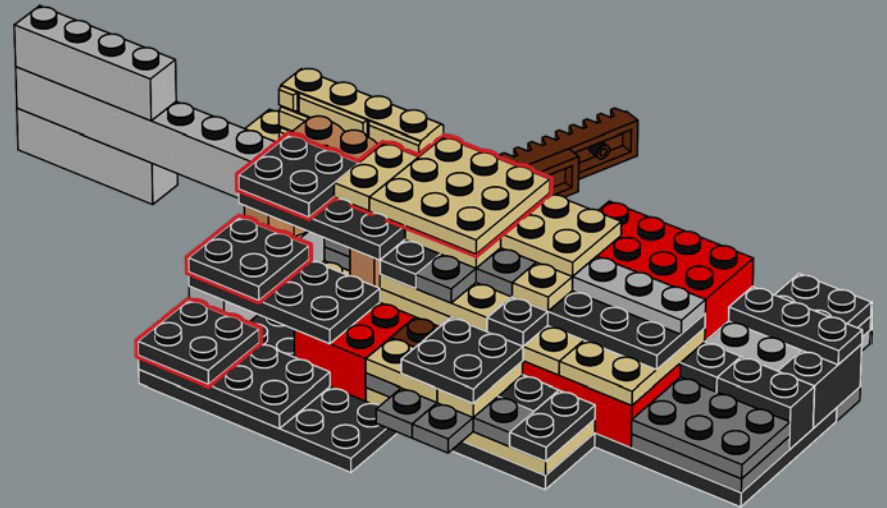

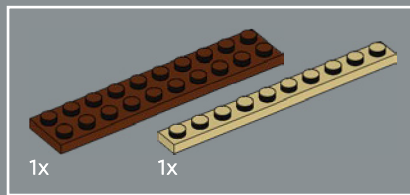

41

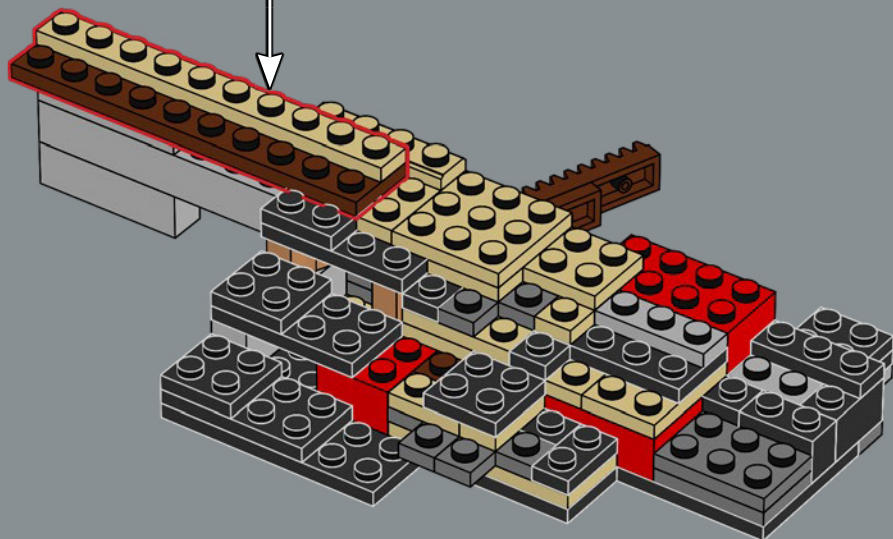
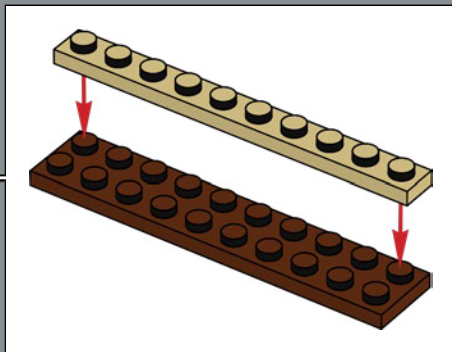

42

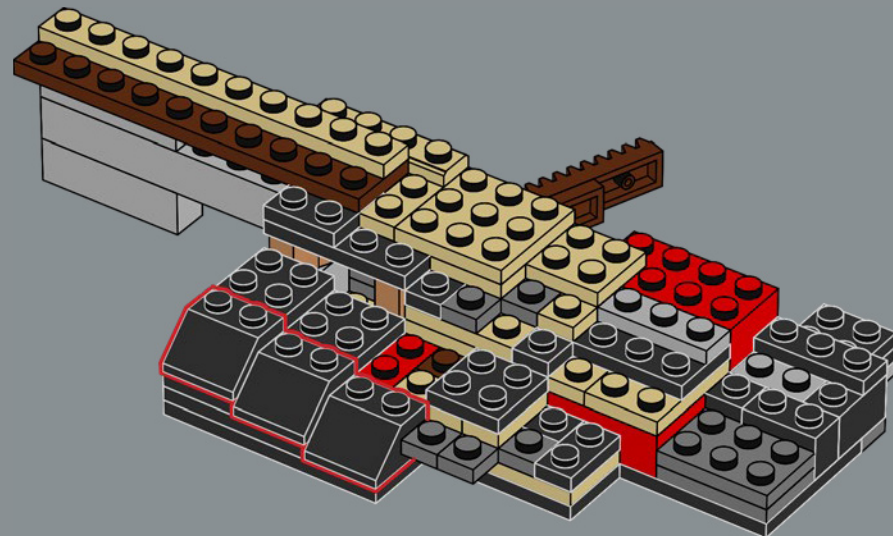



43

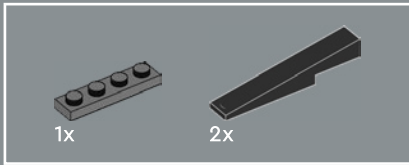
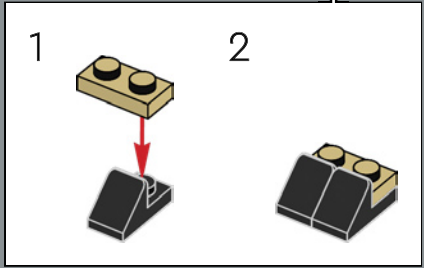
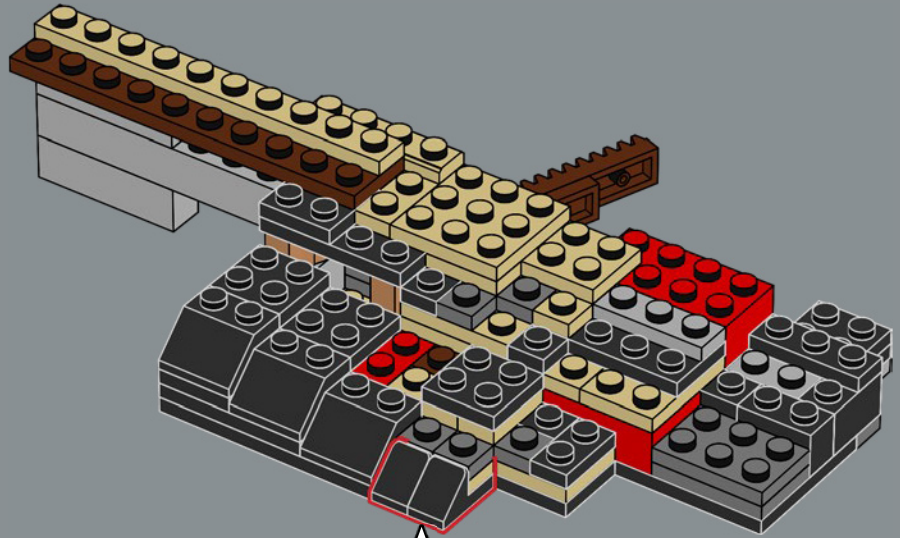

44

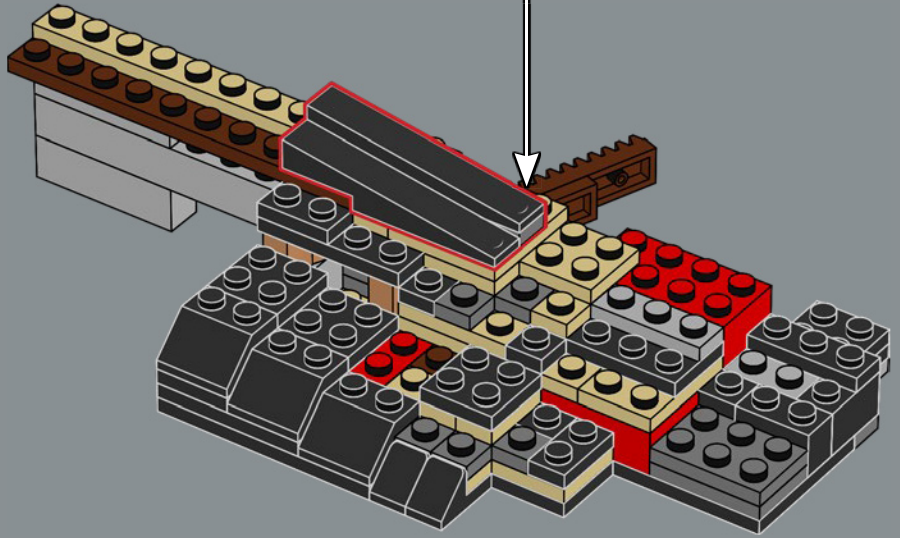
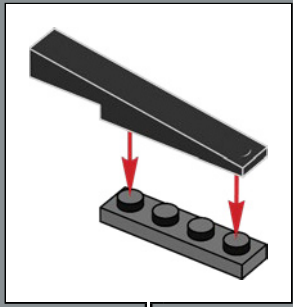



45

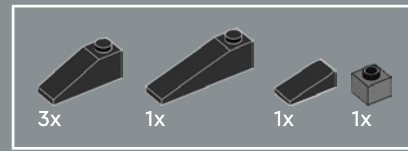
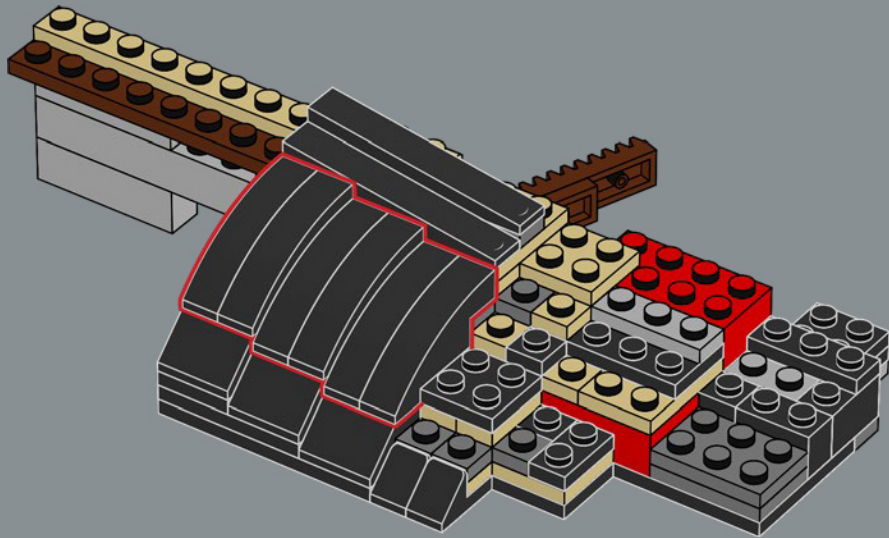

46

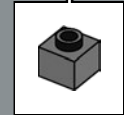
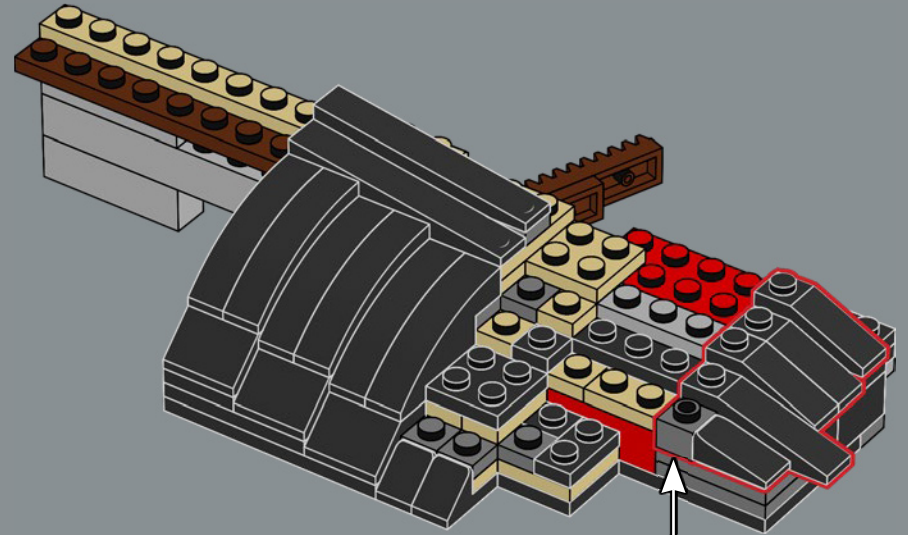

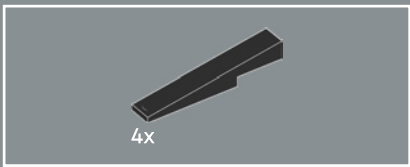

47

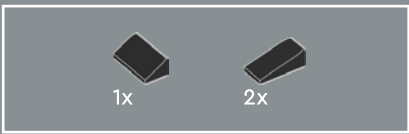
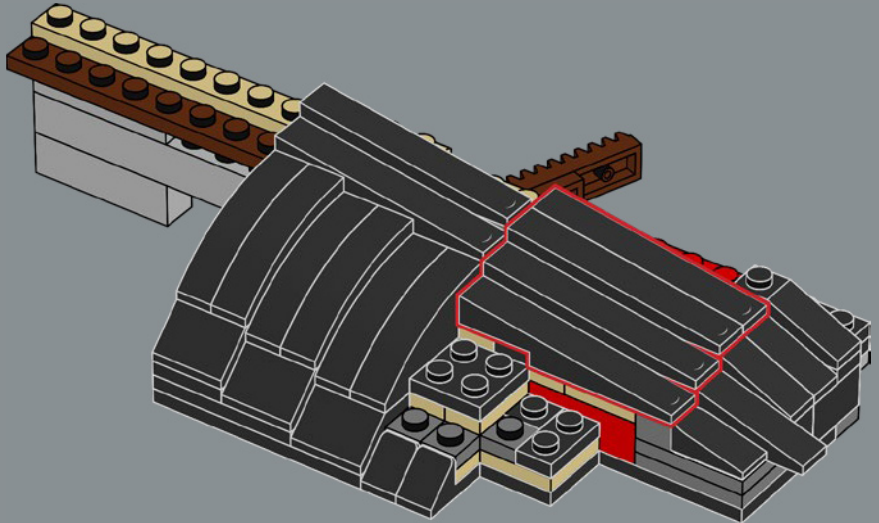

48

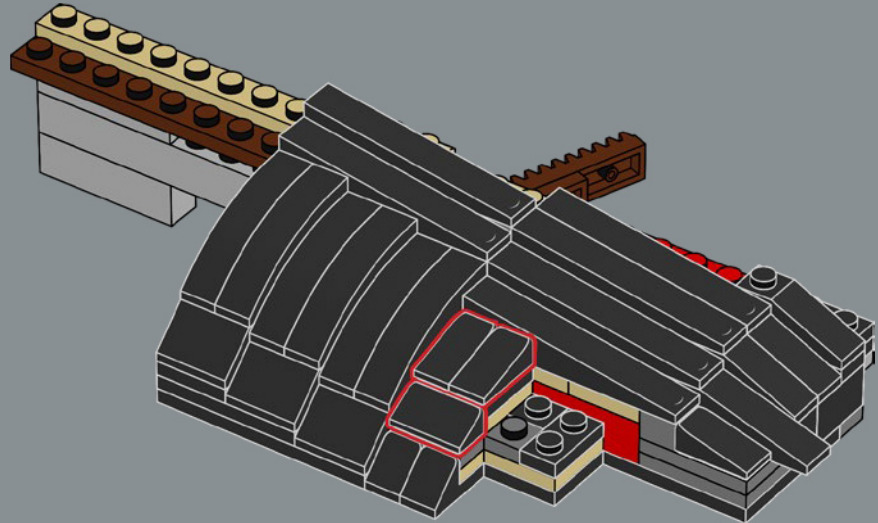

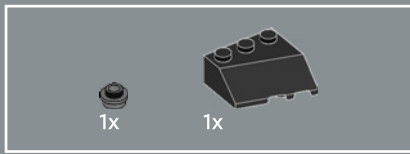

49

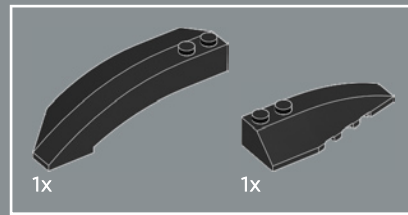
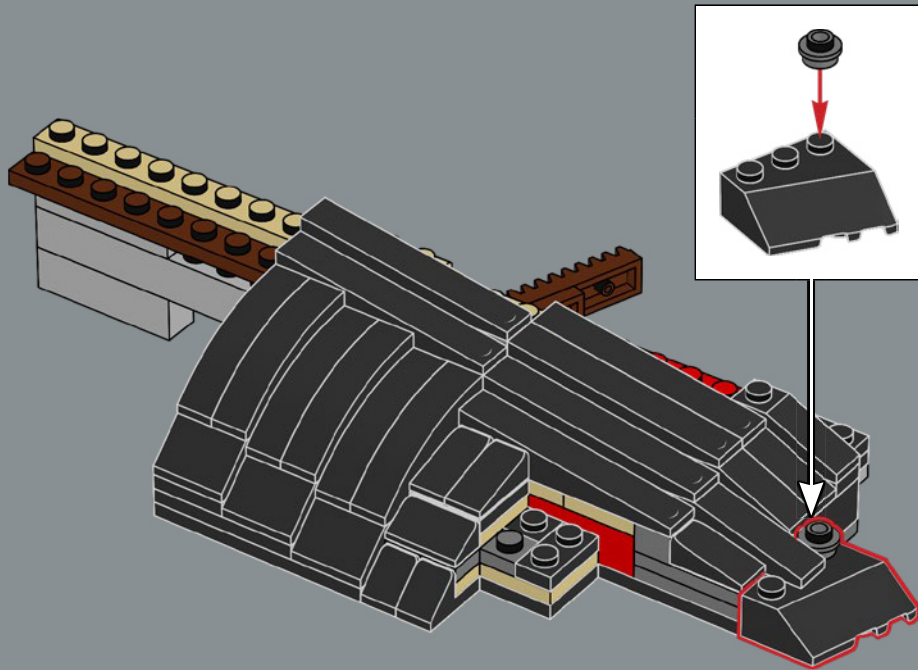

50

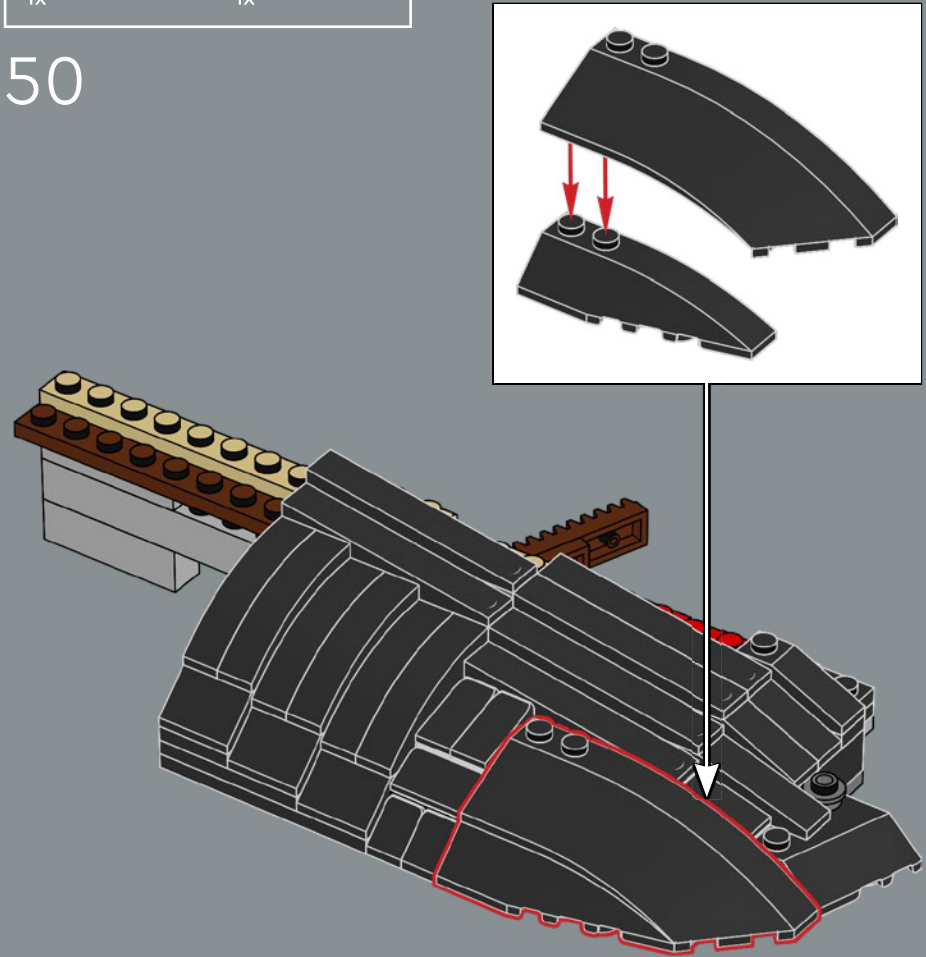



51

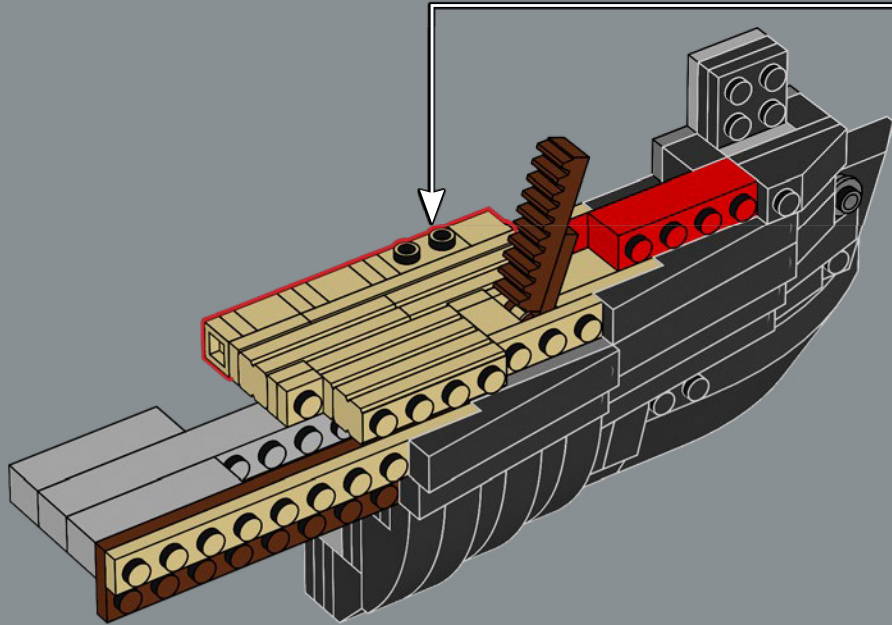
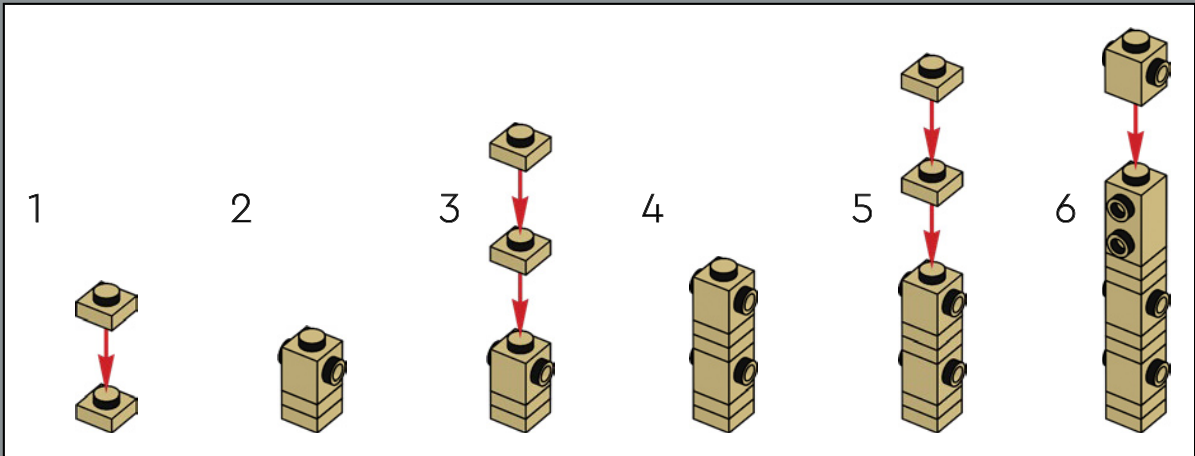

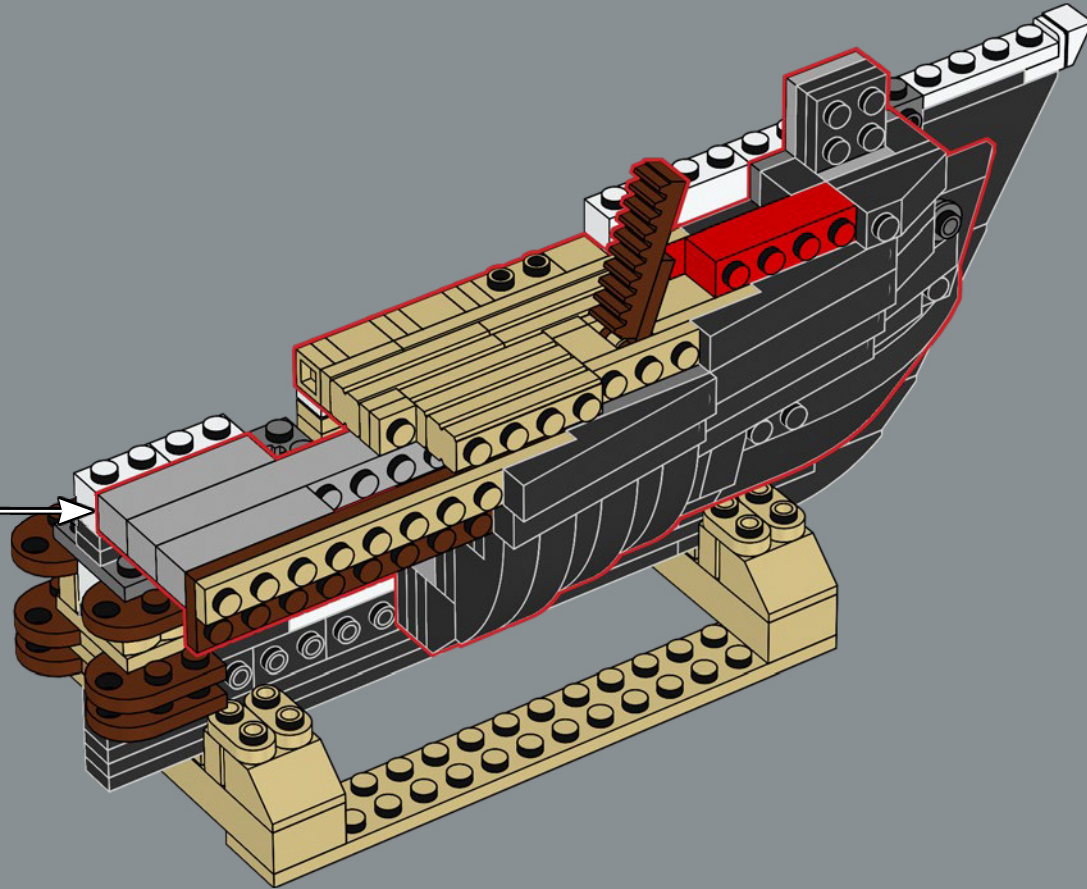

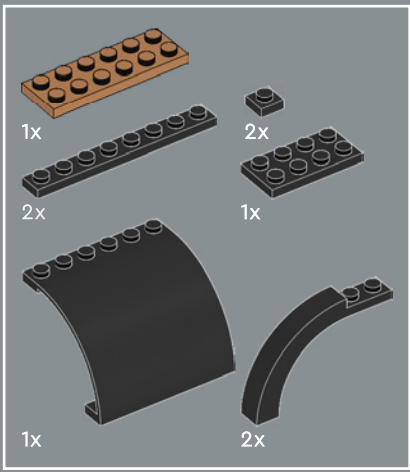

53

1

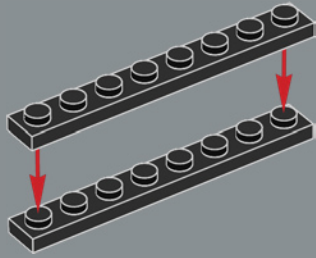

2

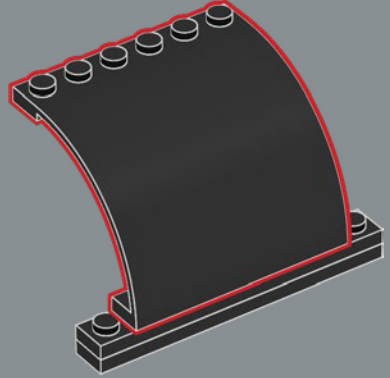

3

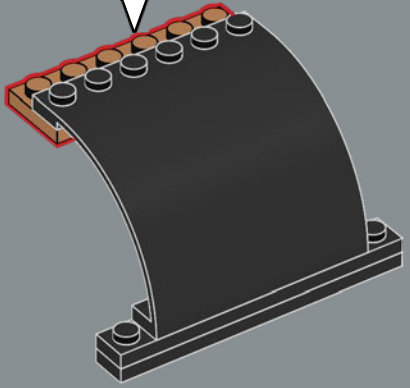
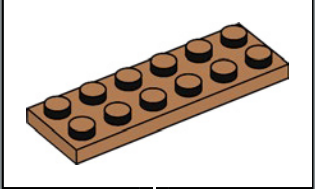

4

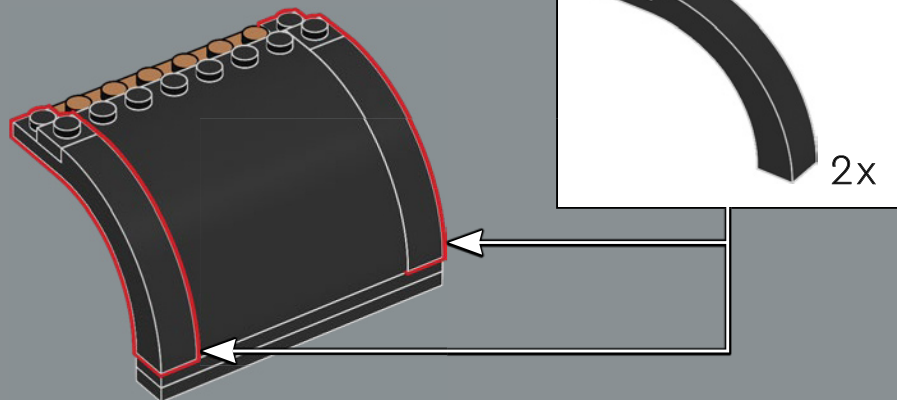

5

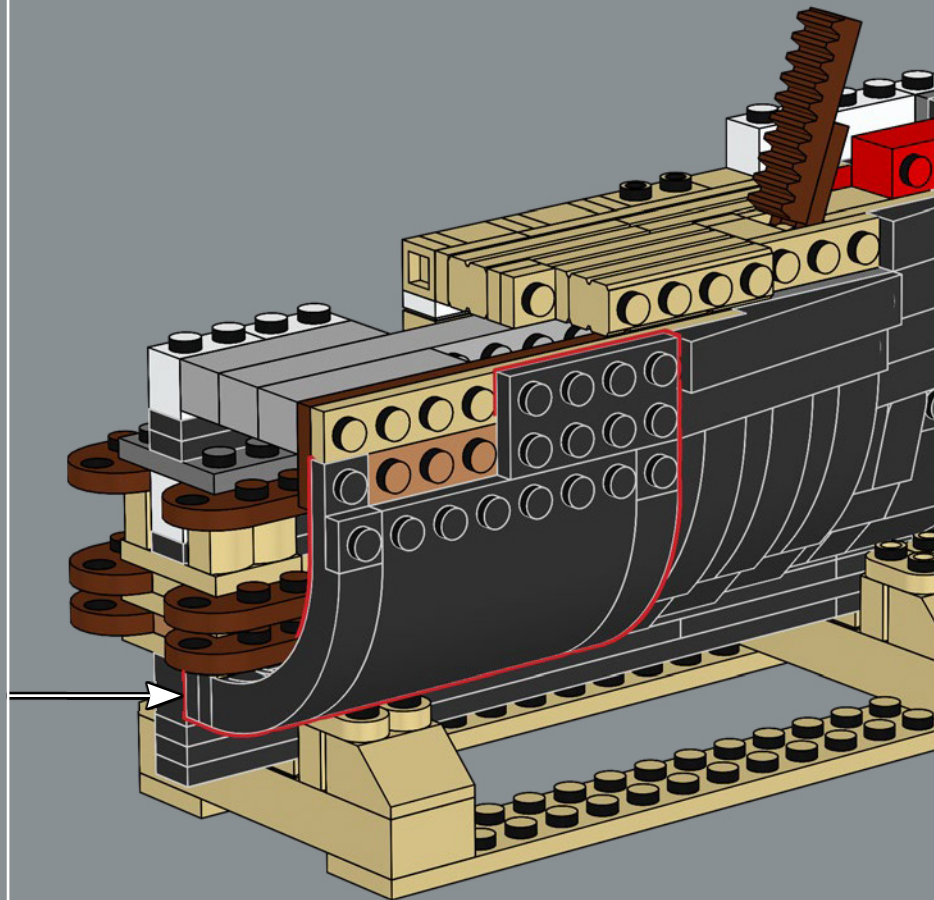
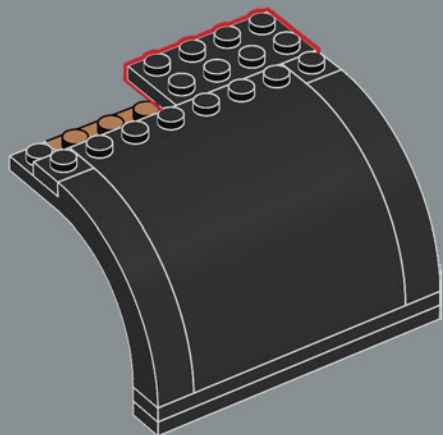

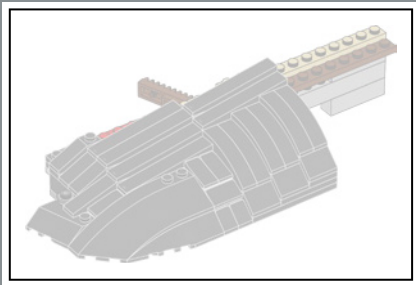

54

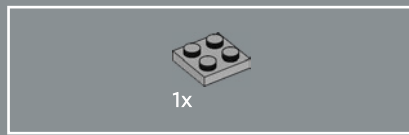
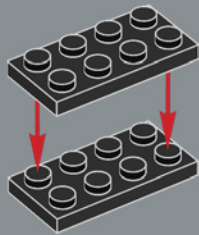

55

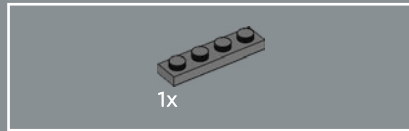
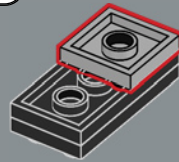

56

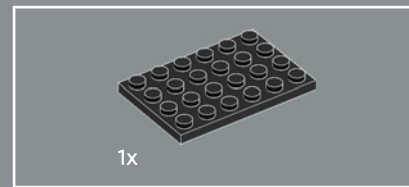
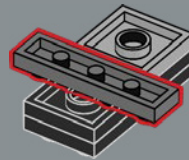

57

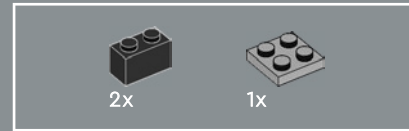
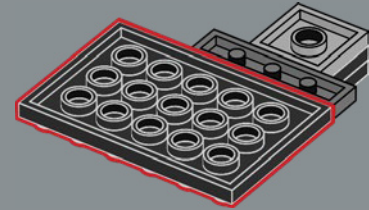

58

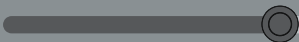
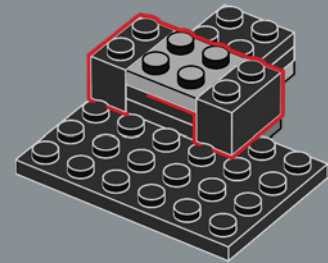

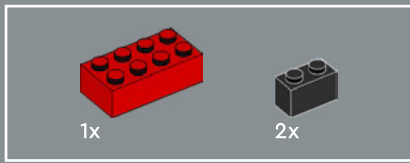

59

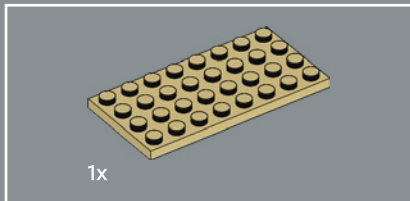
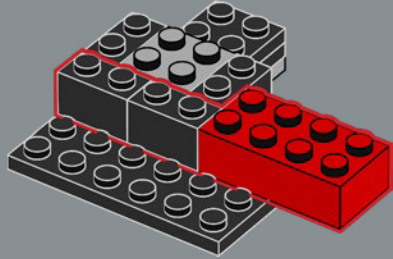

60

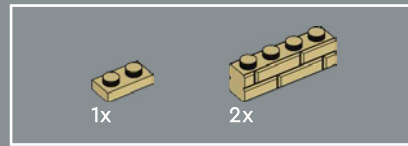
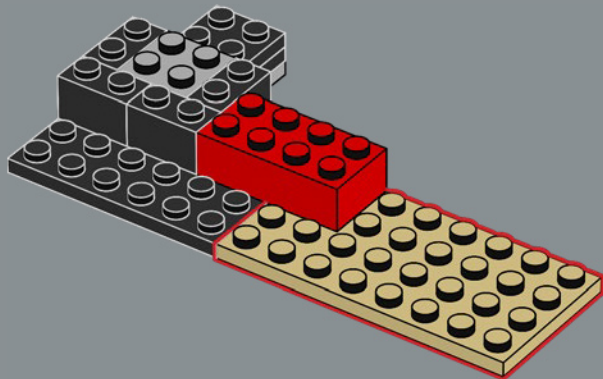

61

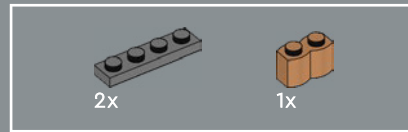
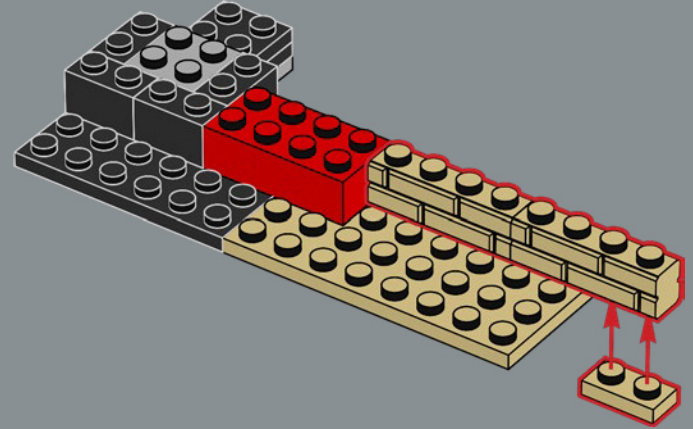

62

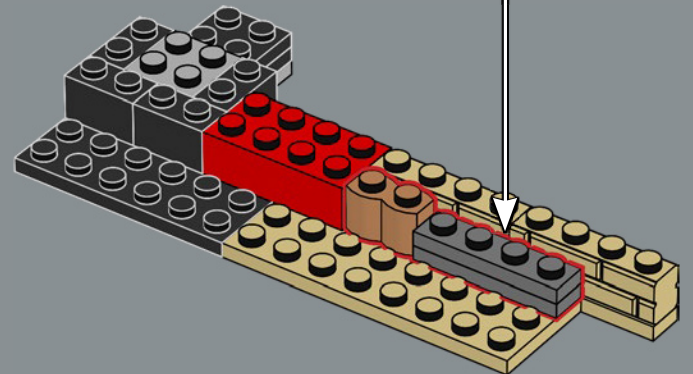
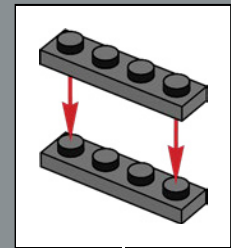

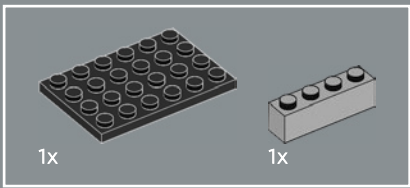

63

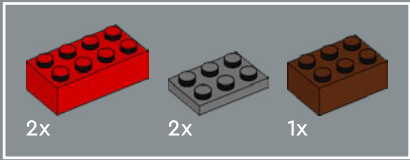
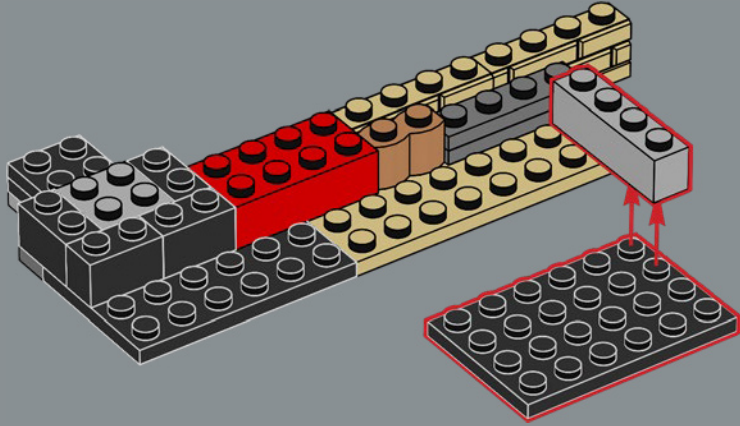

64

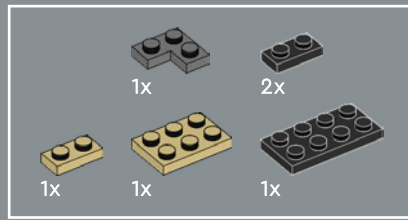
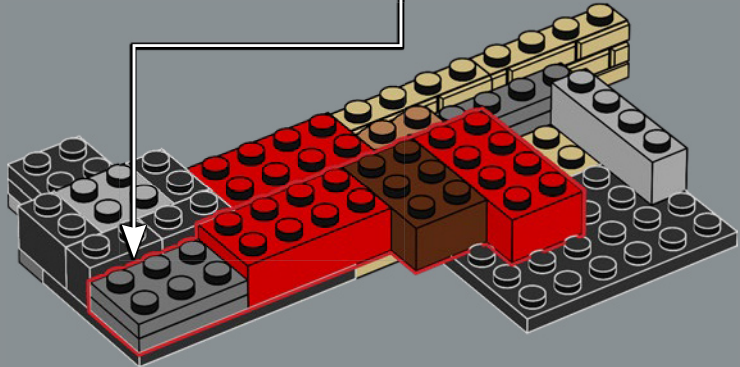
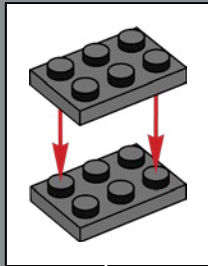

65

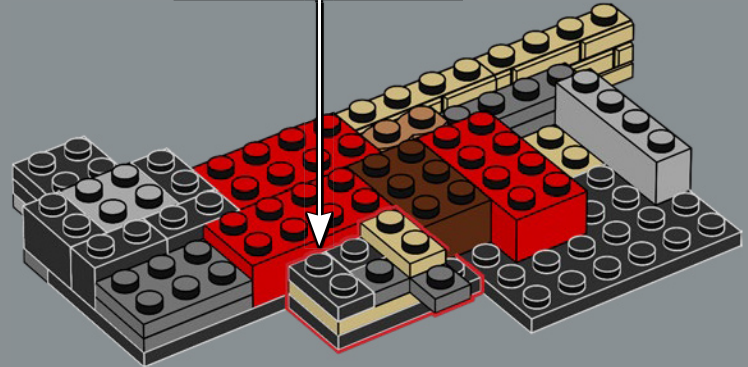
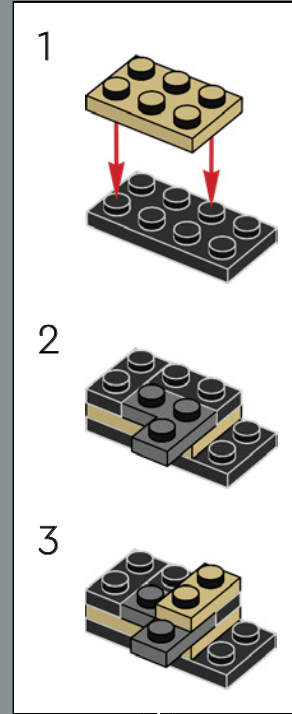

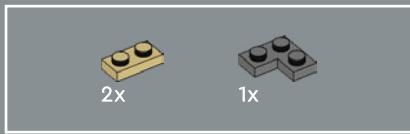

66

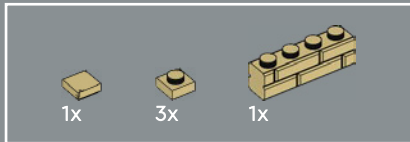
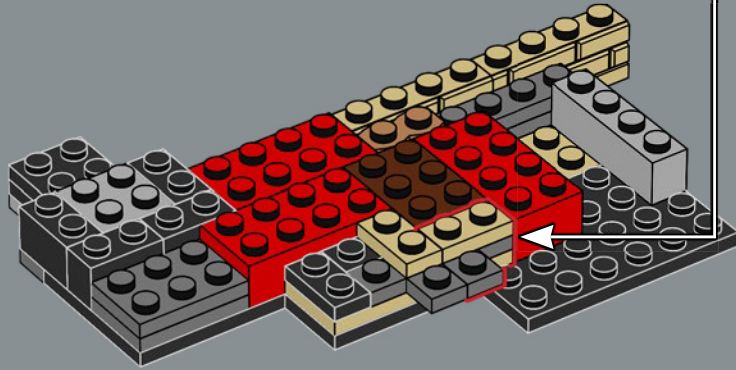
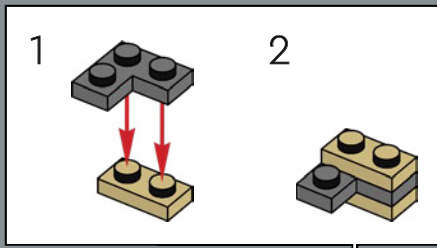

67

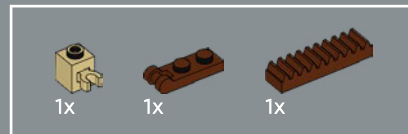
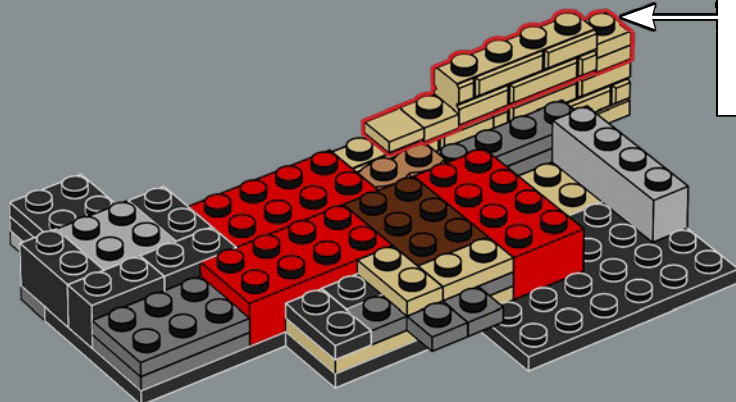
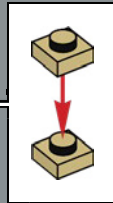

68

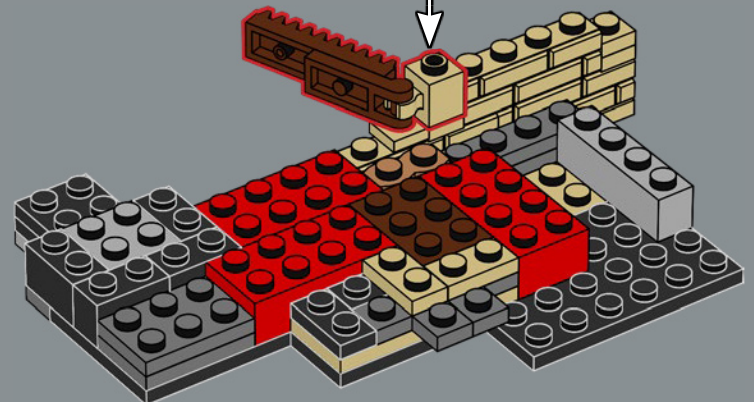
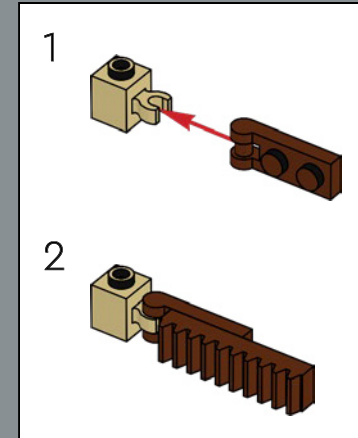

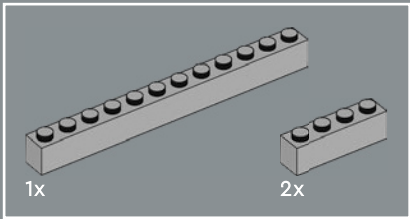

69

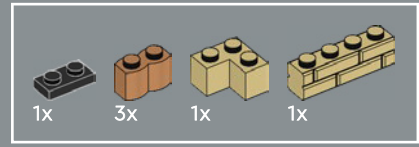
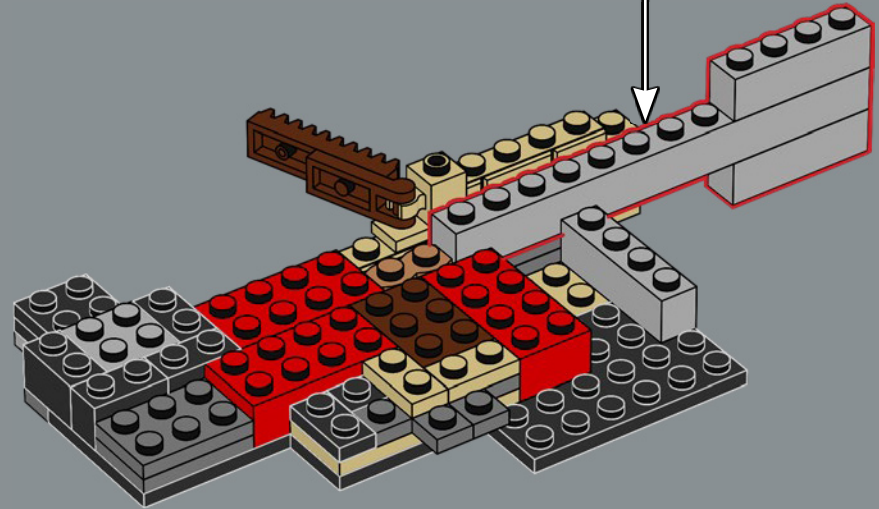
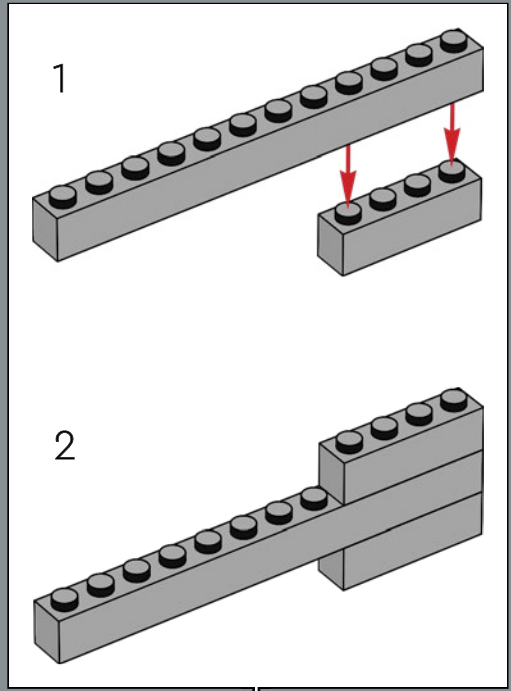

70

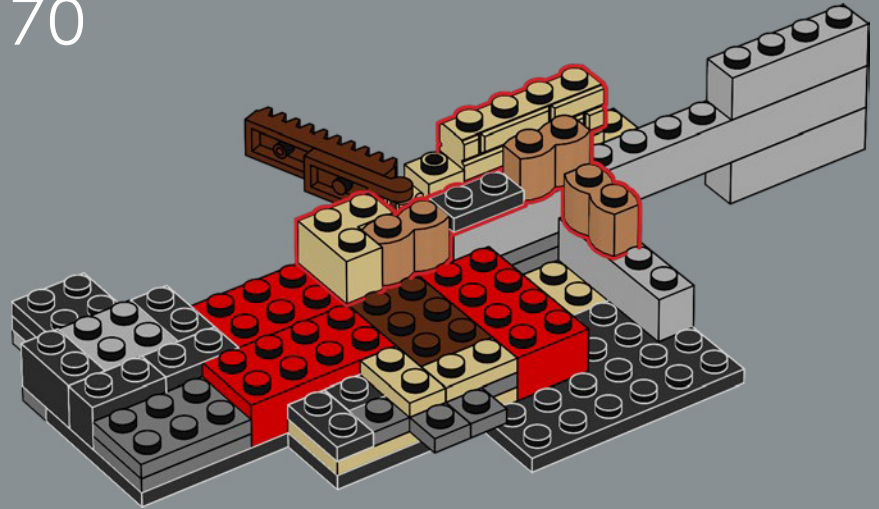

71

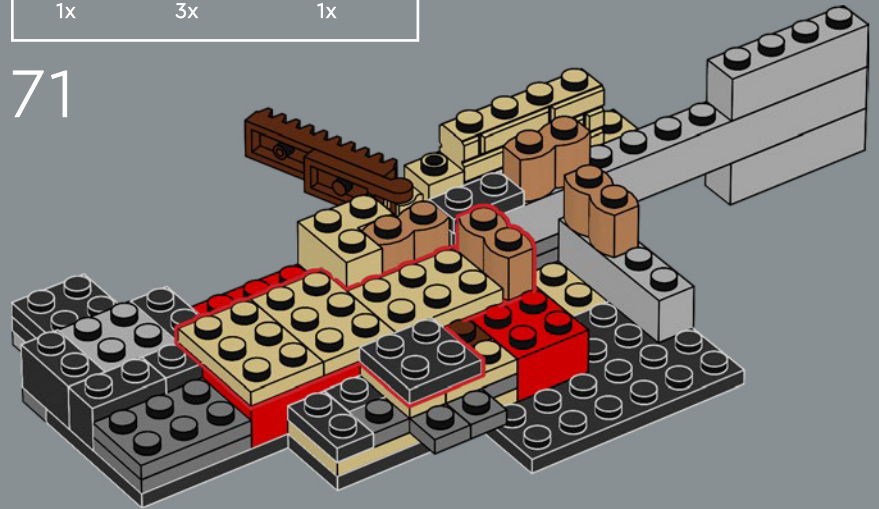

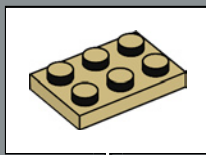
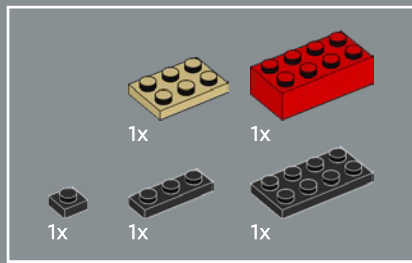

72

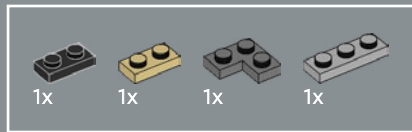
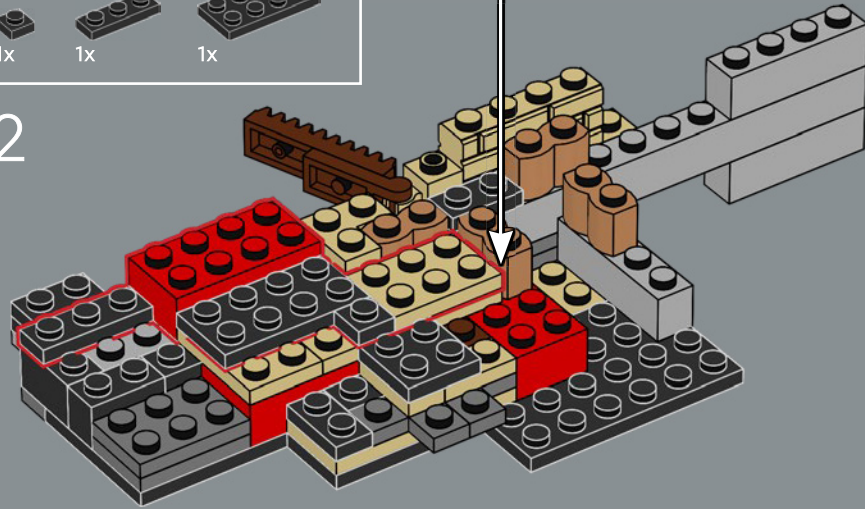

73

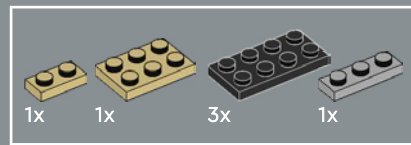
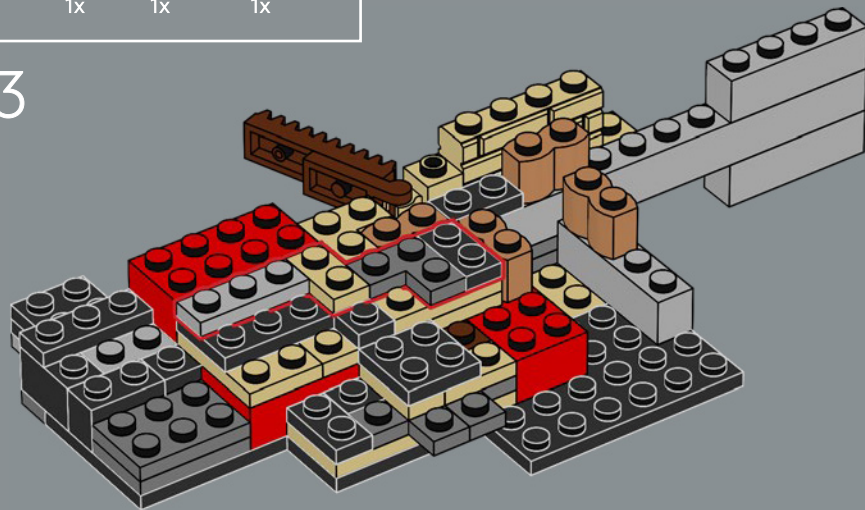

74

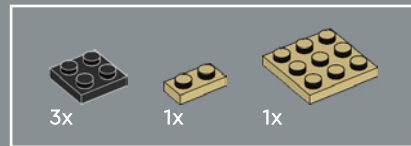
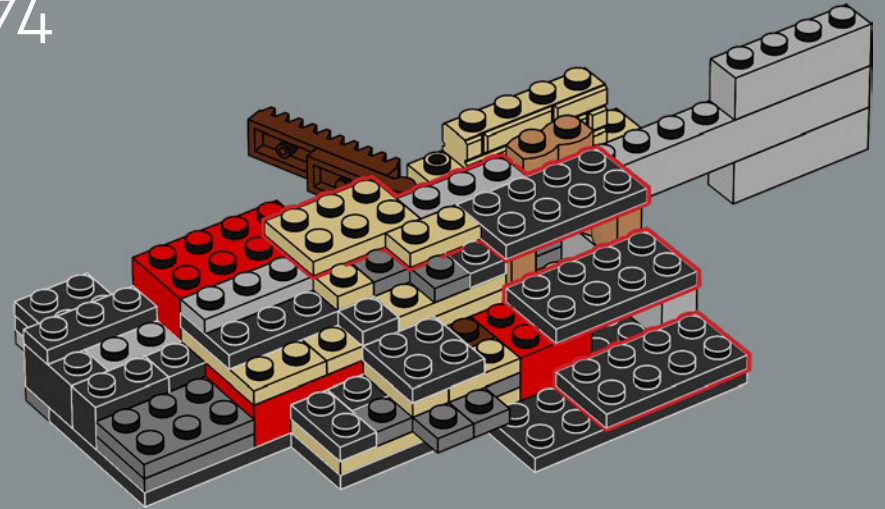

75

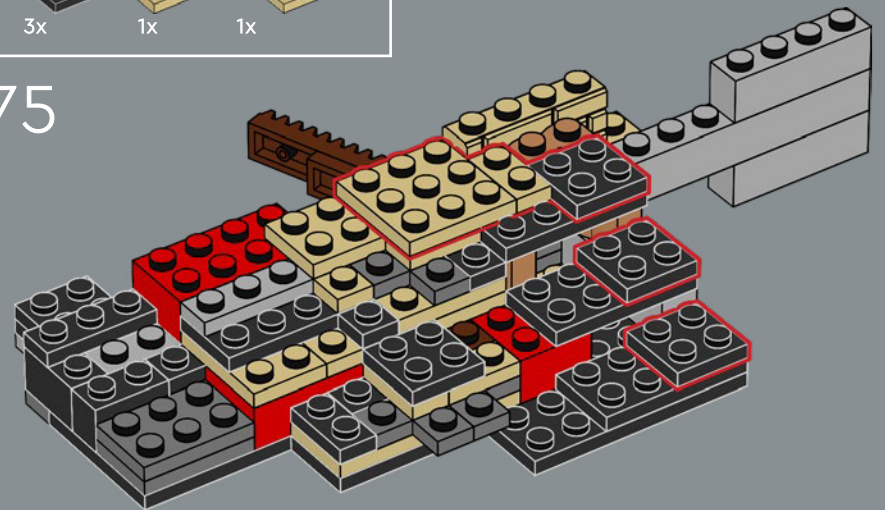

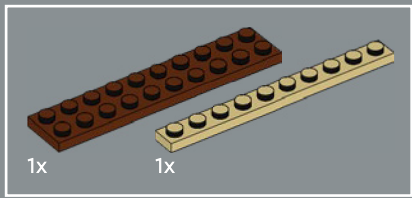

76

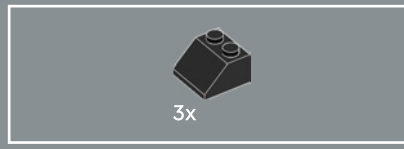
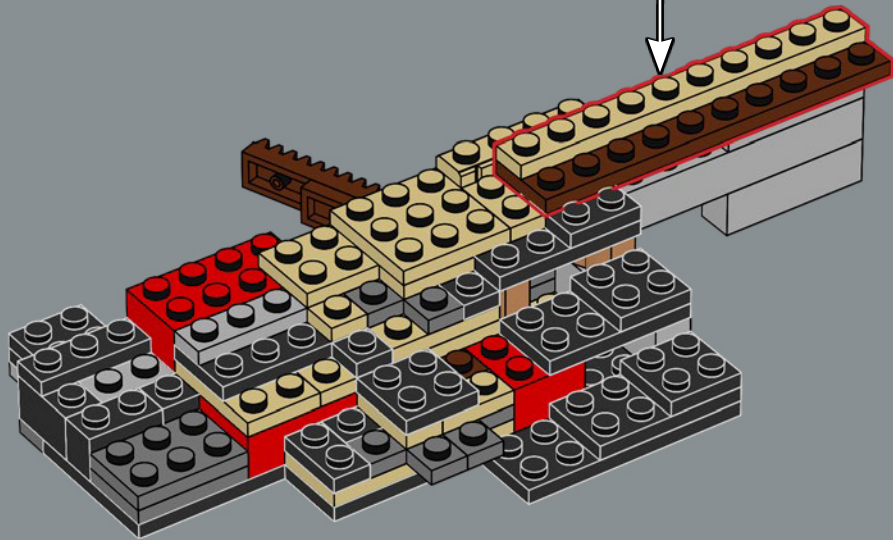
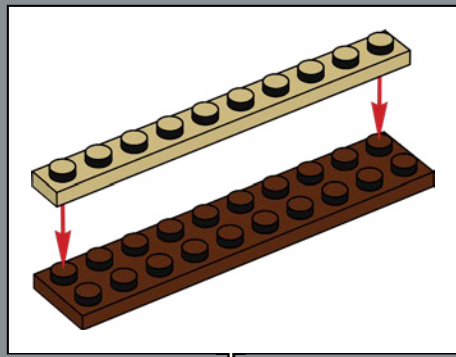

77

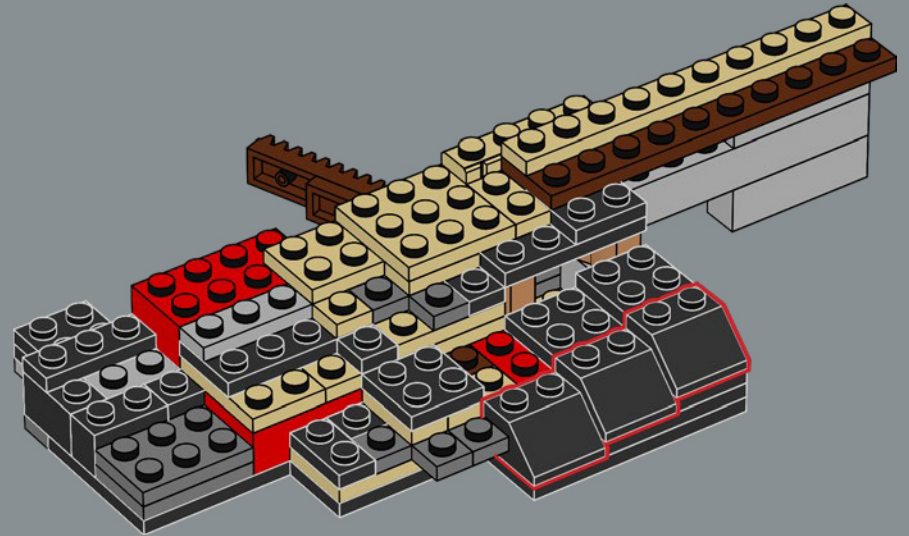



78

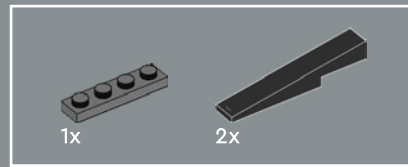
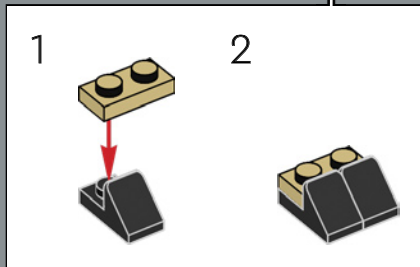
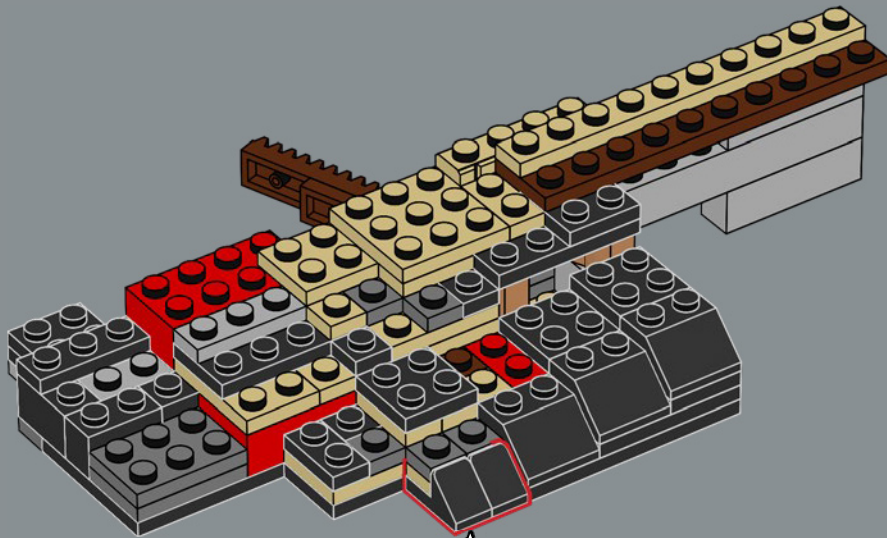

79

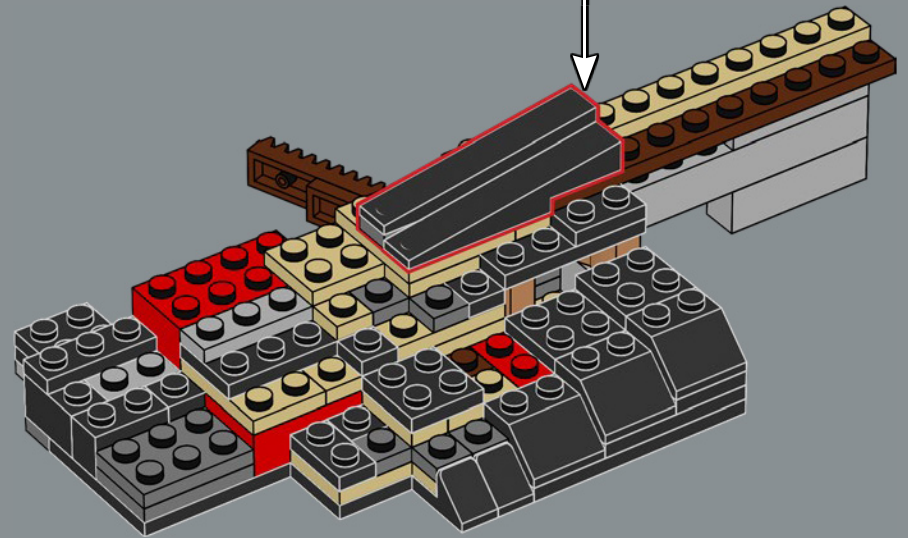
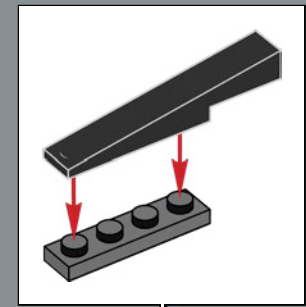



80

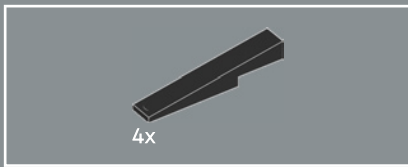
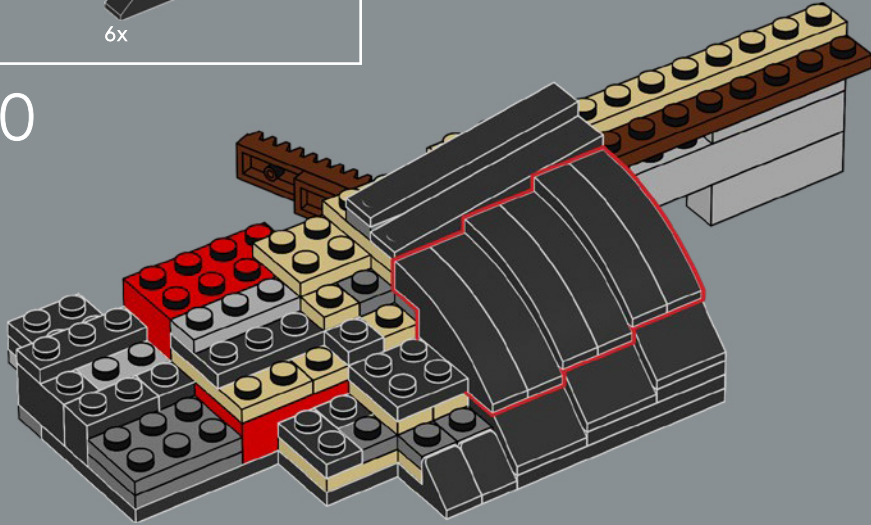

82

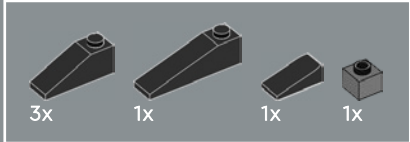
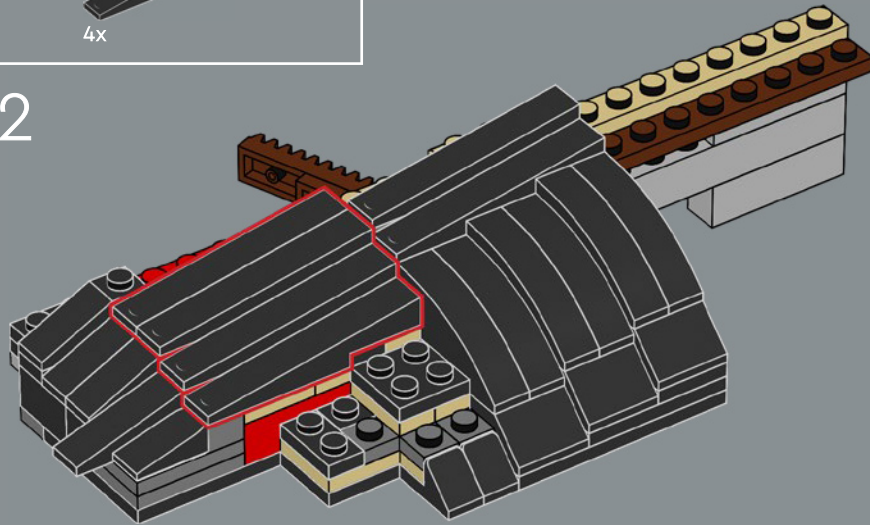

81

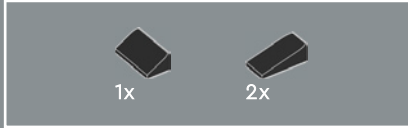
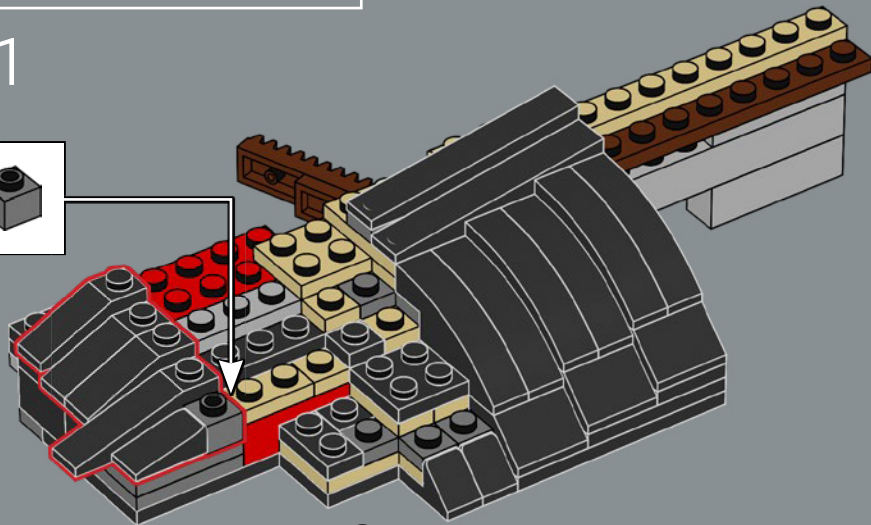
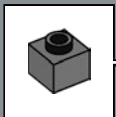

83

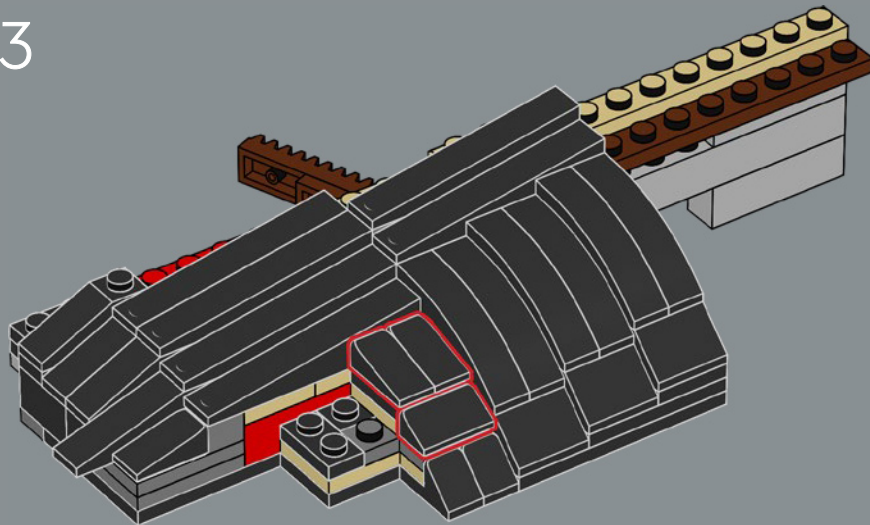

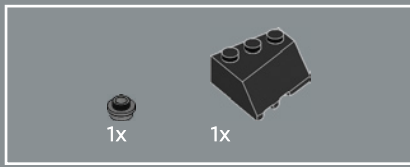

84

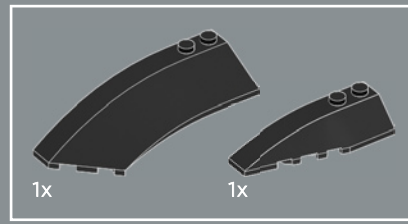
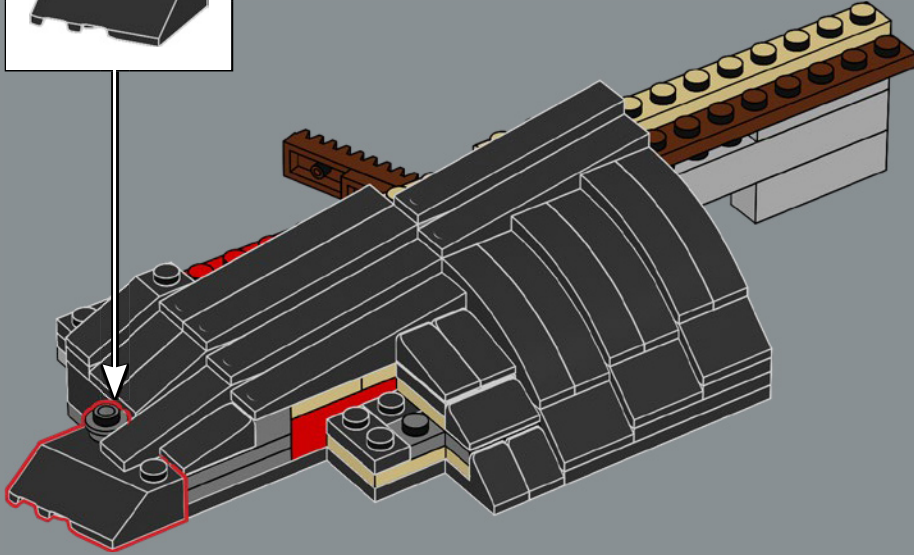
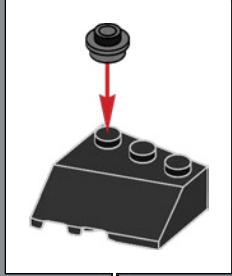

85

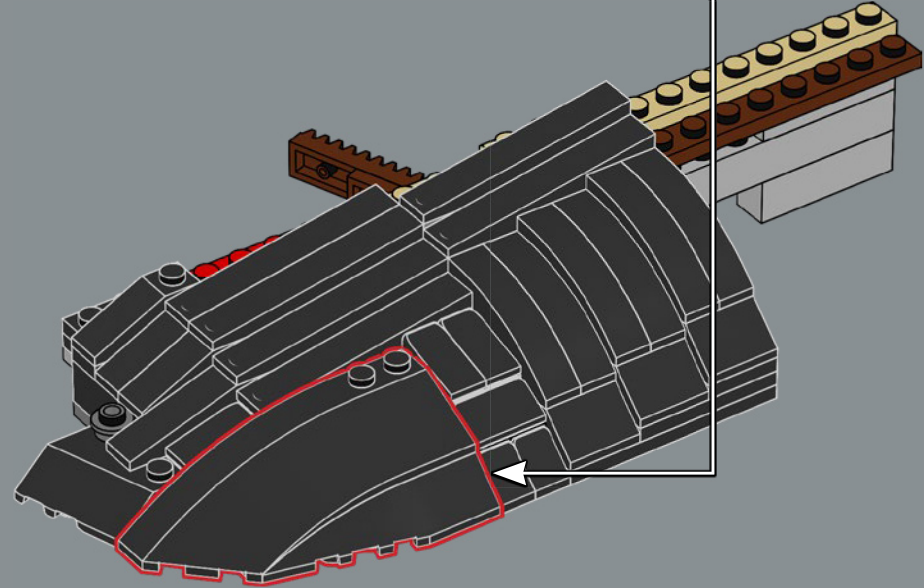
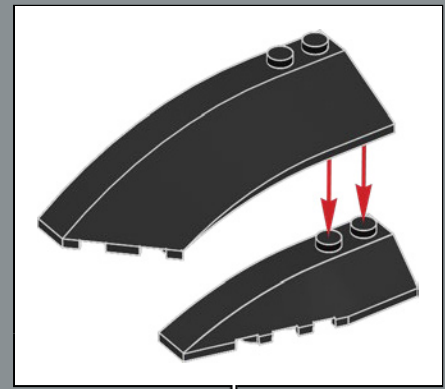



Gli elementi marroni "cremagliera" con barra dentata LEGO® Technic 1x4 sono ideali per le scalette in legno.

86

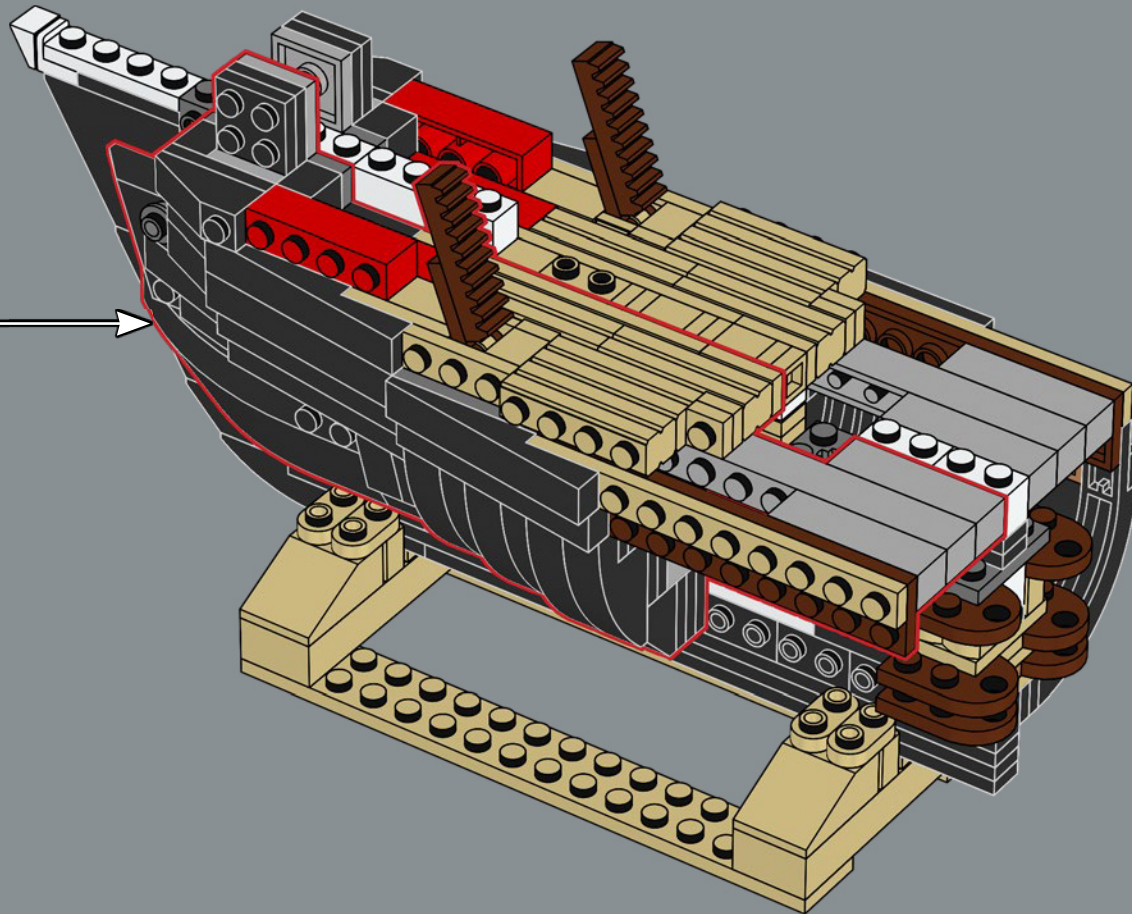

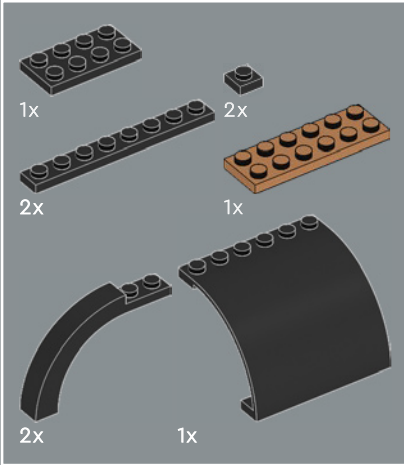
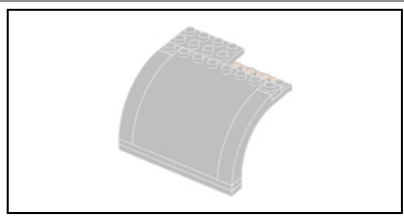

87

1

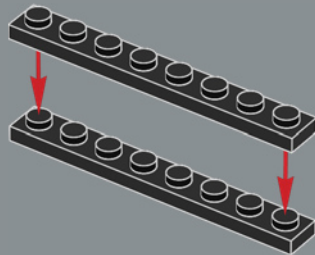

2

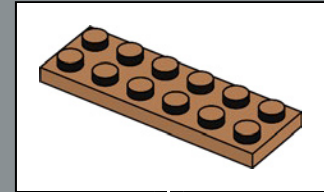
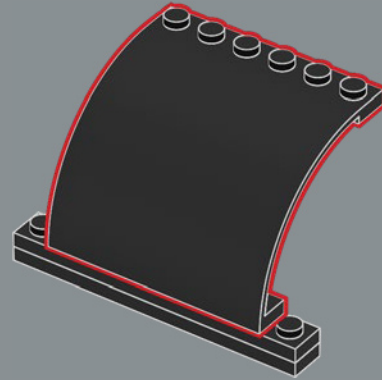

3

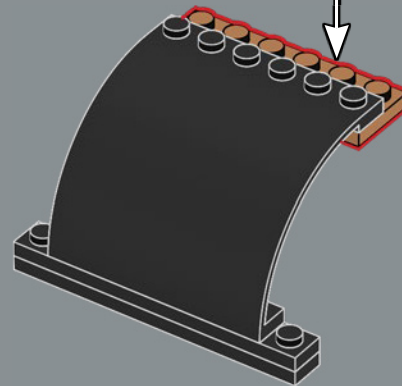

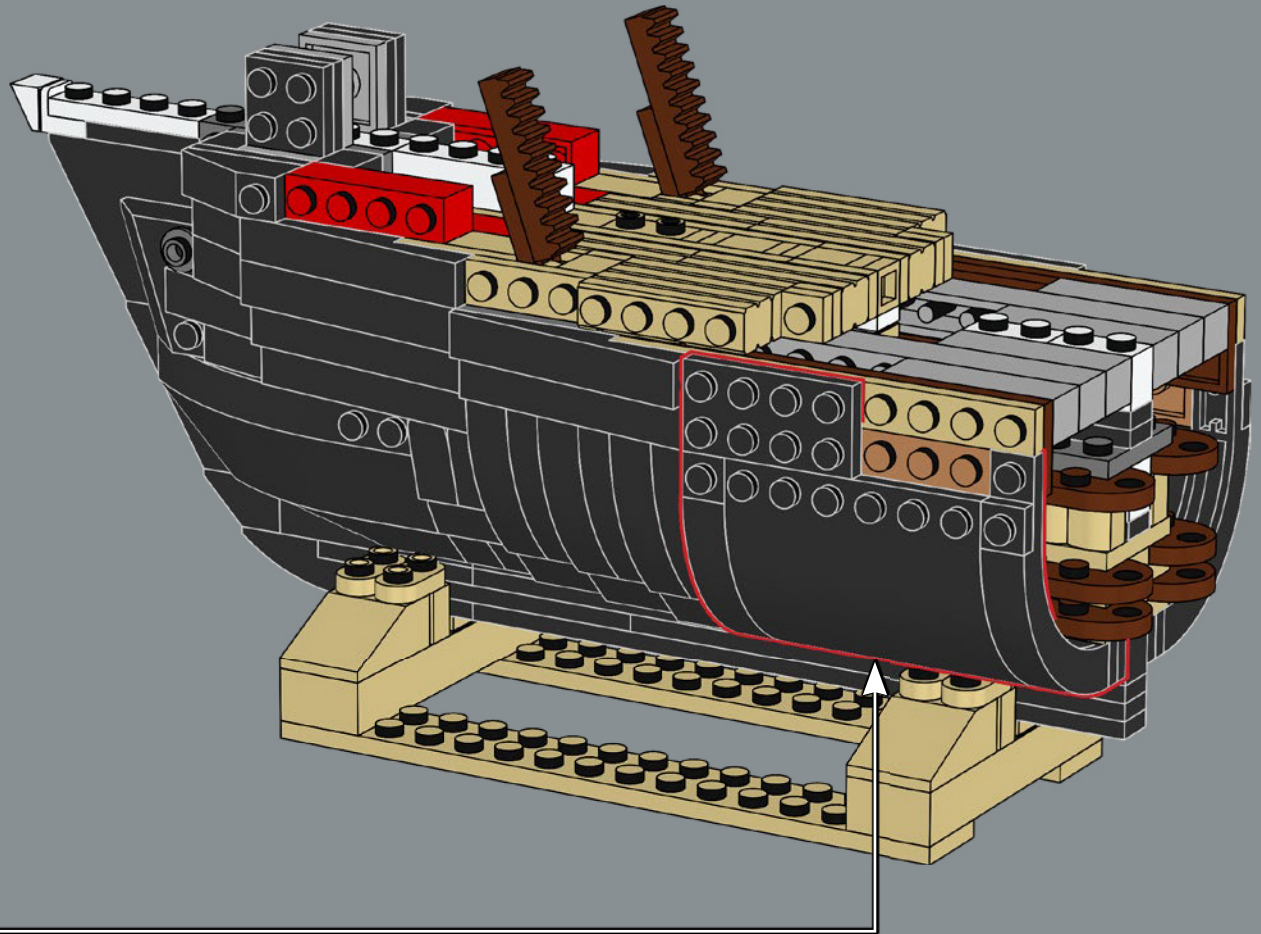
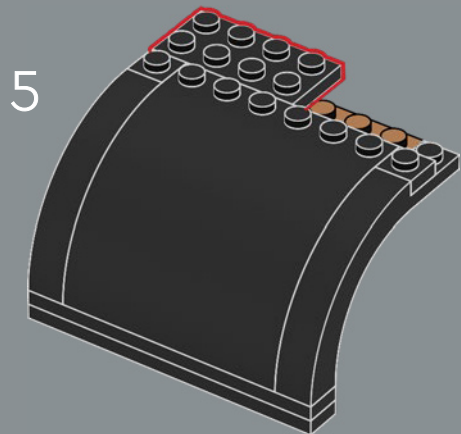
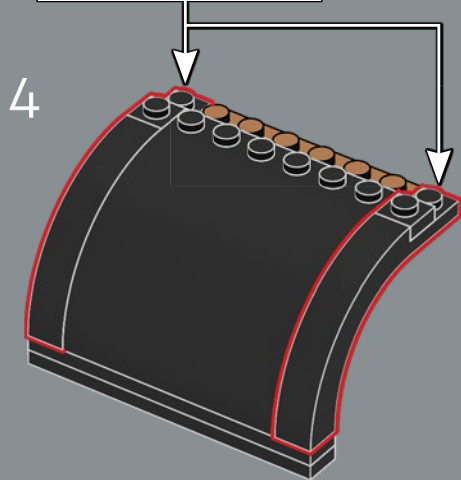
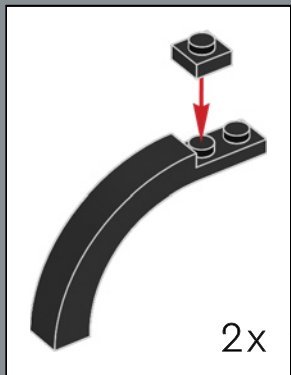

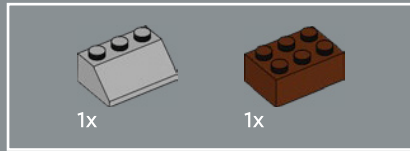

88

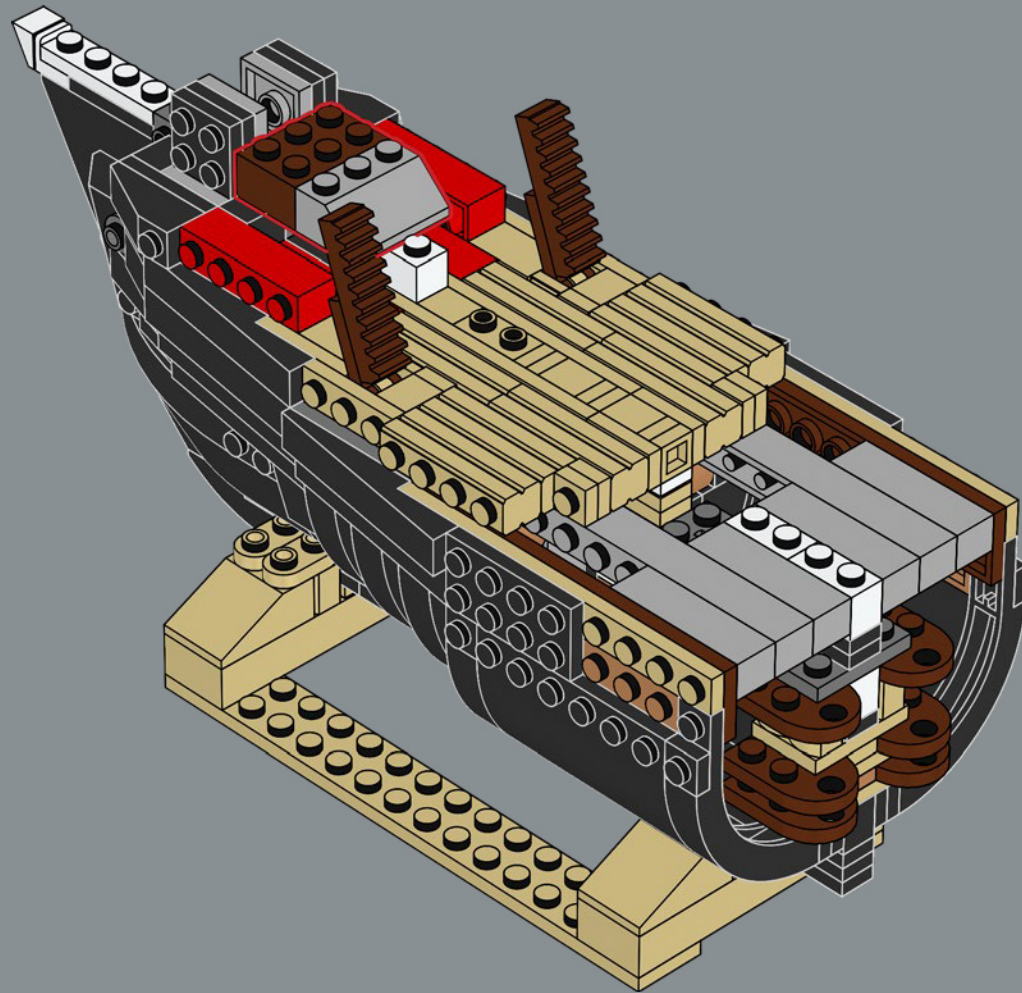



2x

89

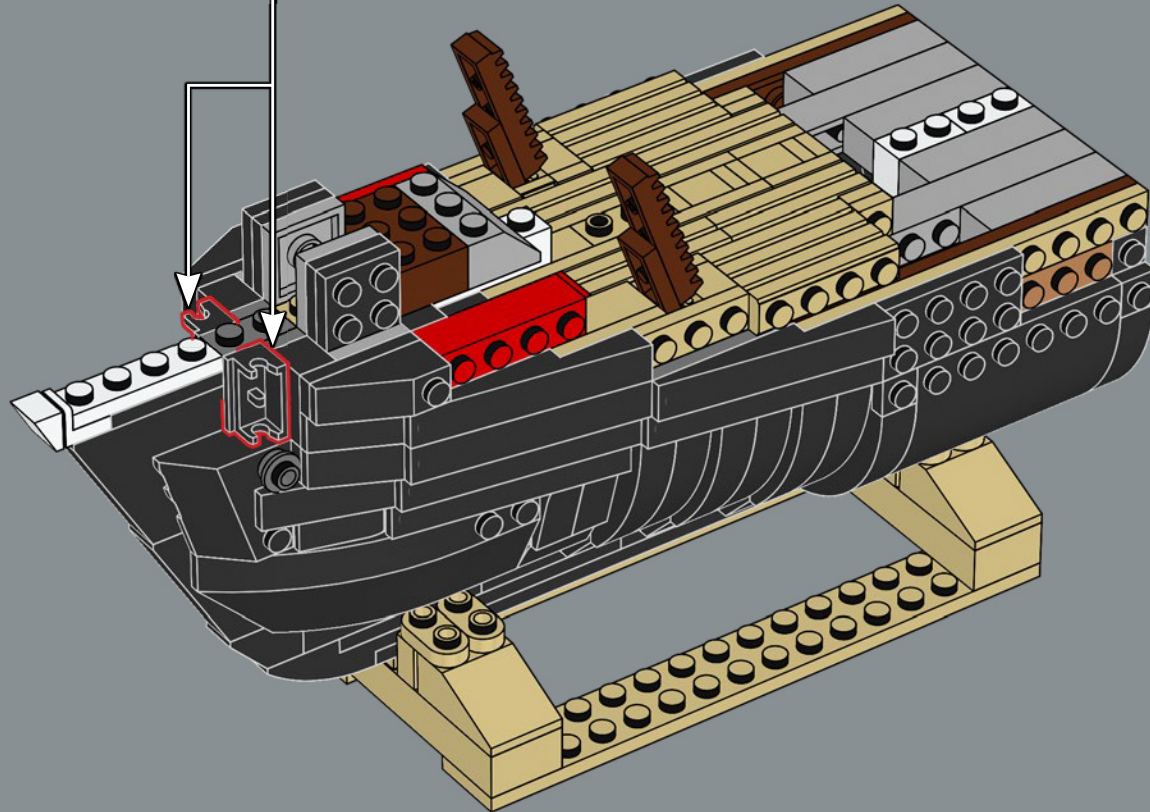
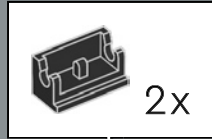

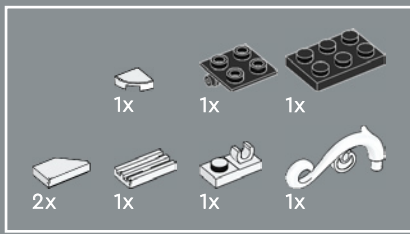

90

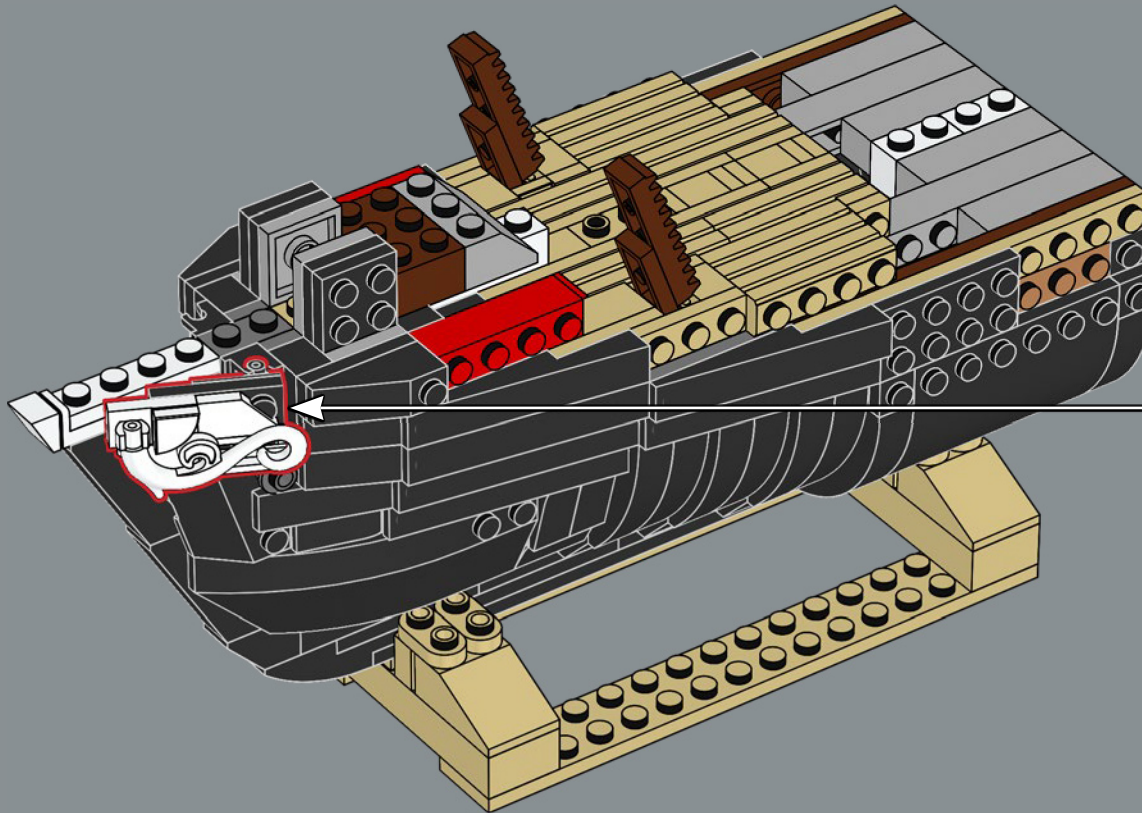
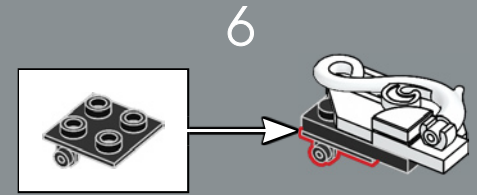
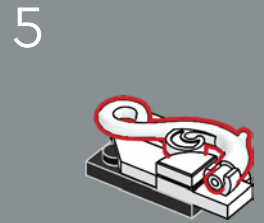
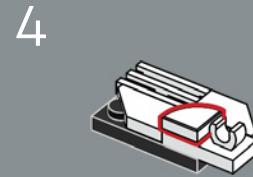
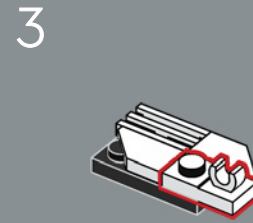
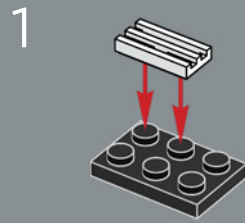

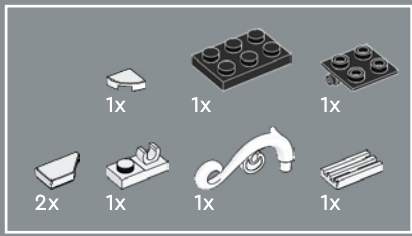

91

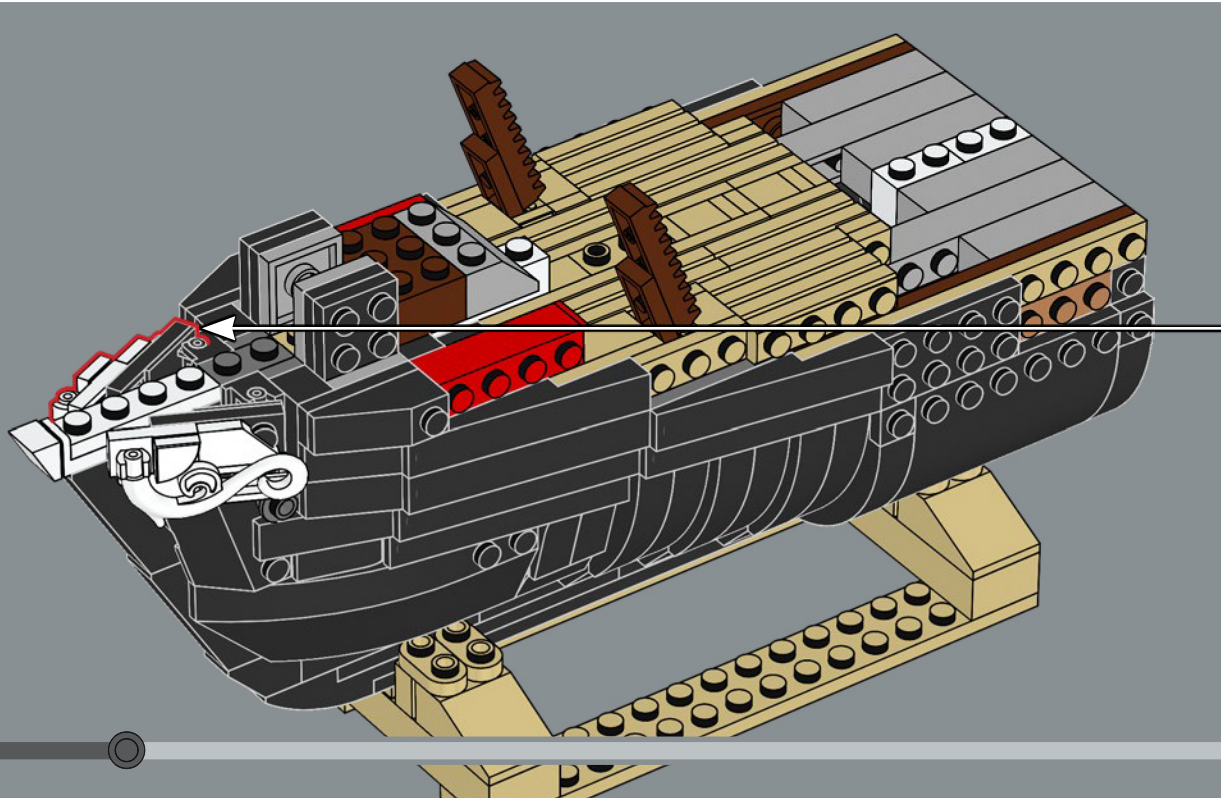
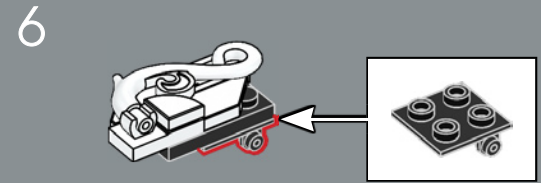
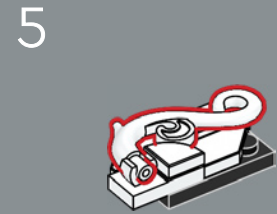
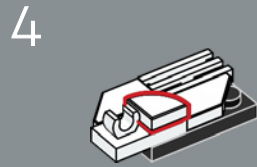
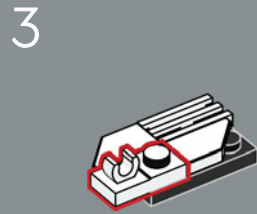
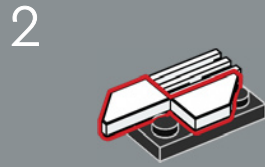
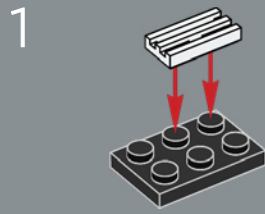

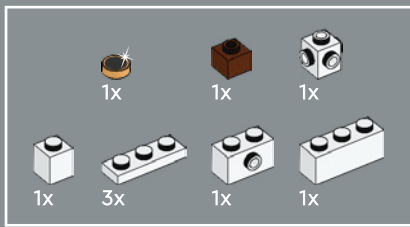

92

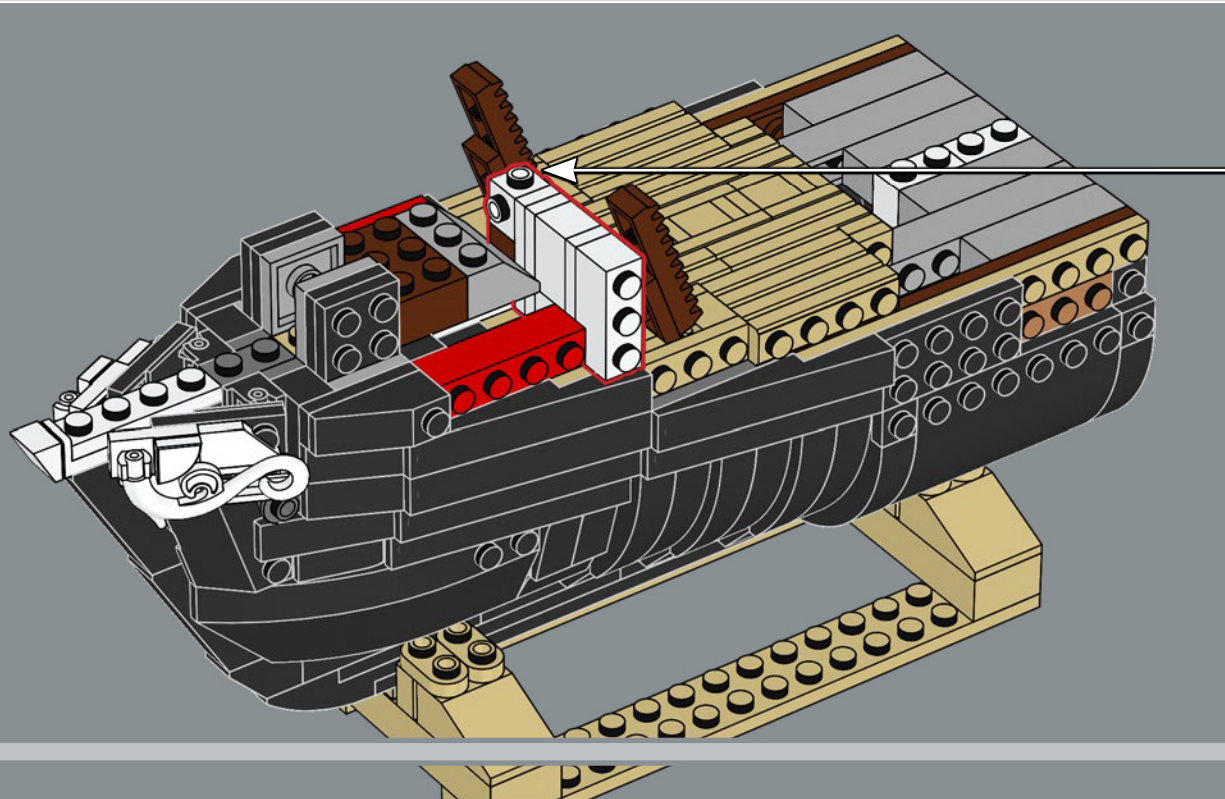
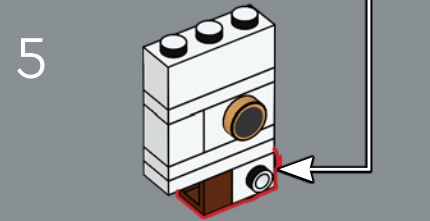
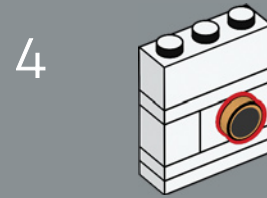
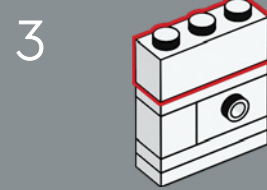
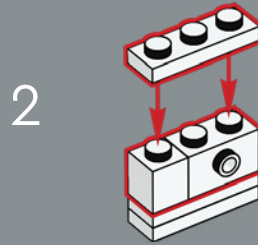
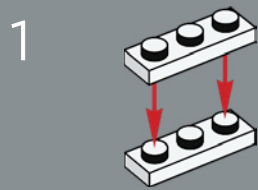

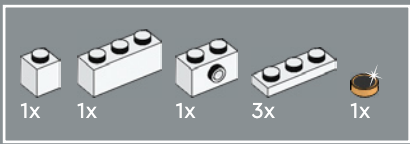

93

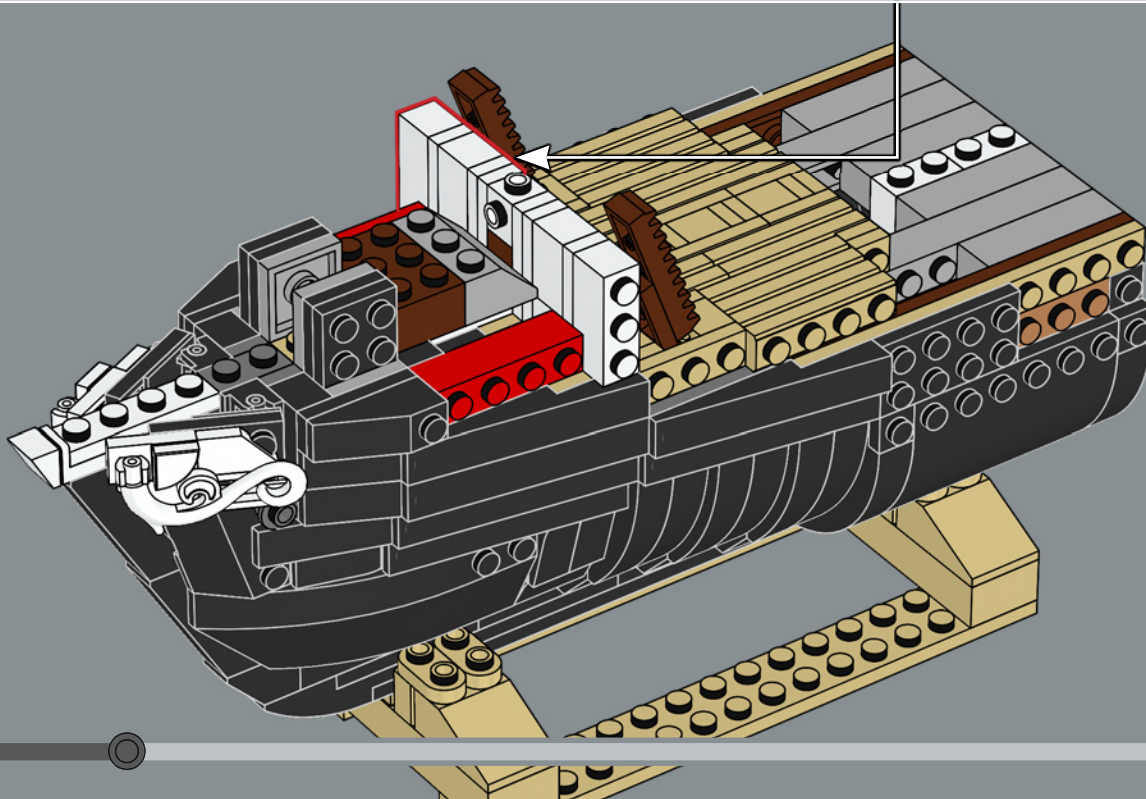
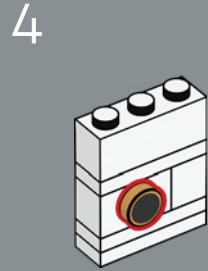
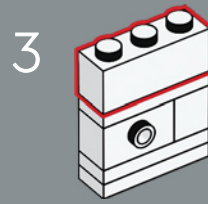
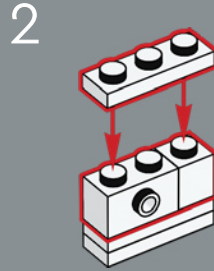
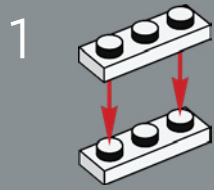

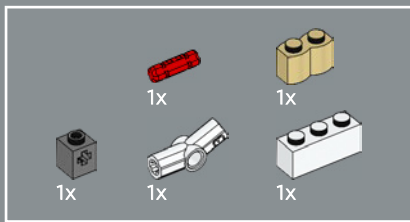

94

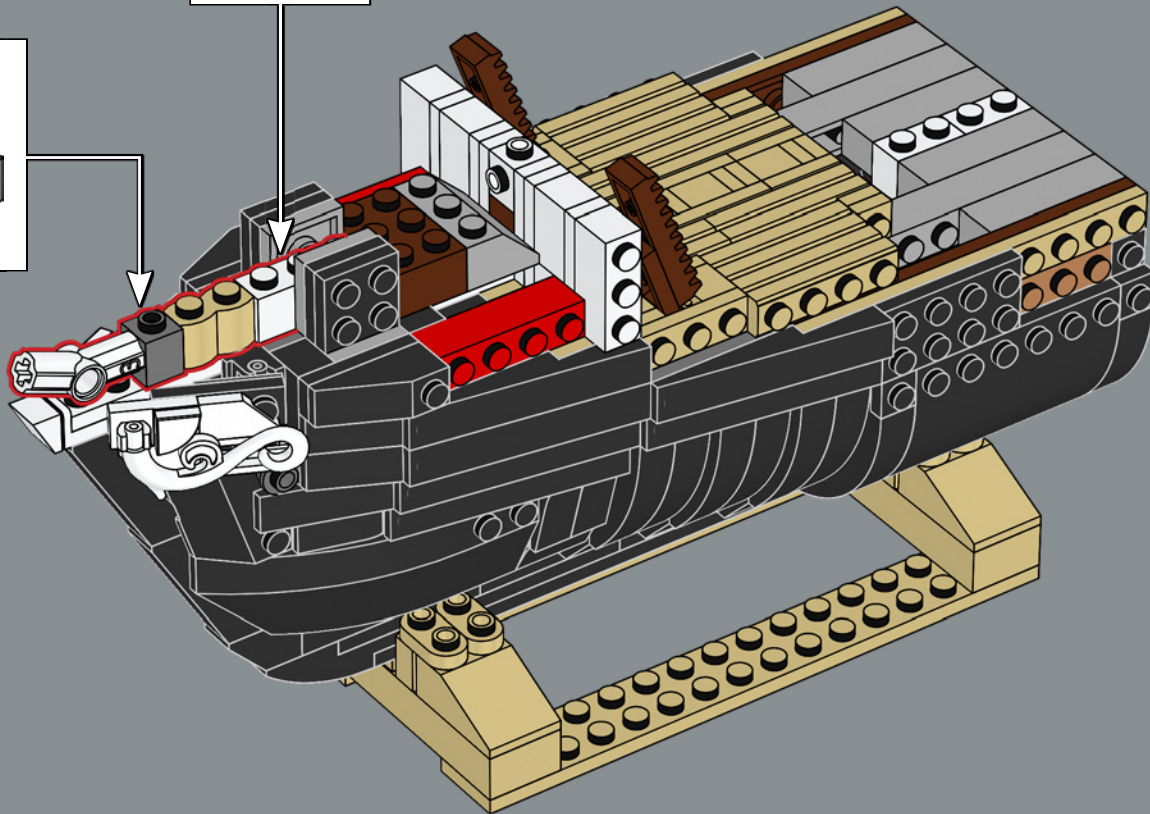
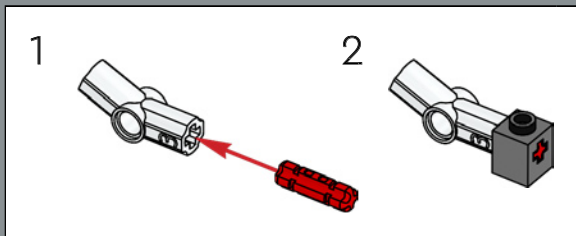
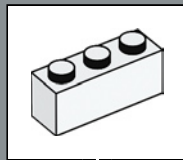

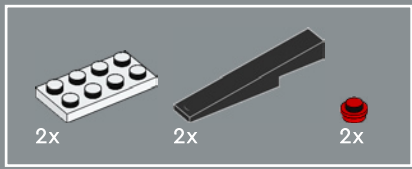

95

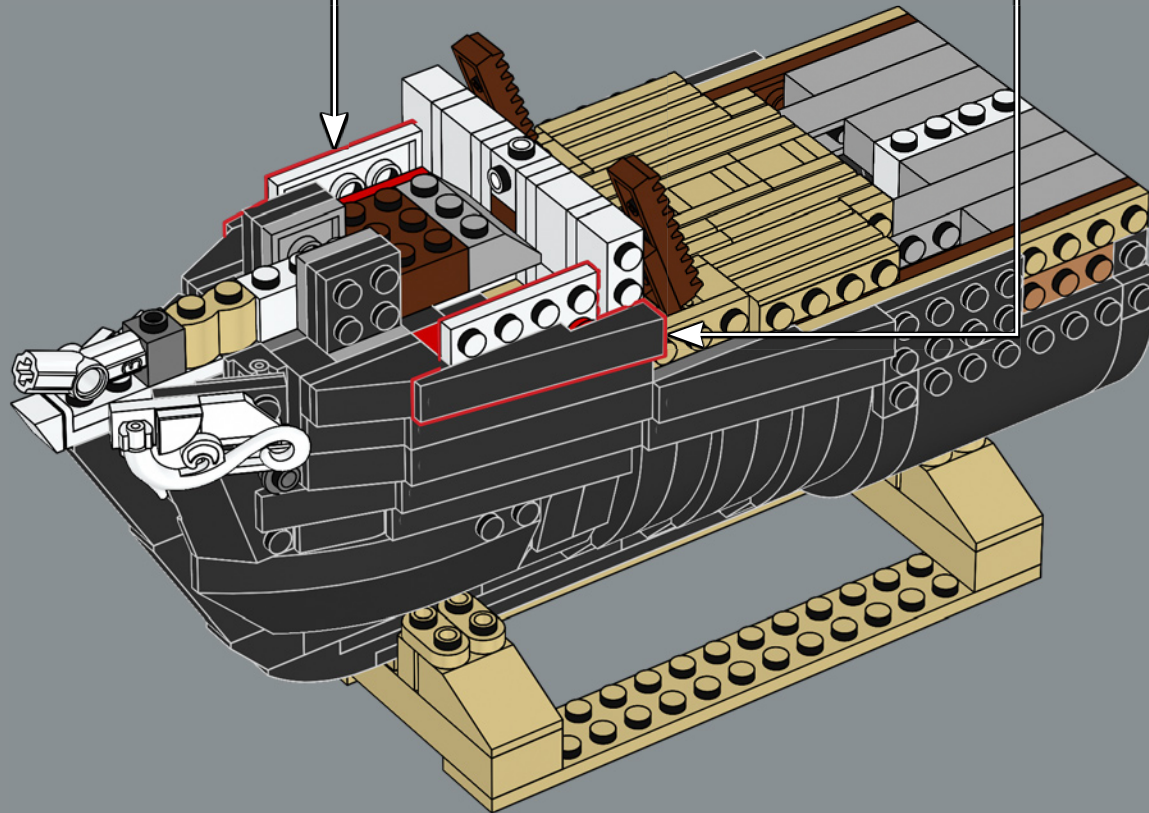
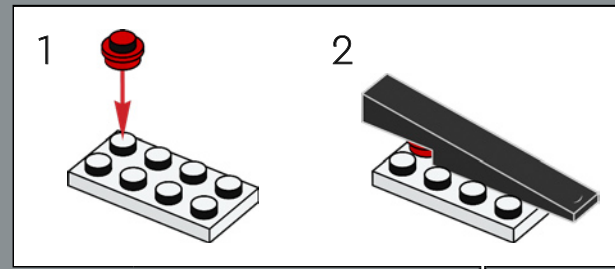
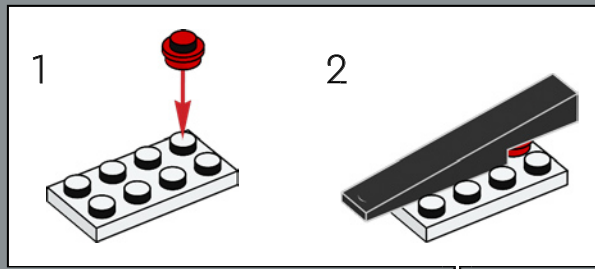

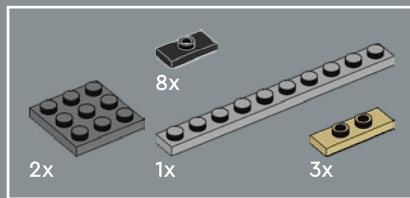

96

1

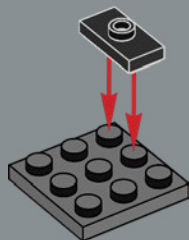

2

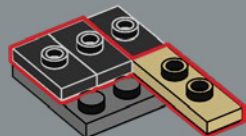

3

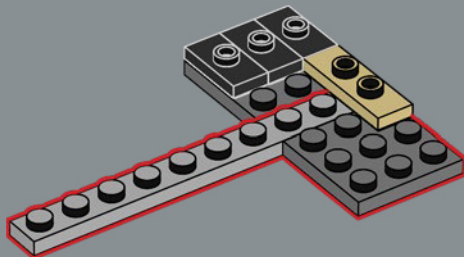

4

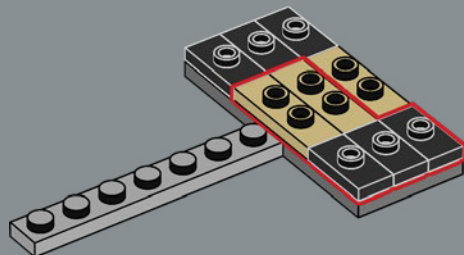

5

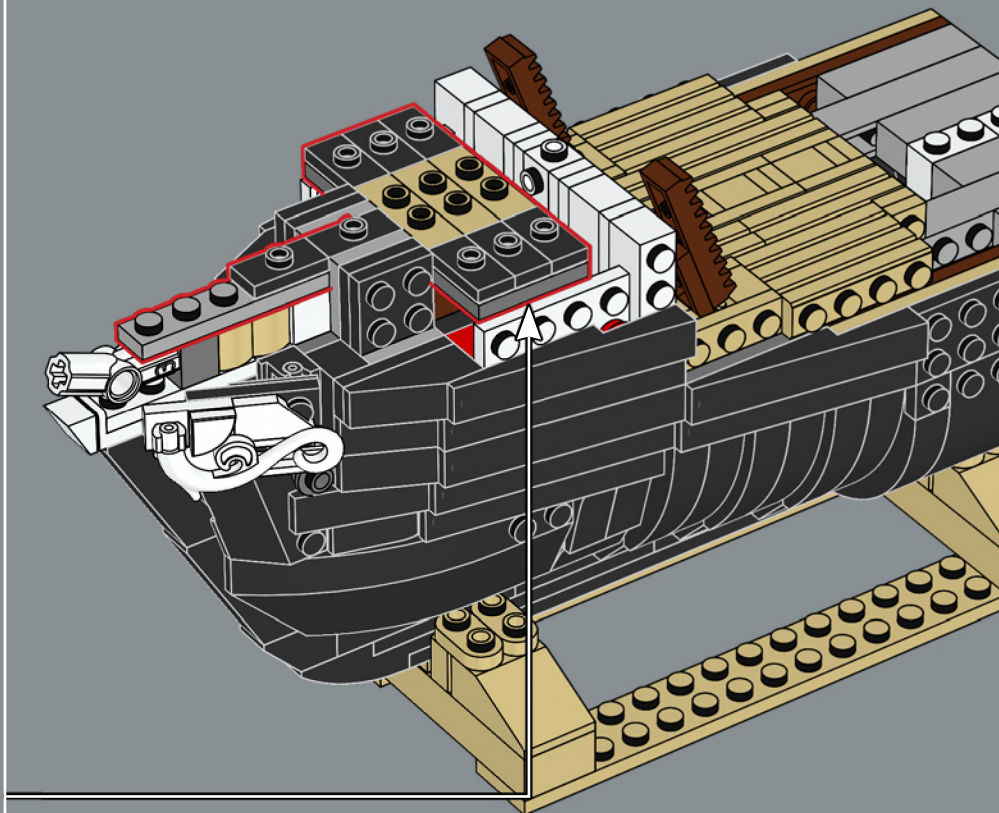
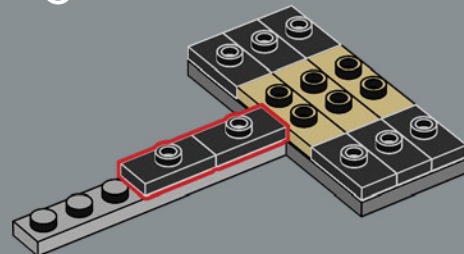

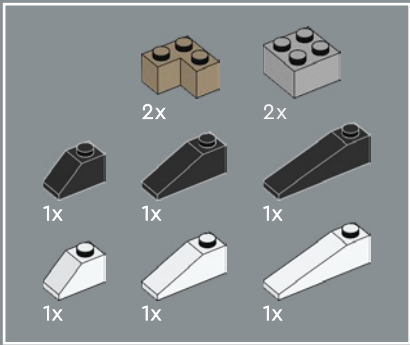

97

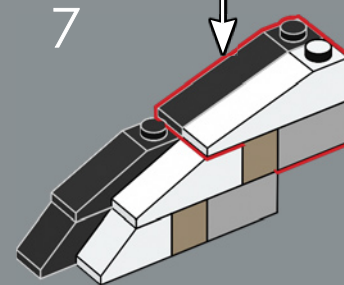
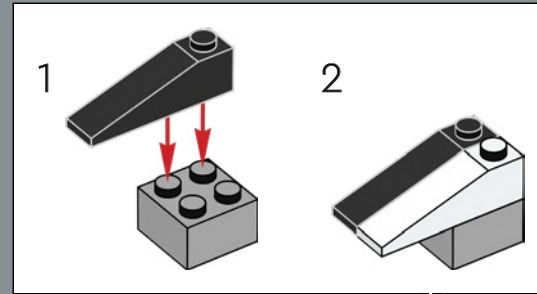
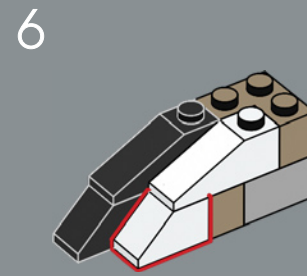
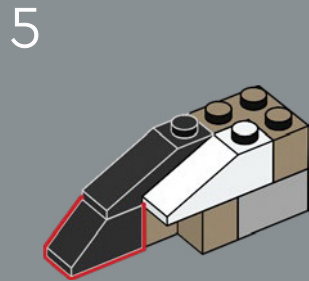
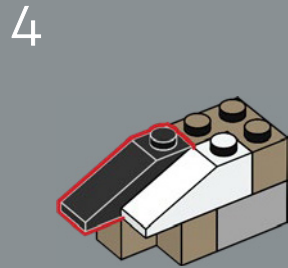
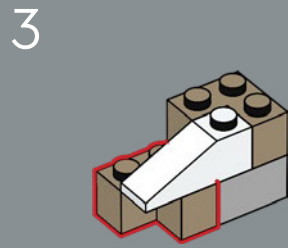
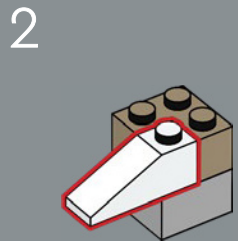
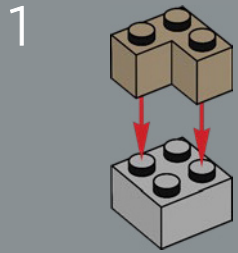

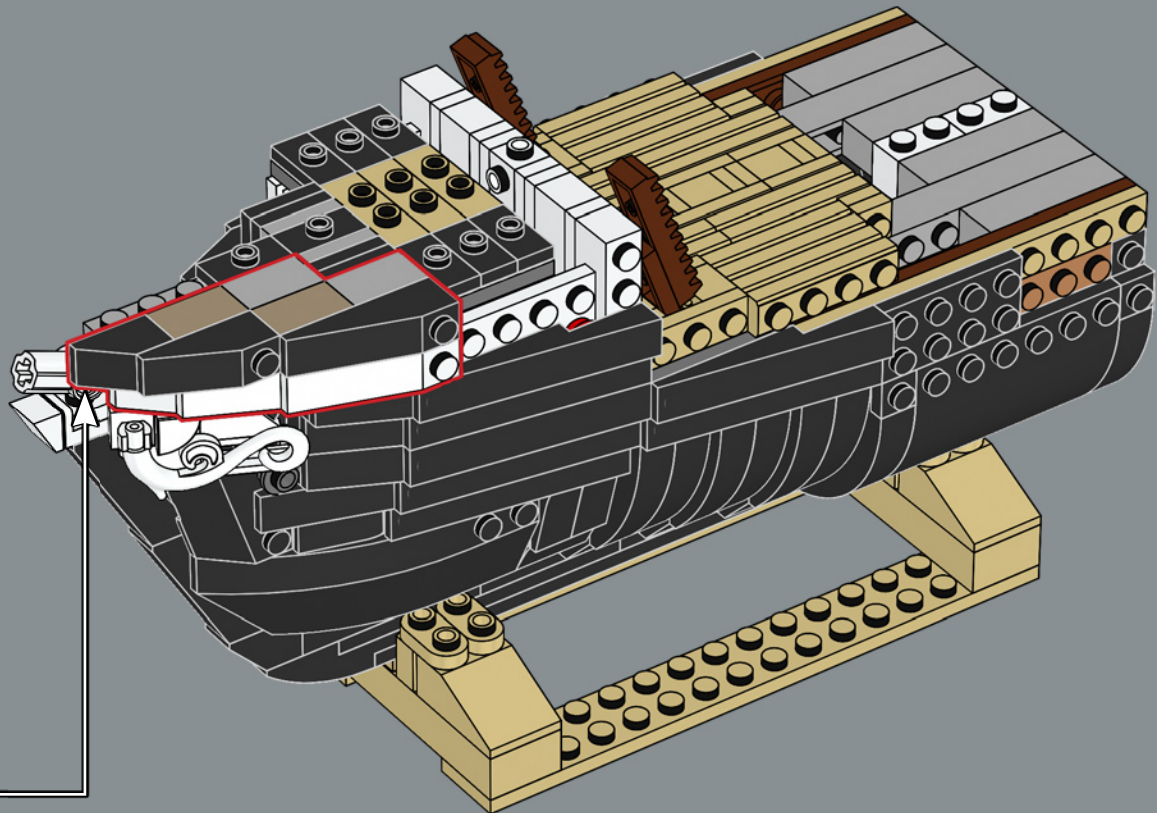

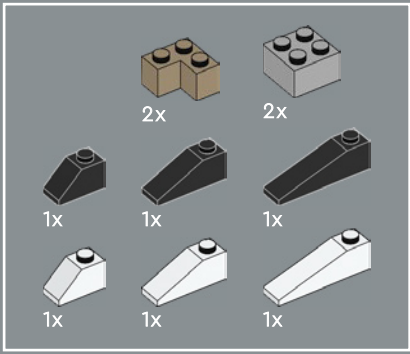

98

1

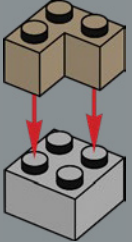

2

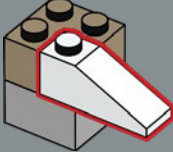

3

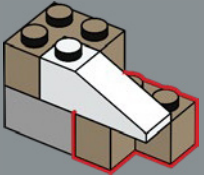

4

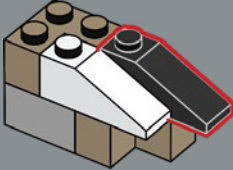

5

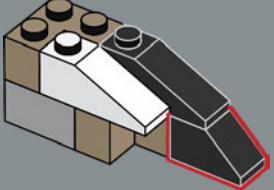

6

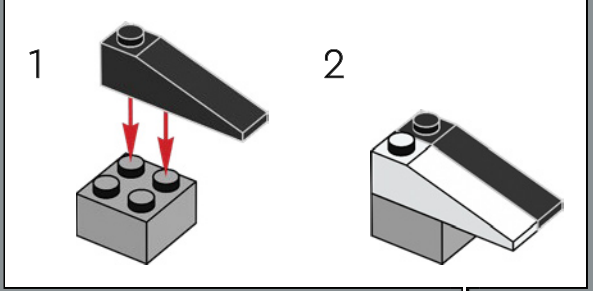
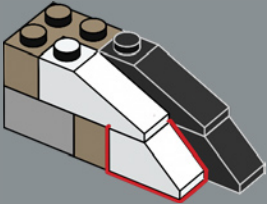

7

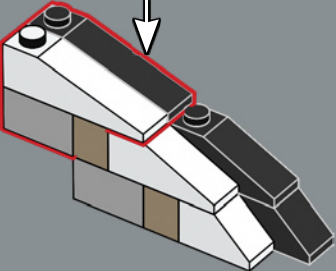

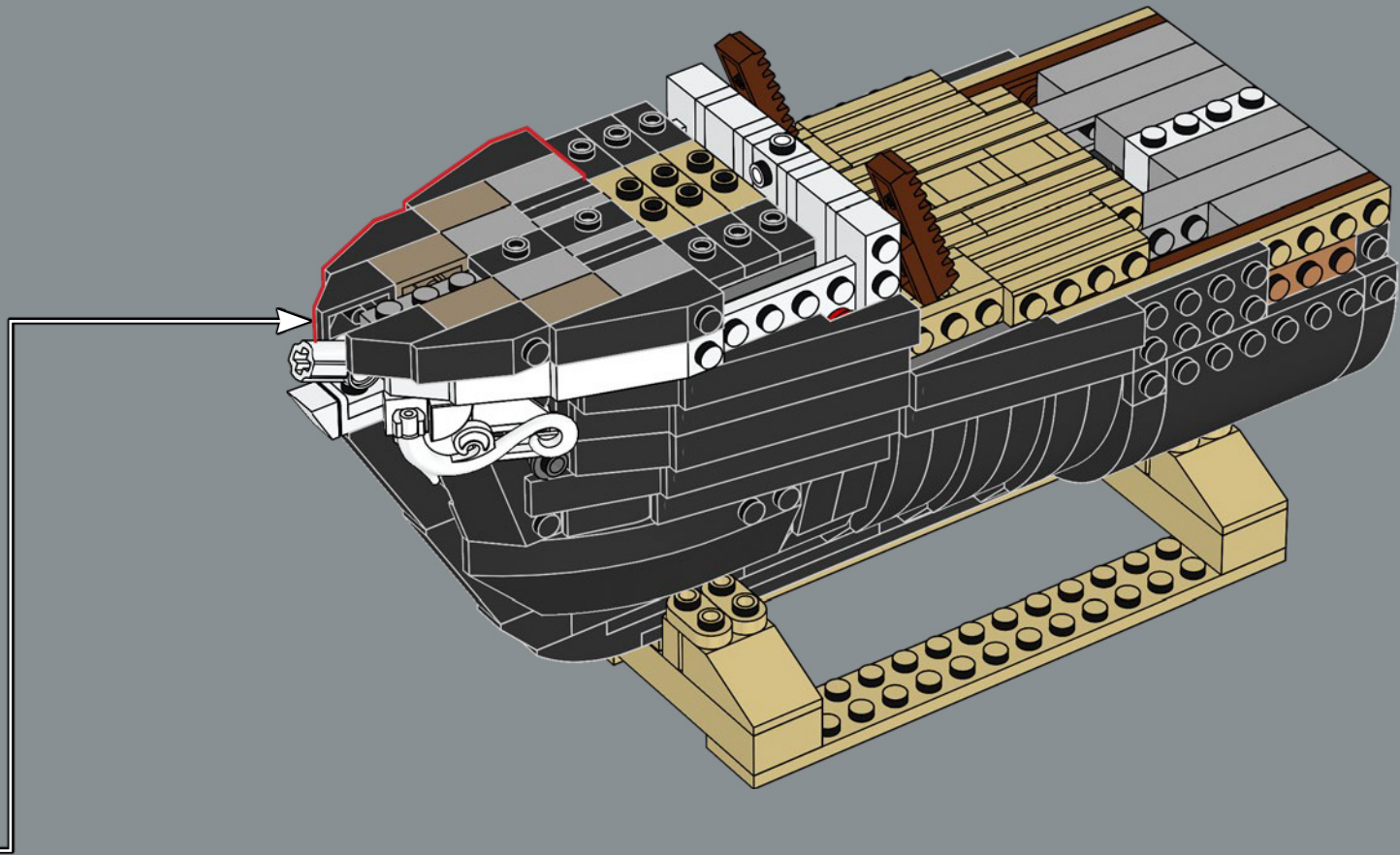



1x

99

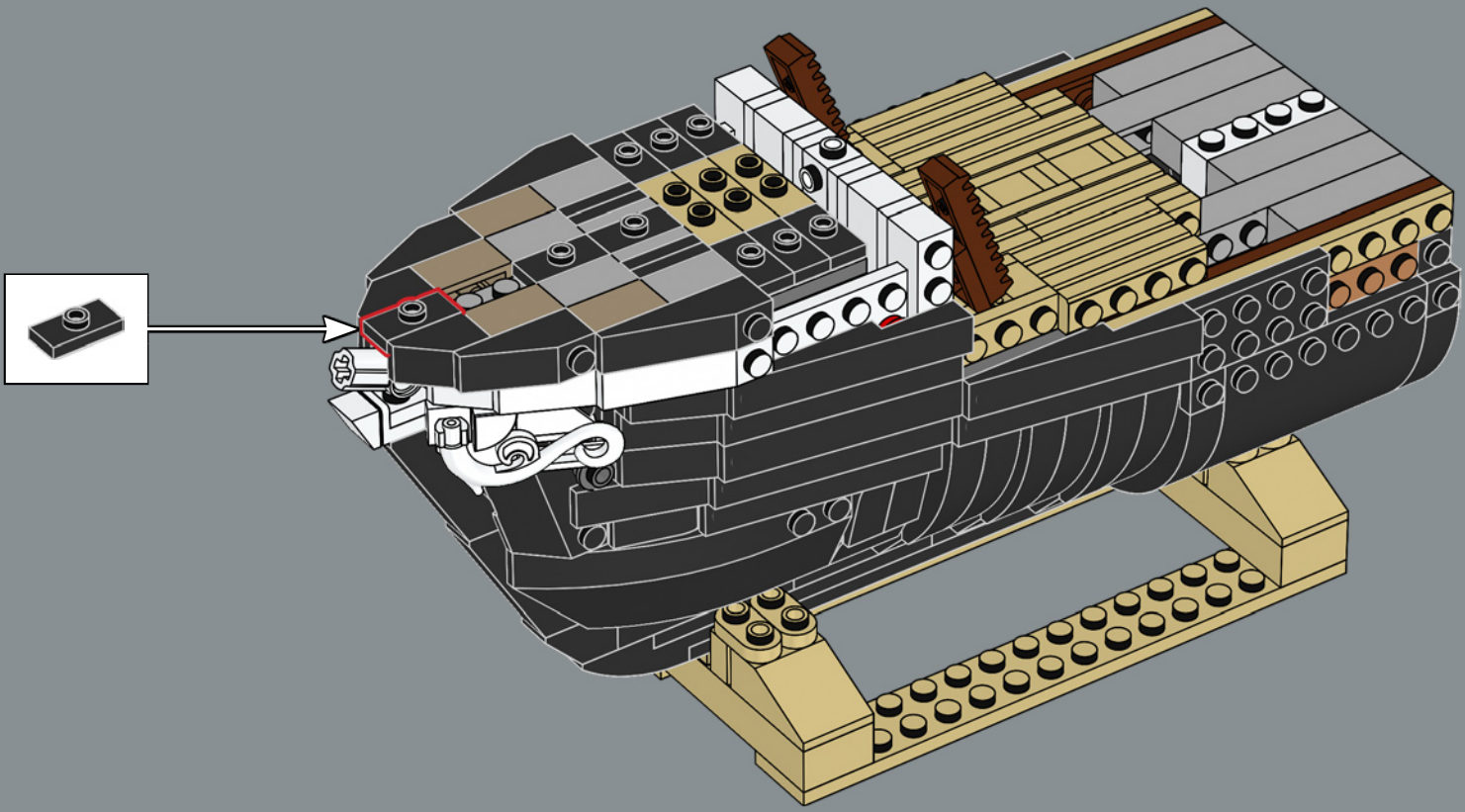

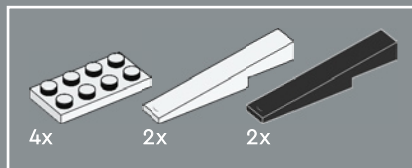

100

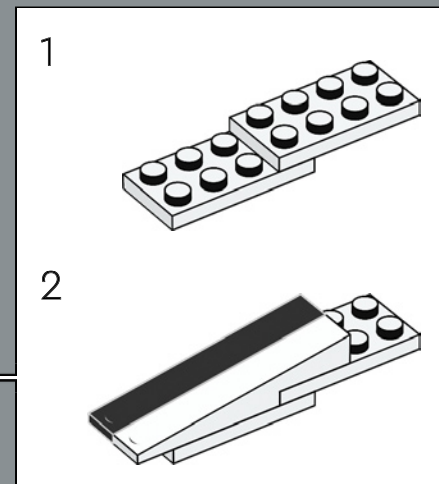
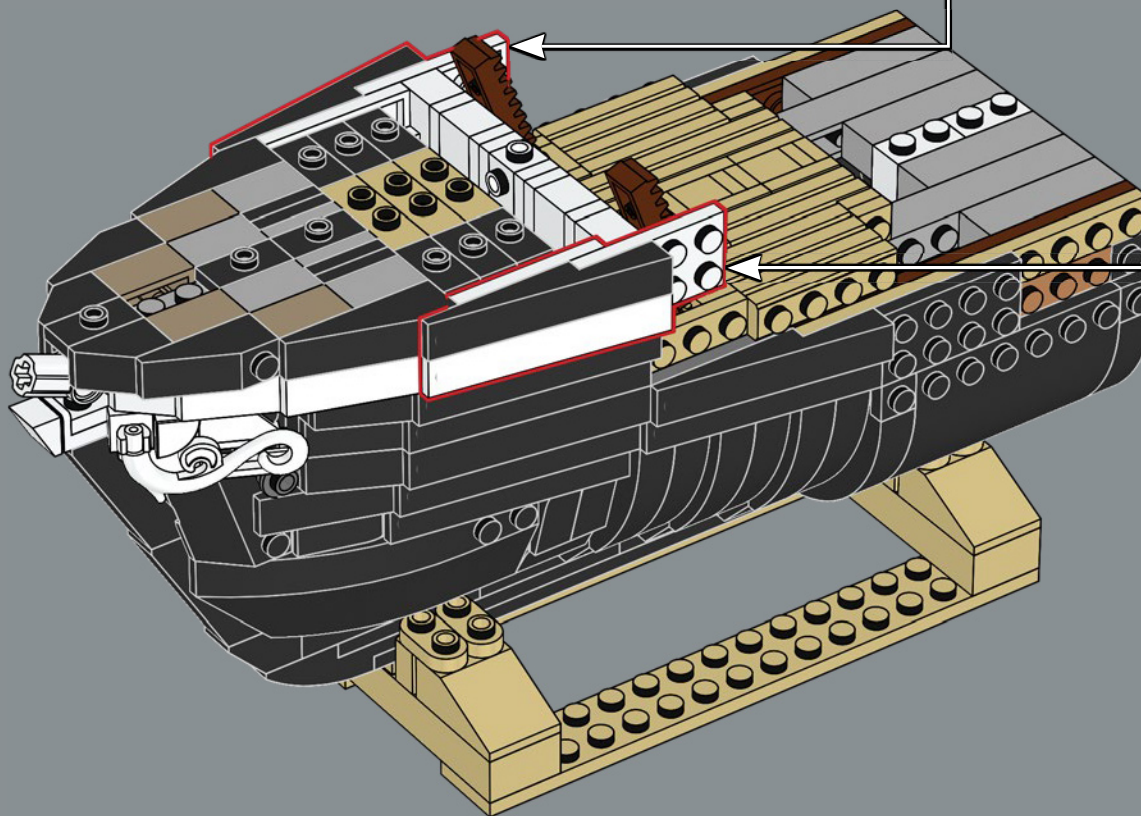
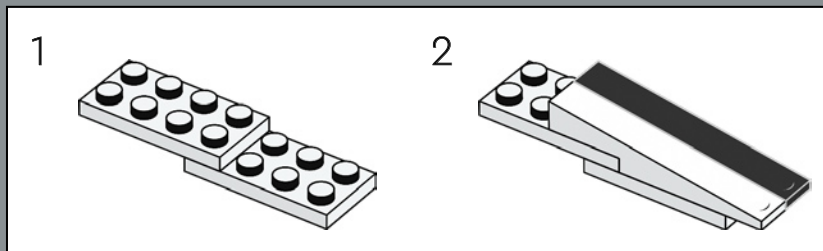

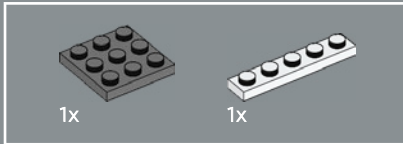
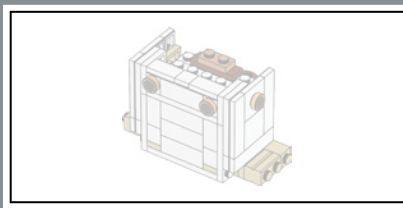

101

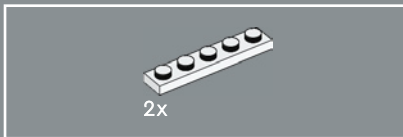
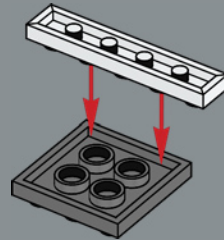

102

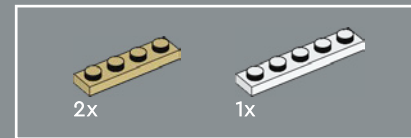
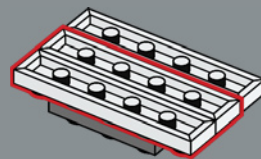

103

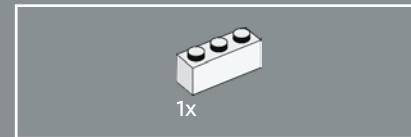
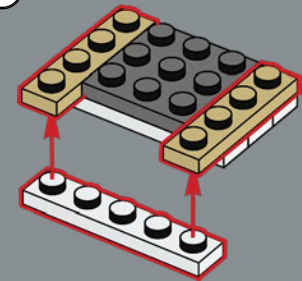

104

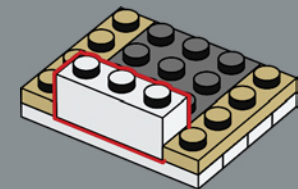

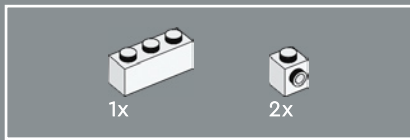

105

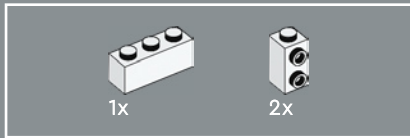
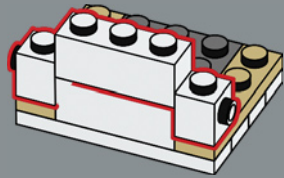

106

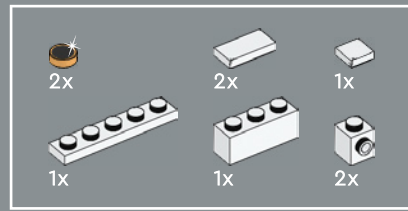
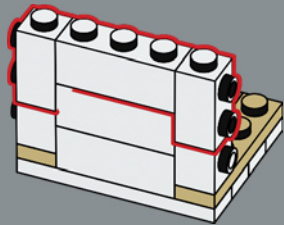

107

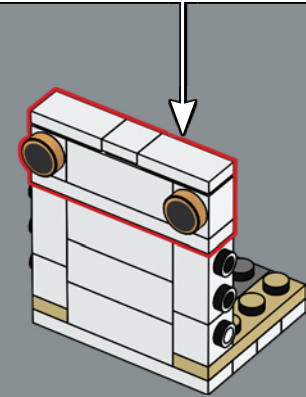
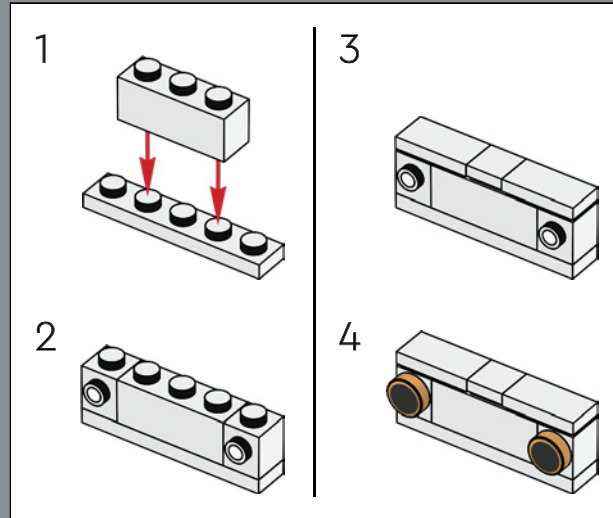



2x

108

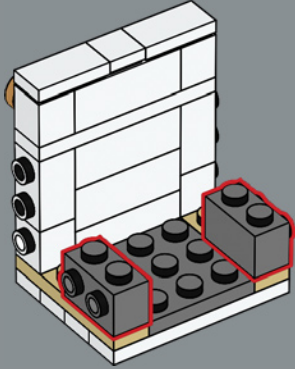

2x

109

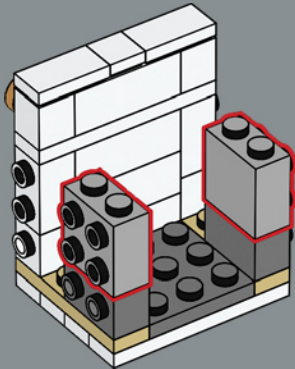

1x

2x

2x

1x

110

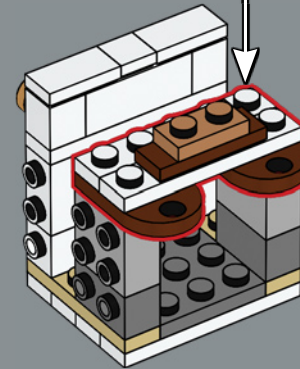
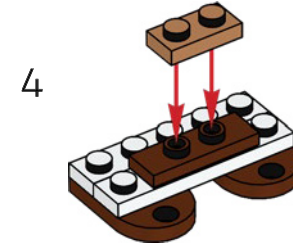
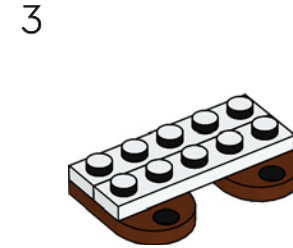
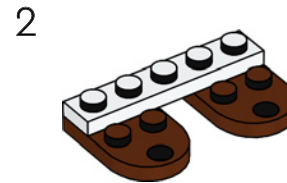
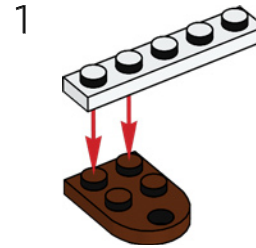

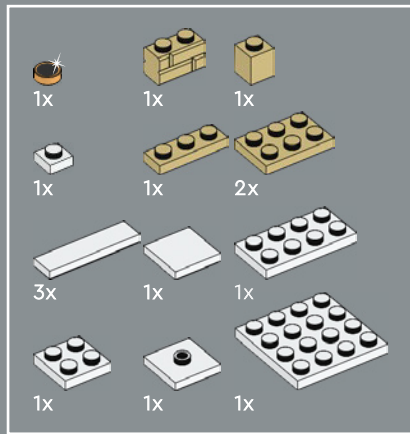

111

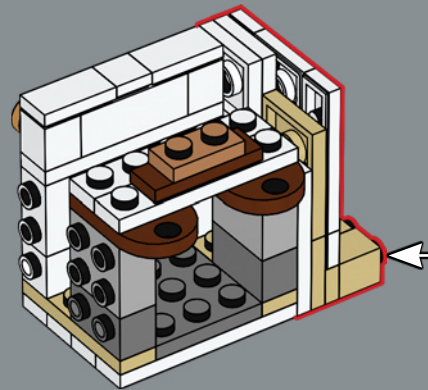
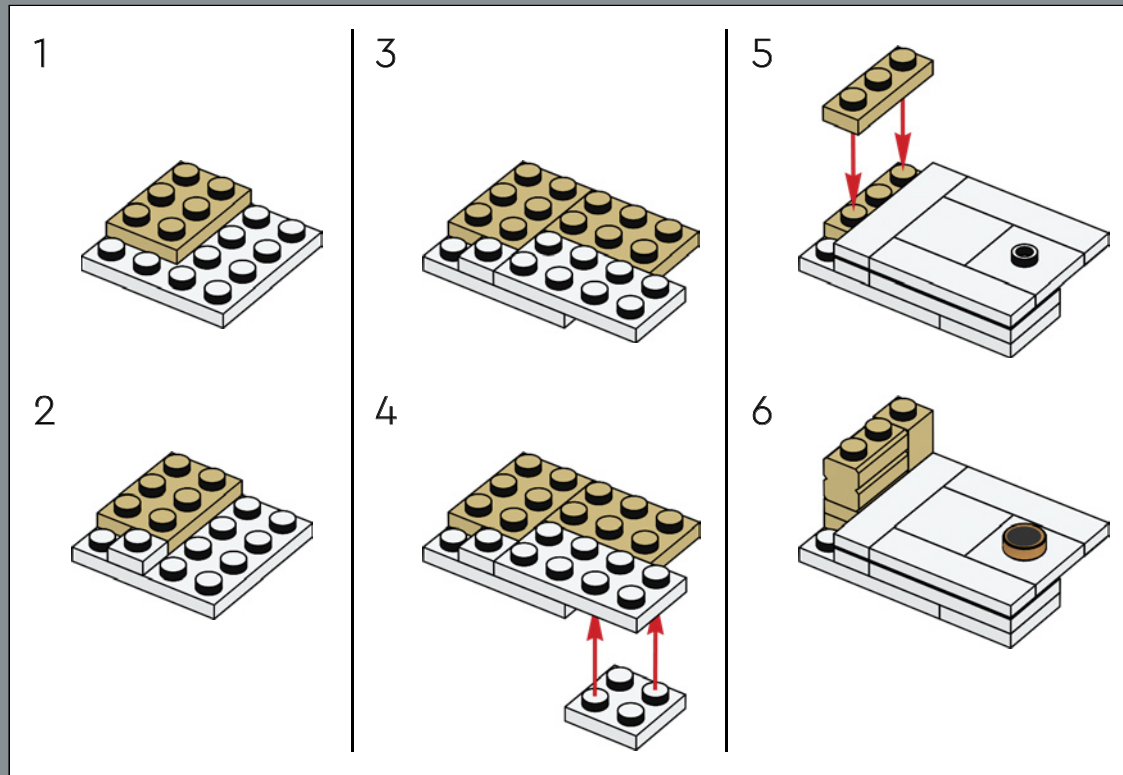

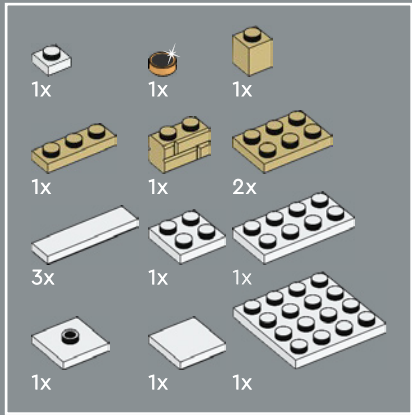

112

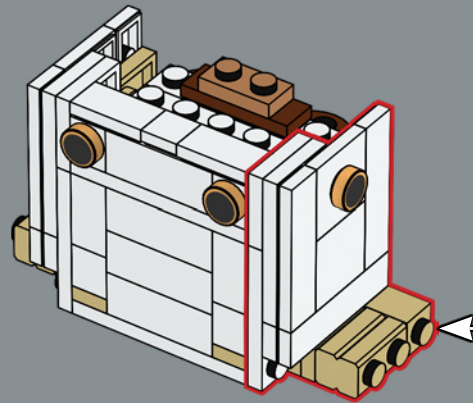
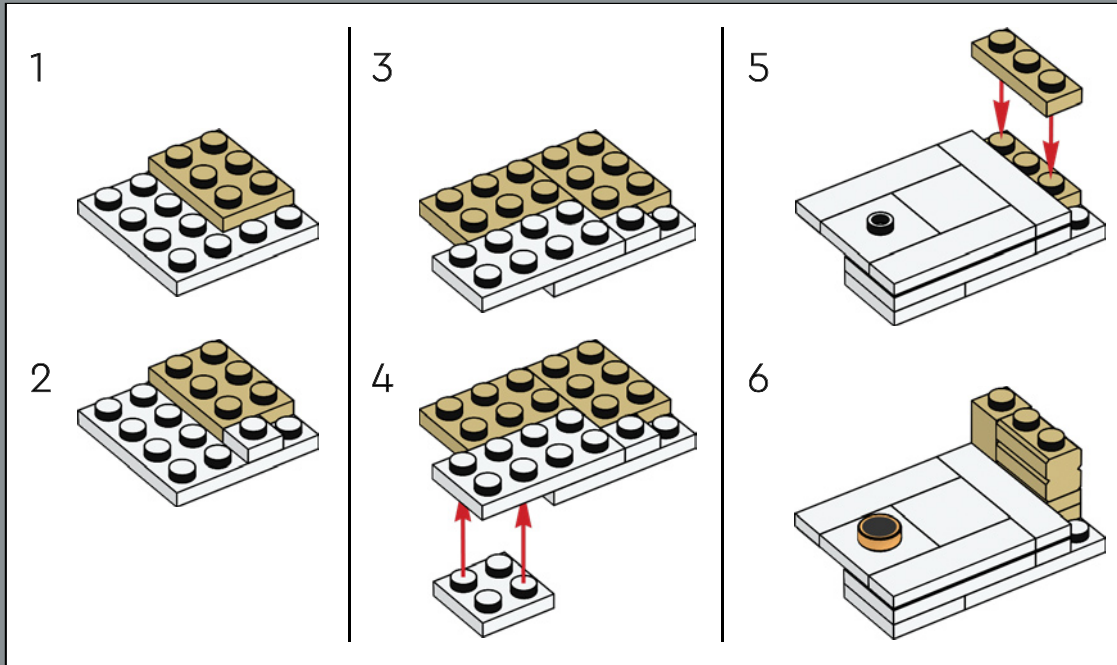

113

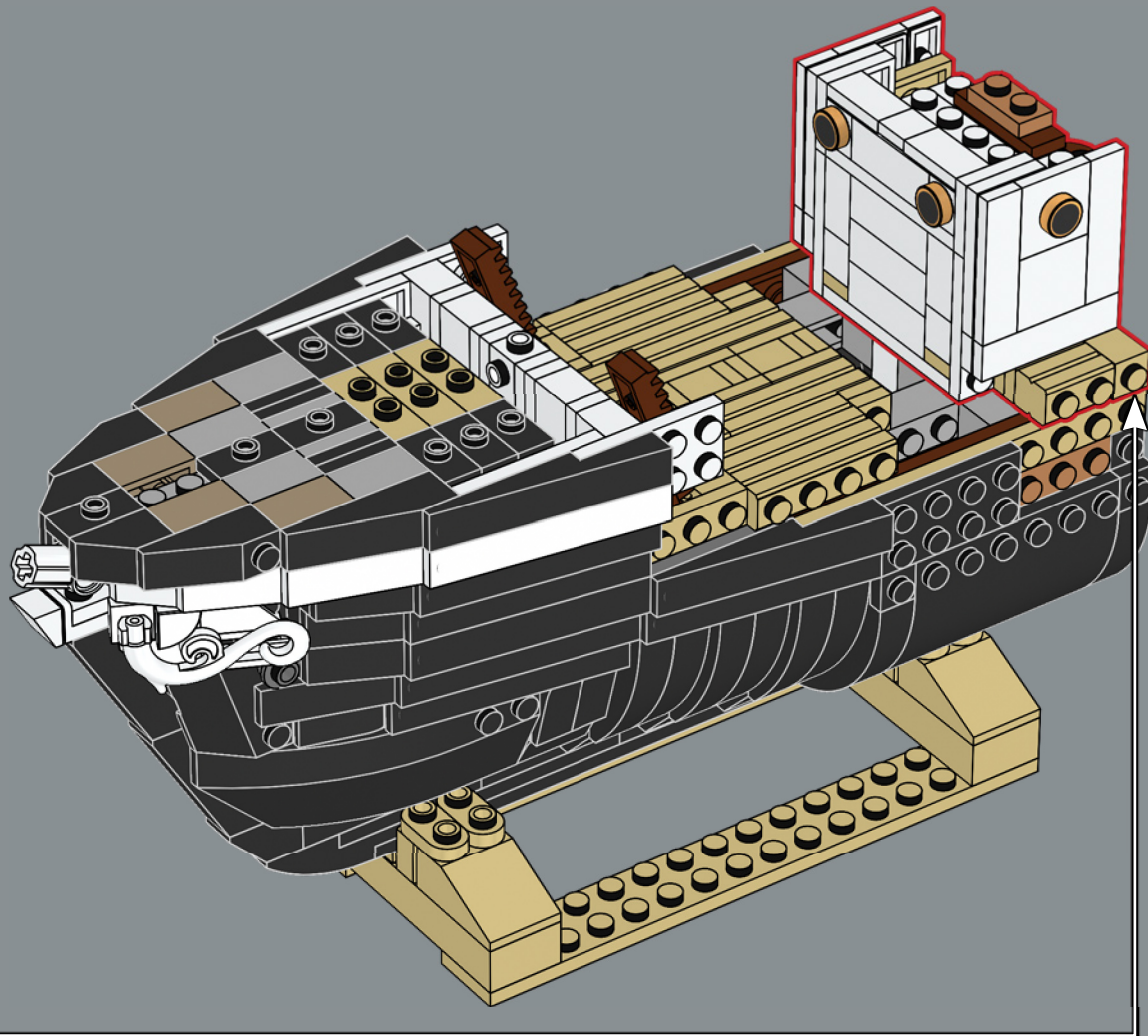

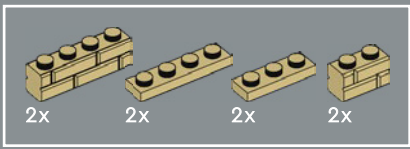

114

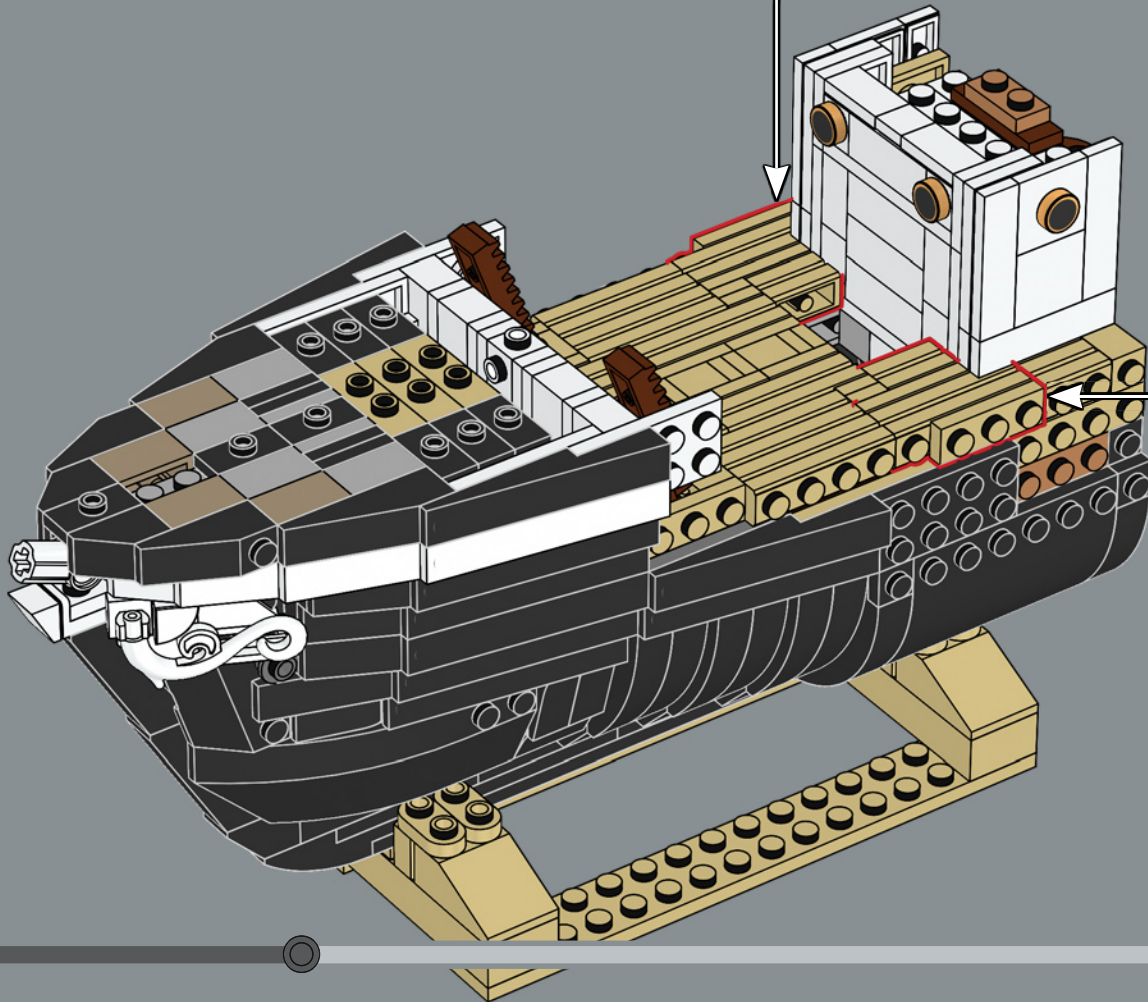
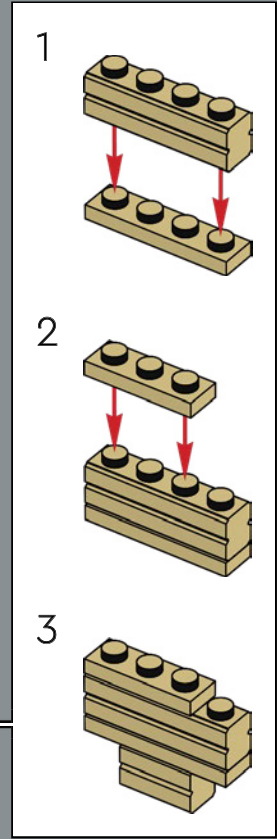
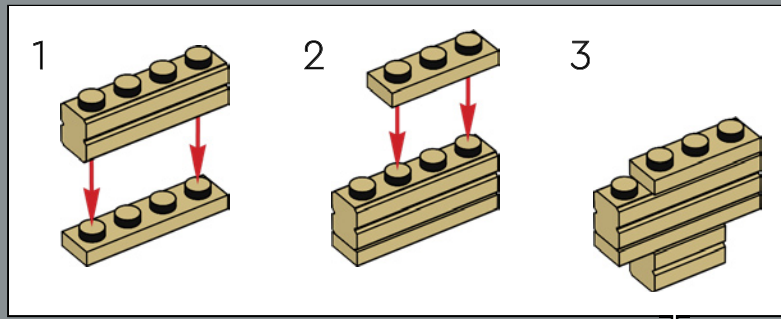

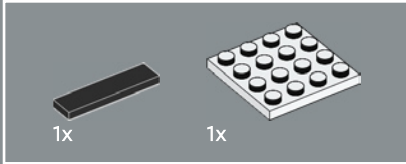
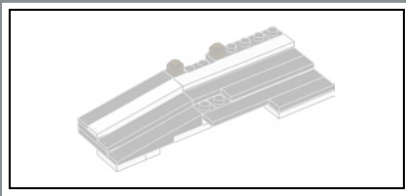

115

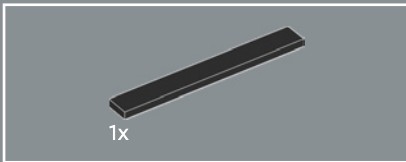
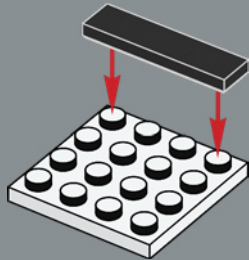

116

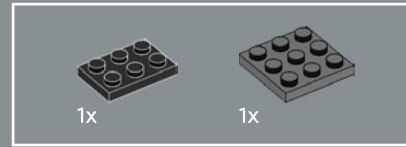
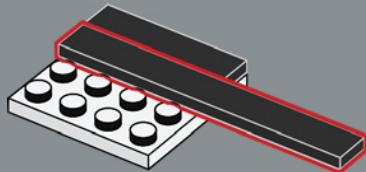

117

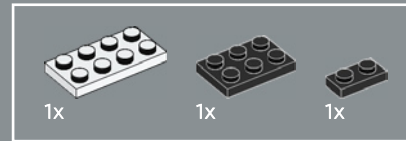
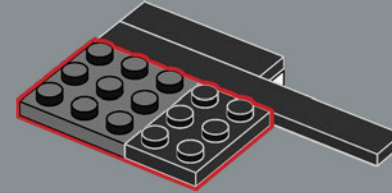

118

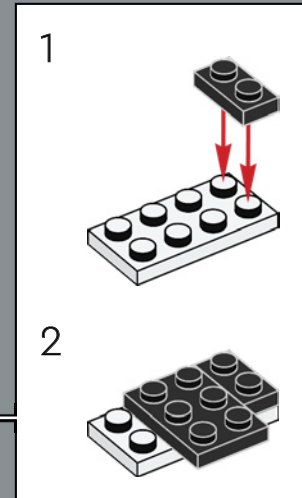
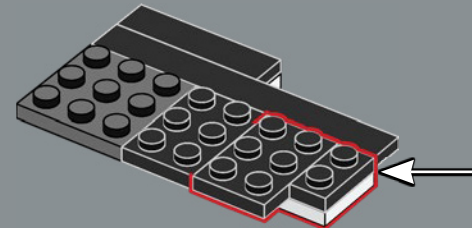

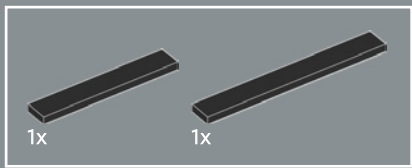

119

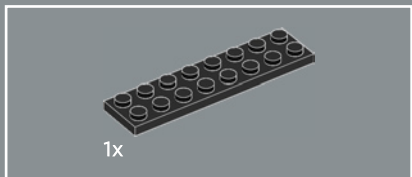
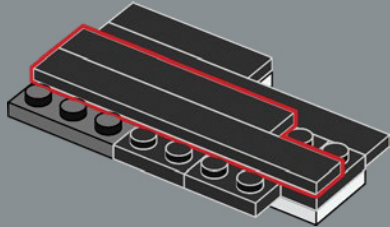

120

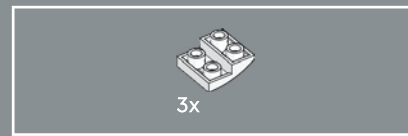
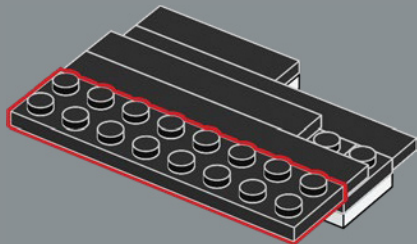

121

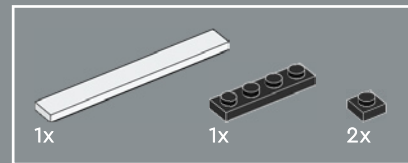
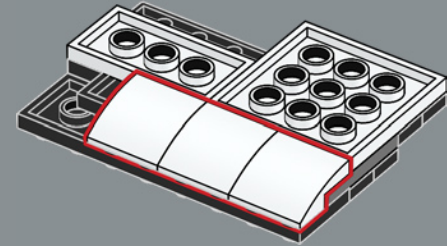

122

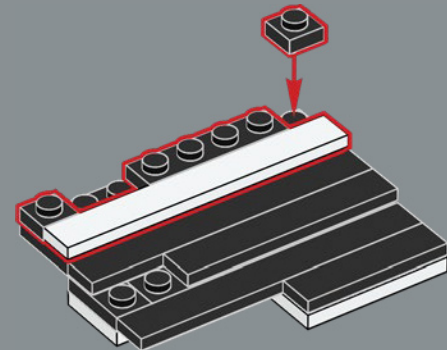



123

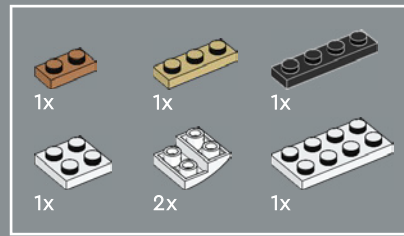
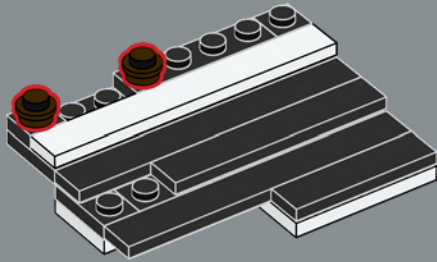

124

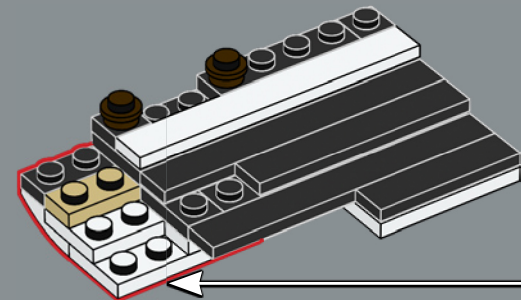
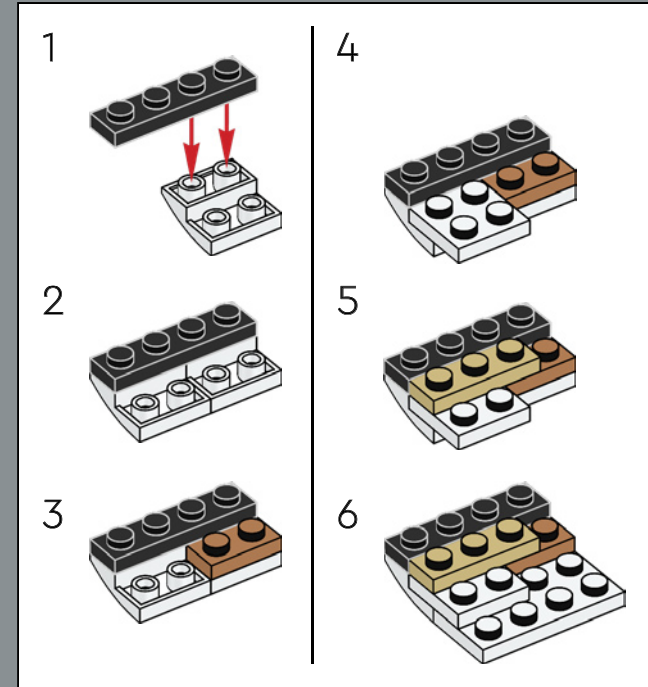

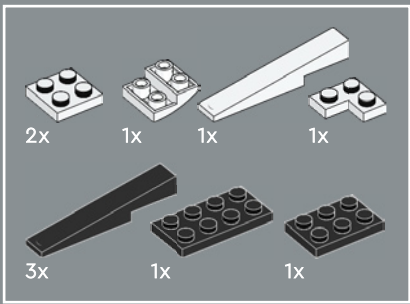

125

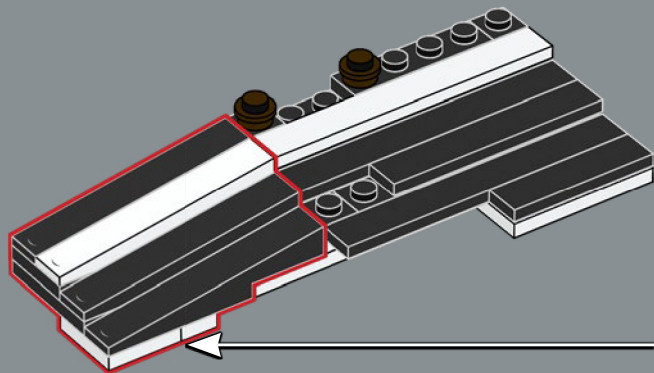
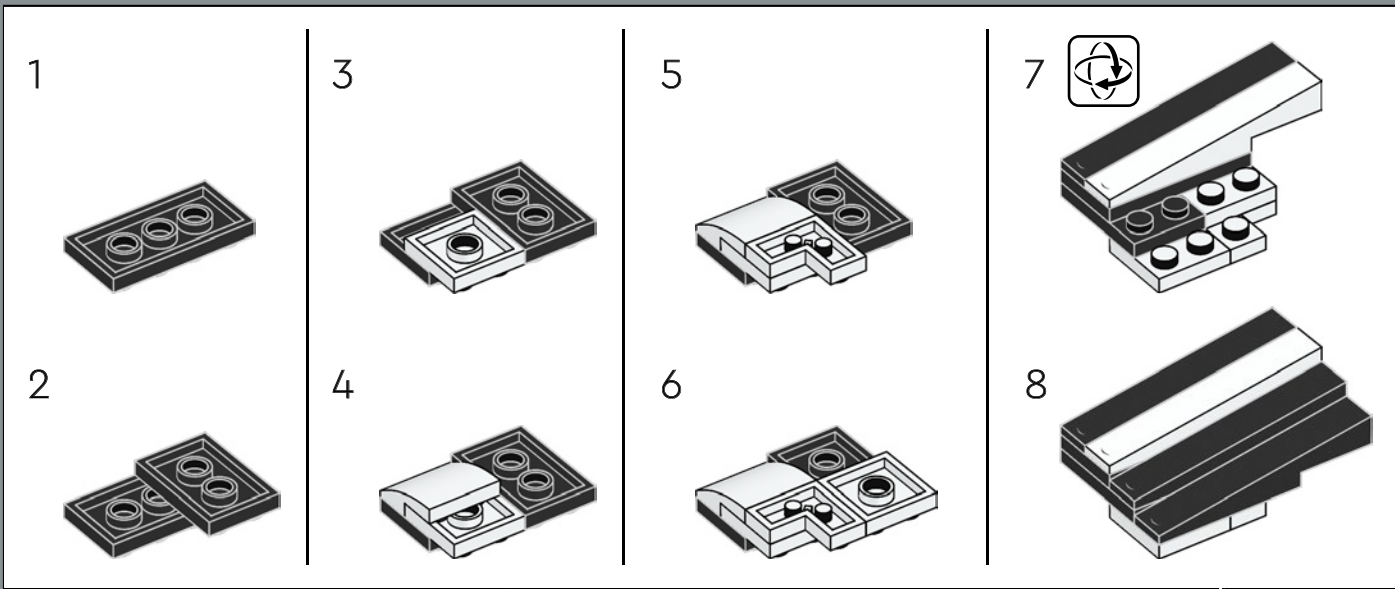

126

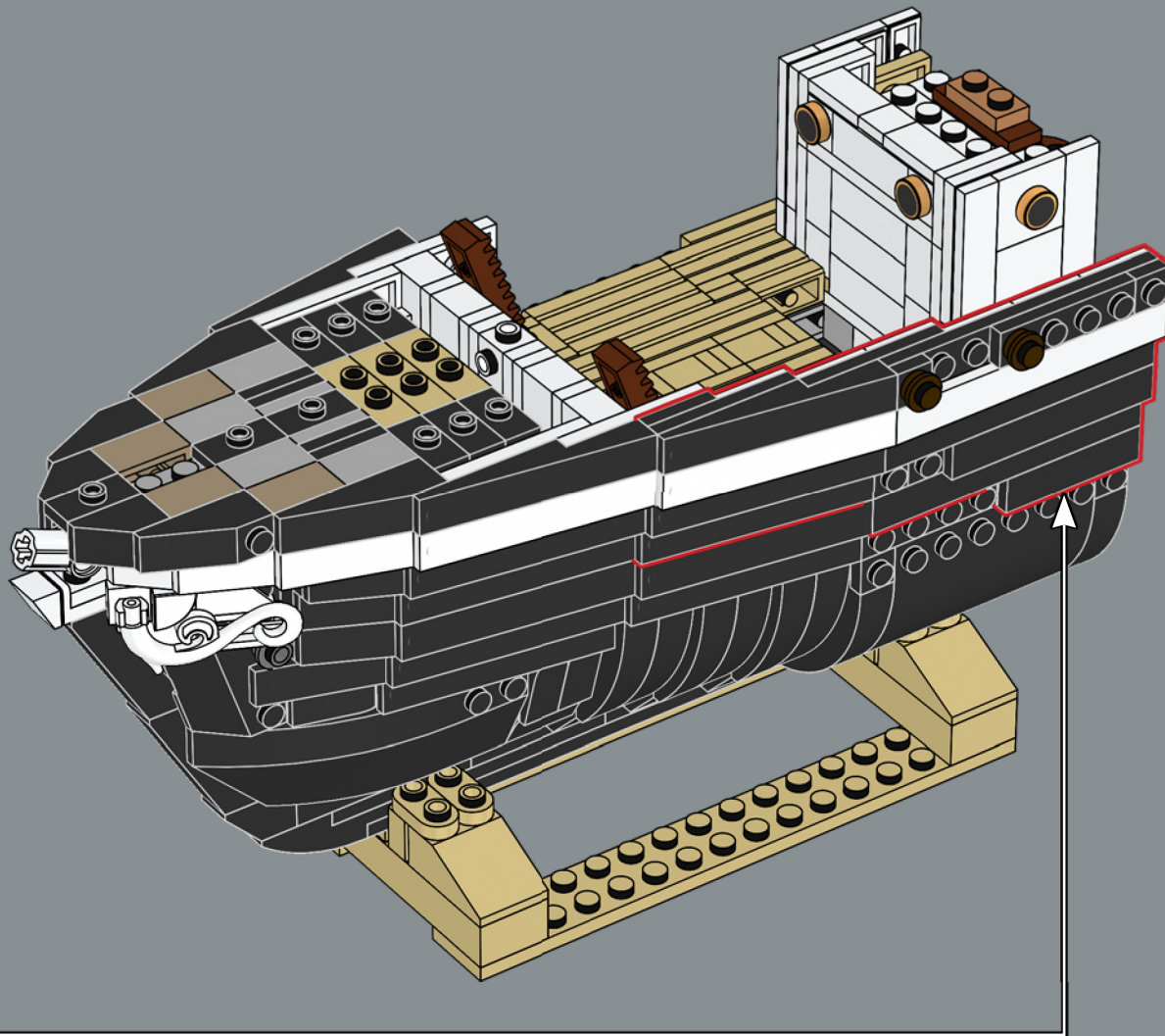

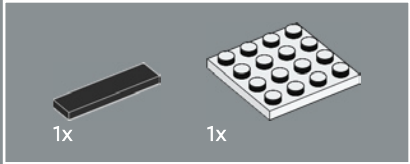
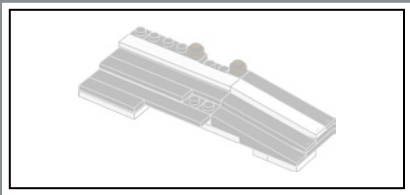

127

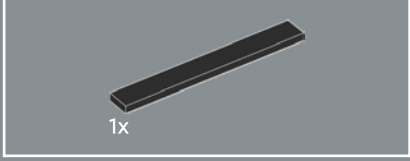
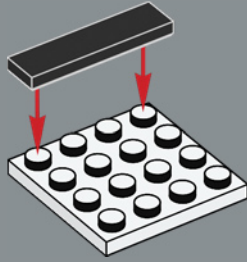

128

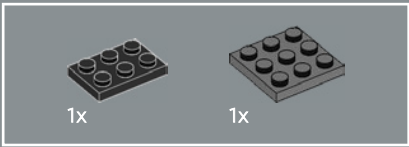
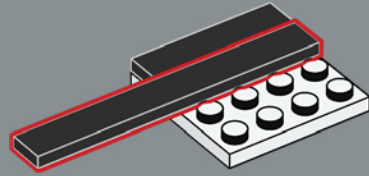

129

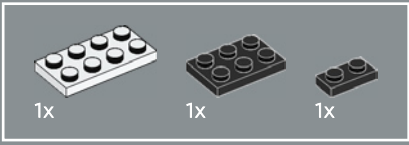
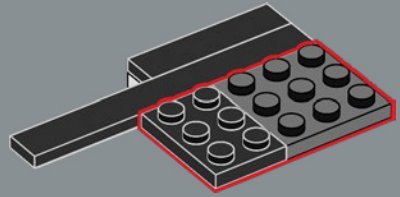

130

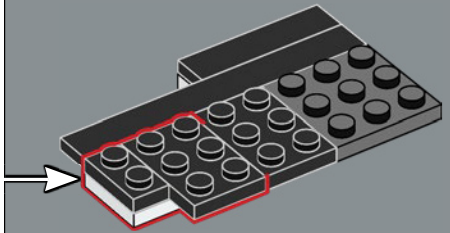
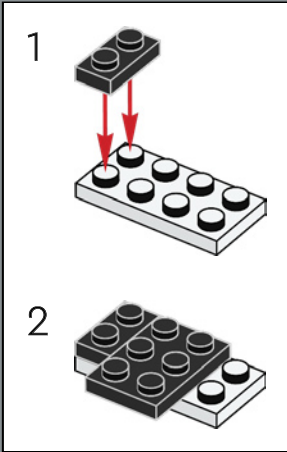

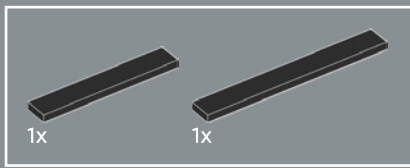

131

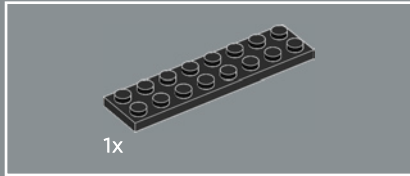
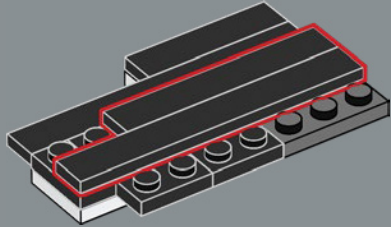

132

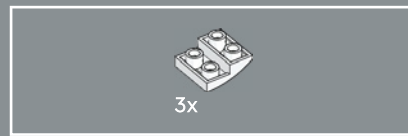
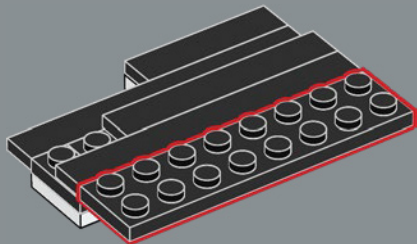

133

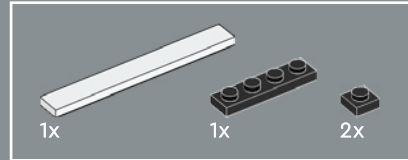
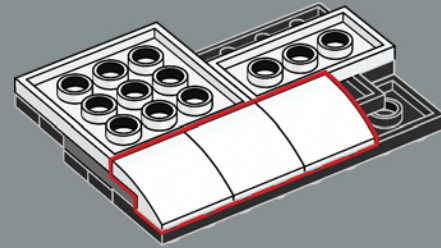

134

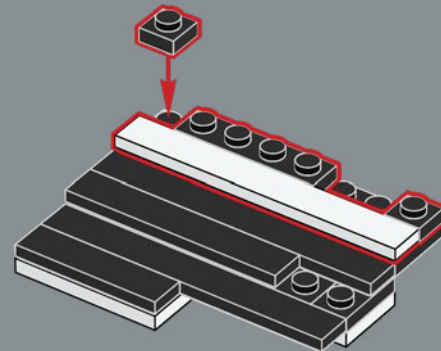

2x

135

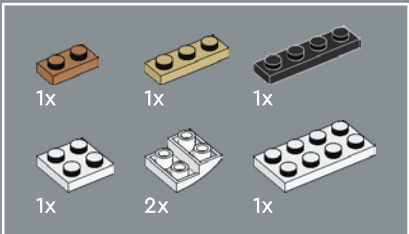
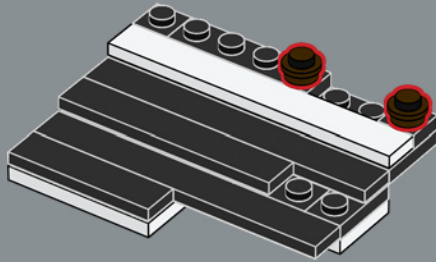

136

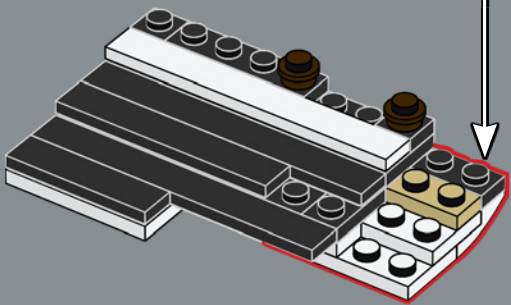
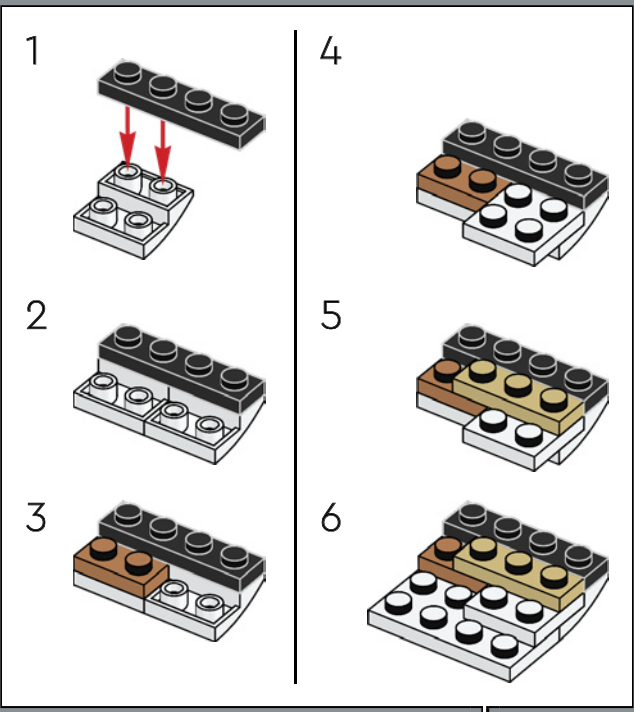

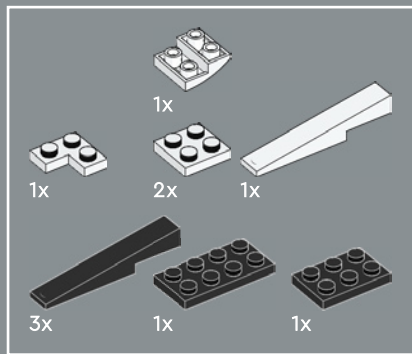

137

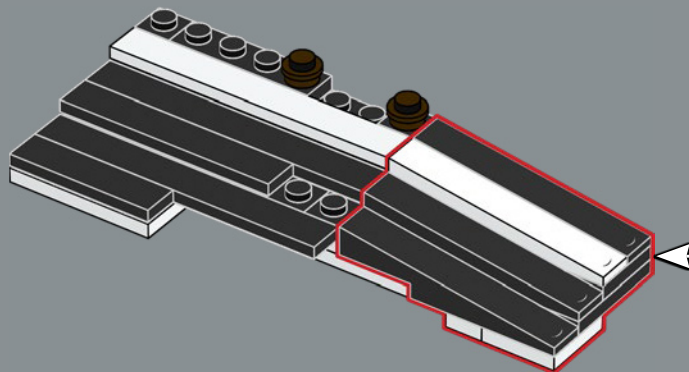
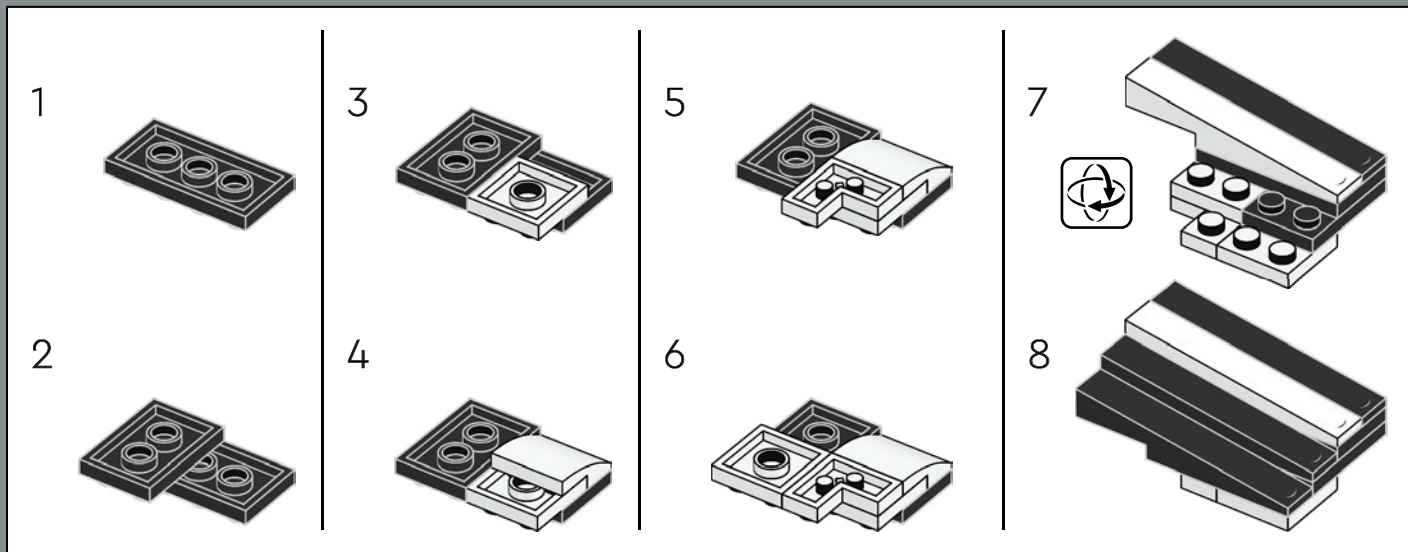

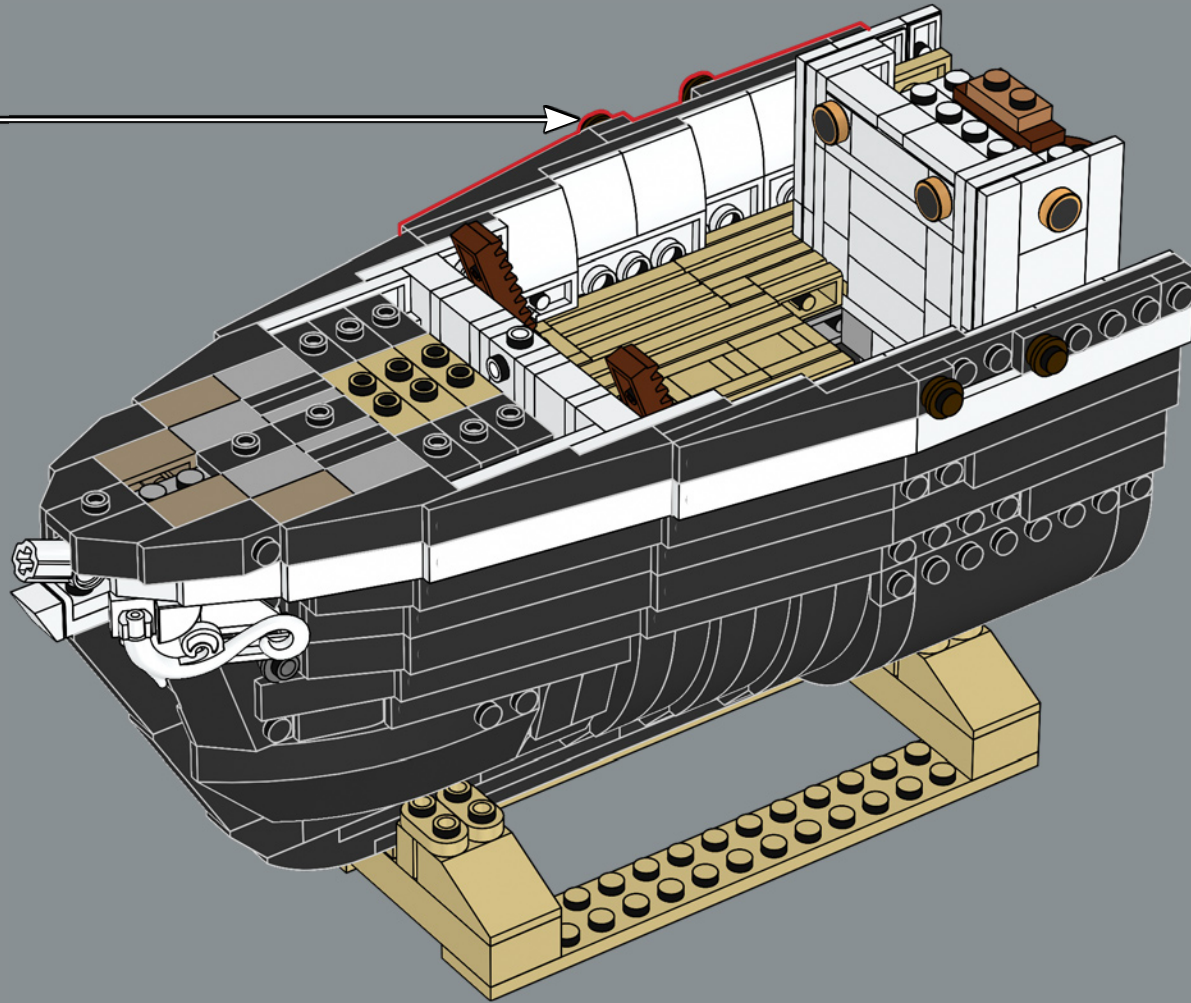

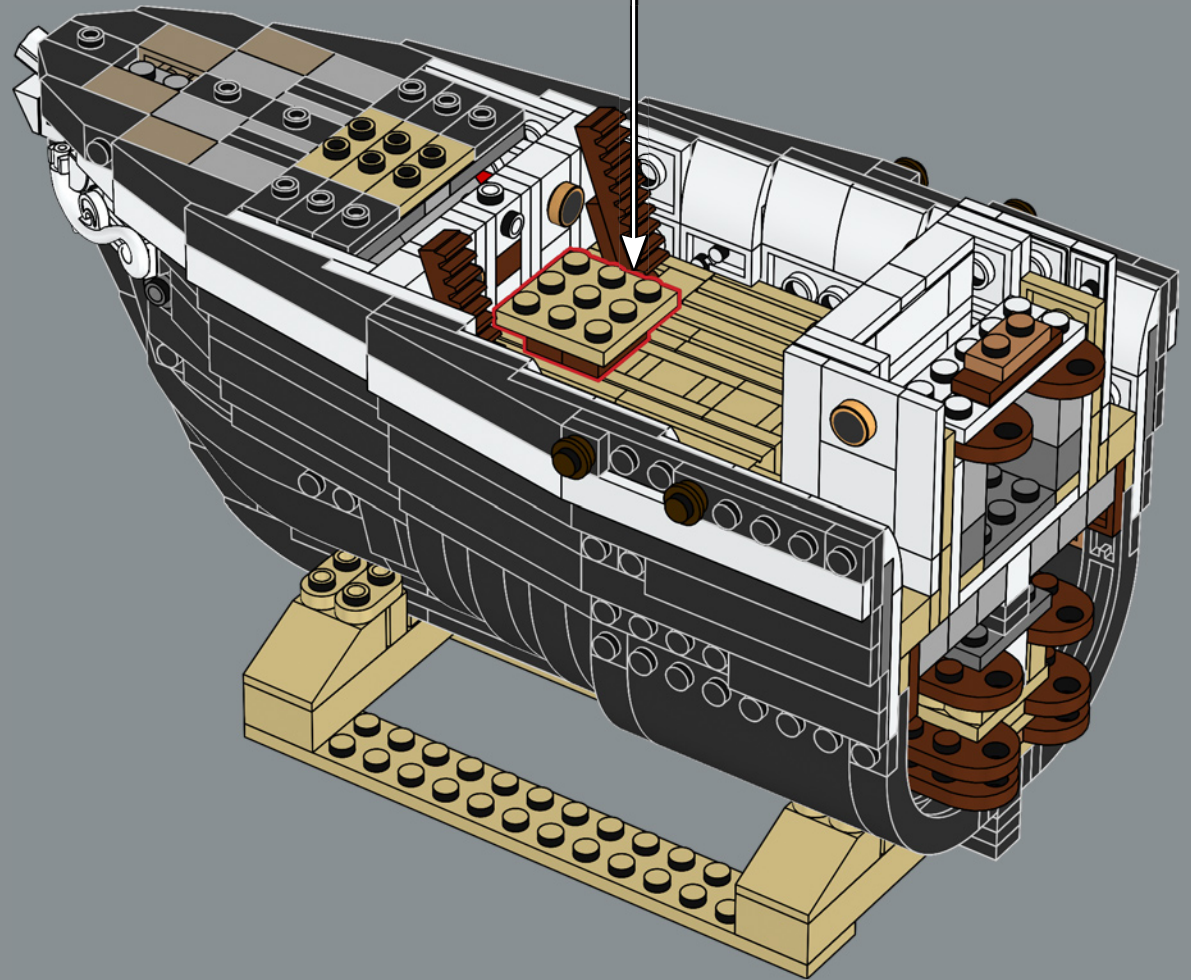
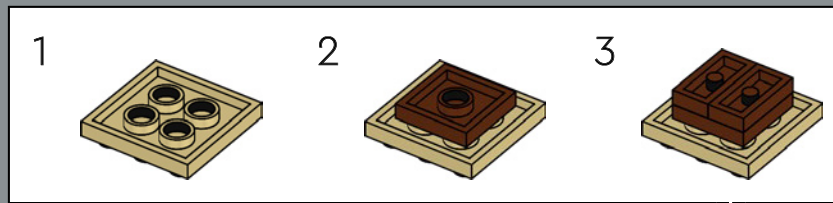
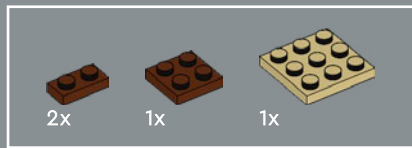

139

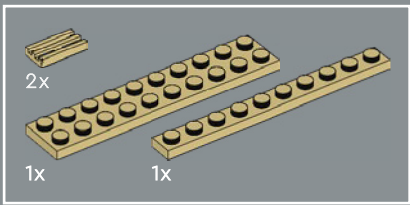

140

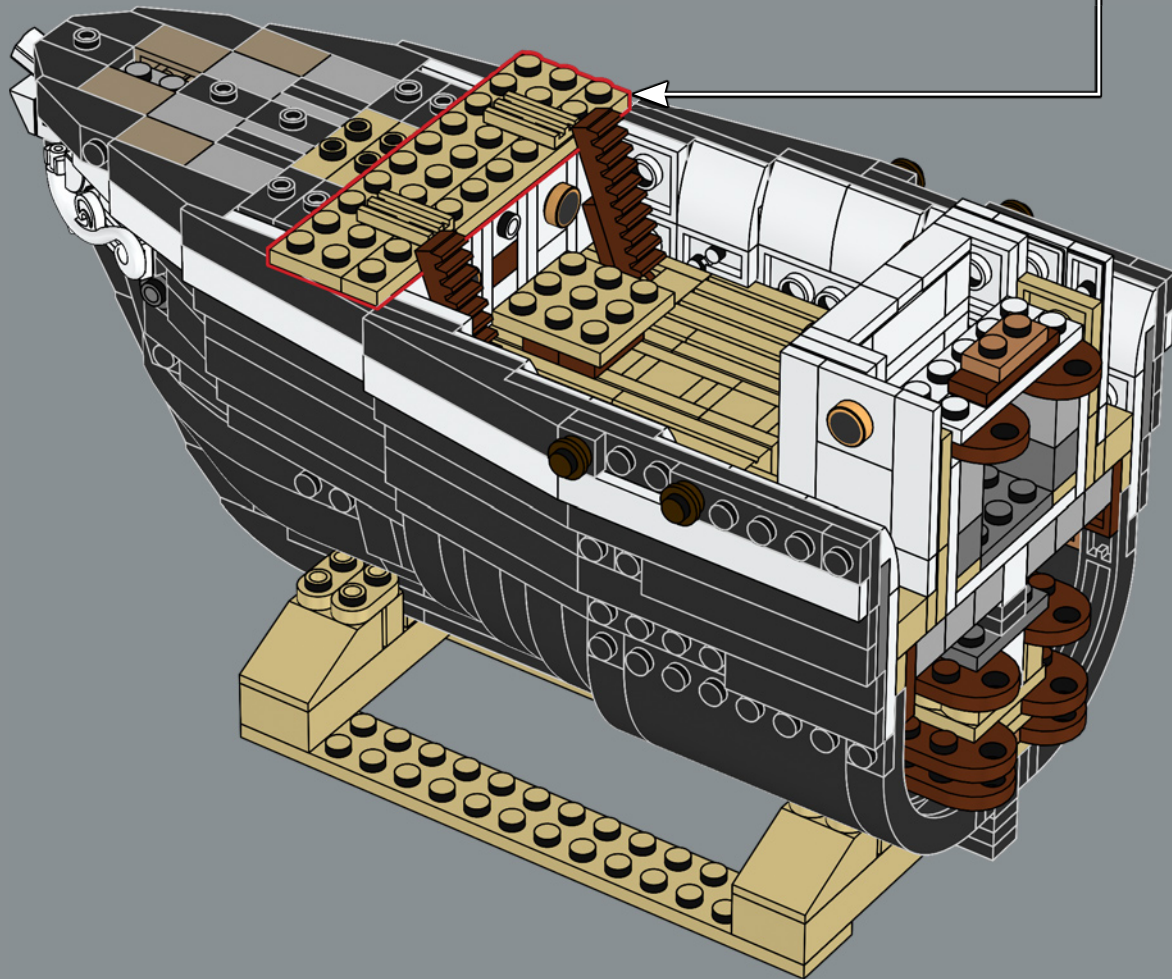
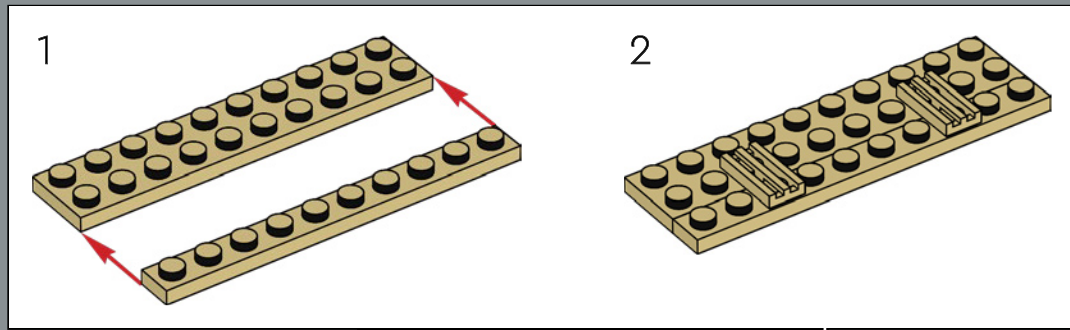

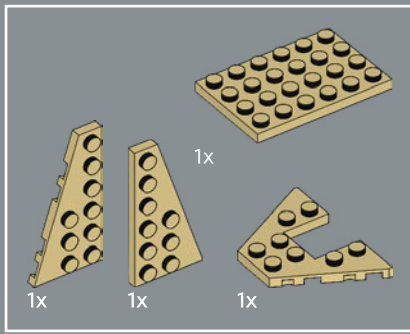

141

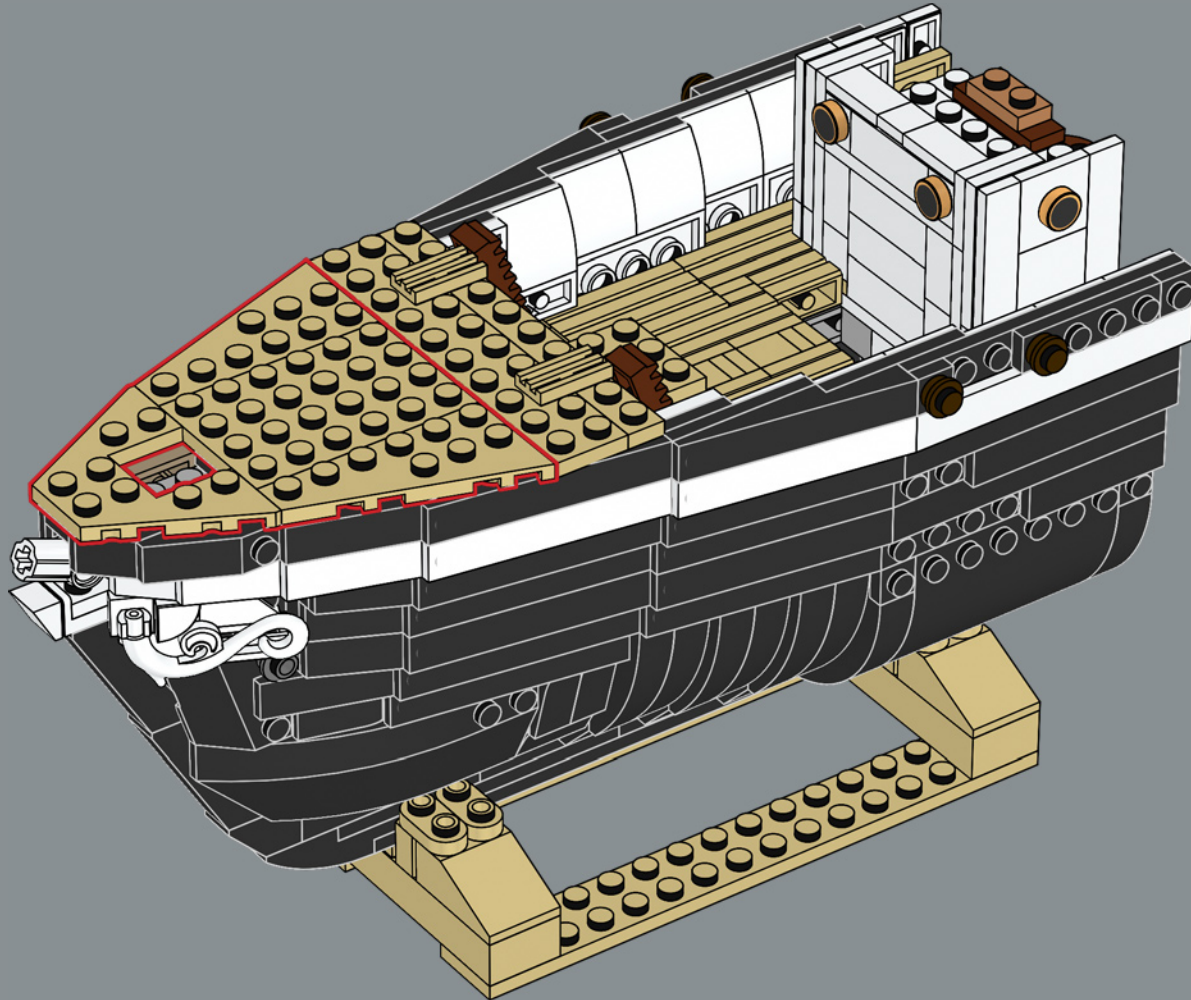

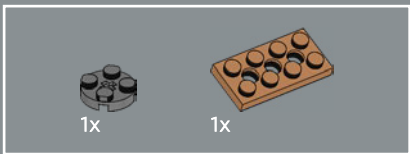

142

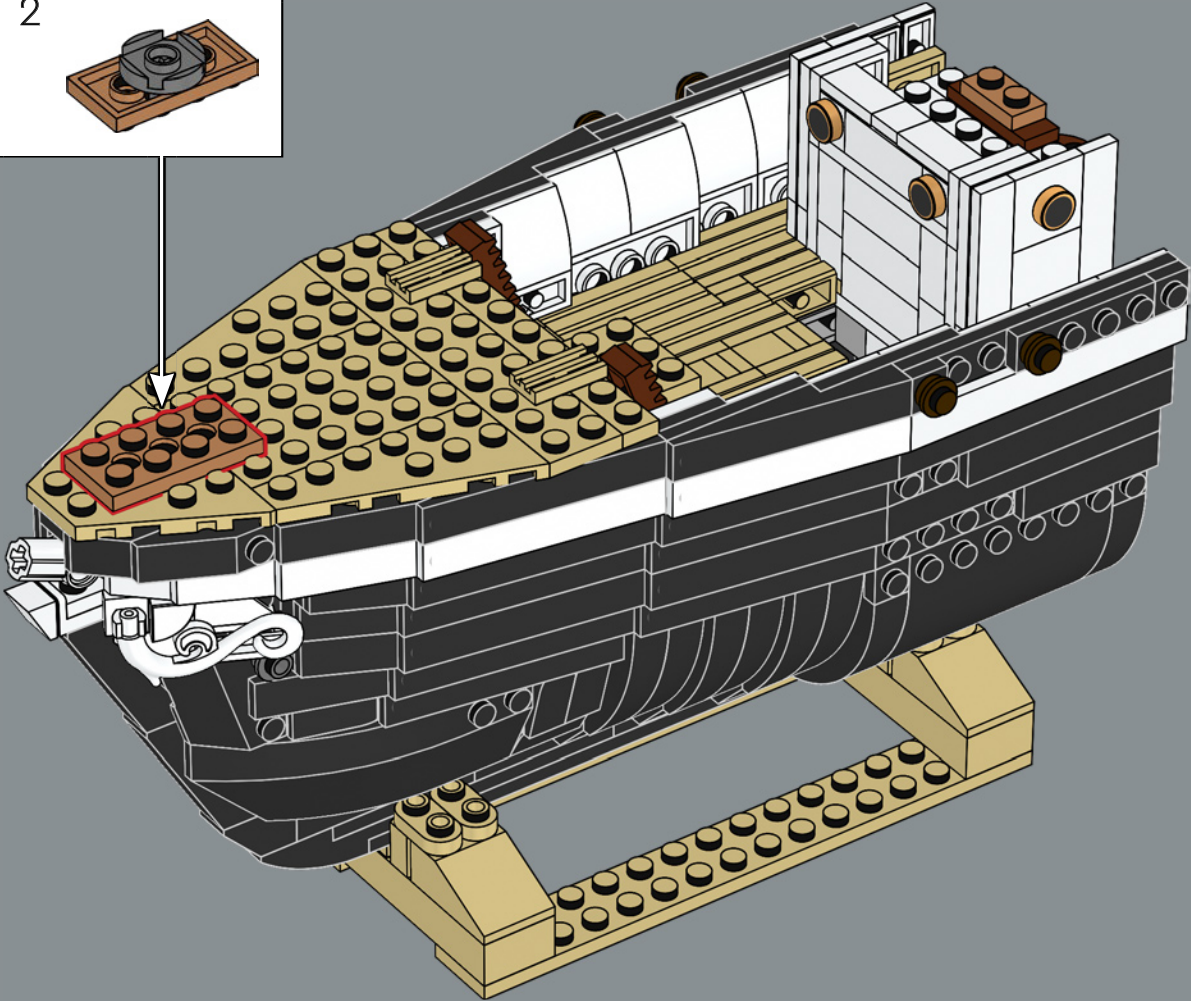
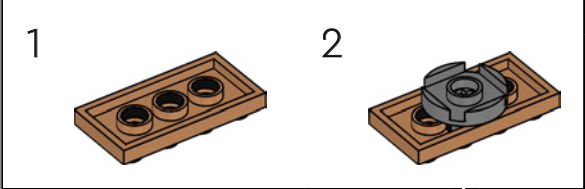

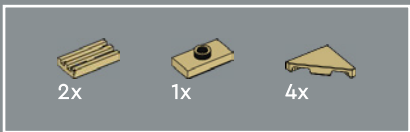

143

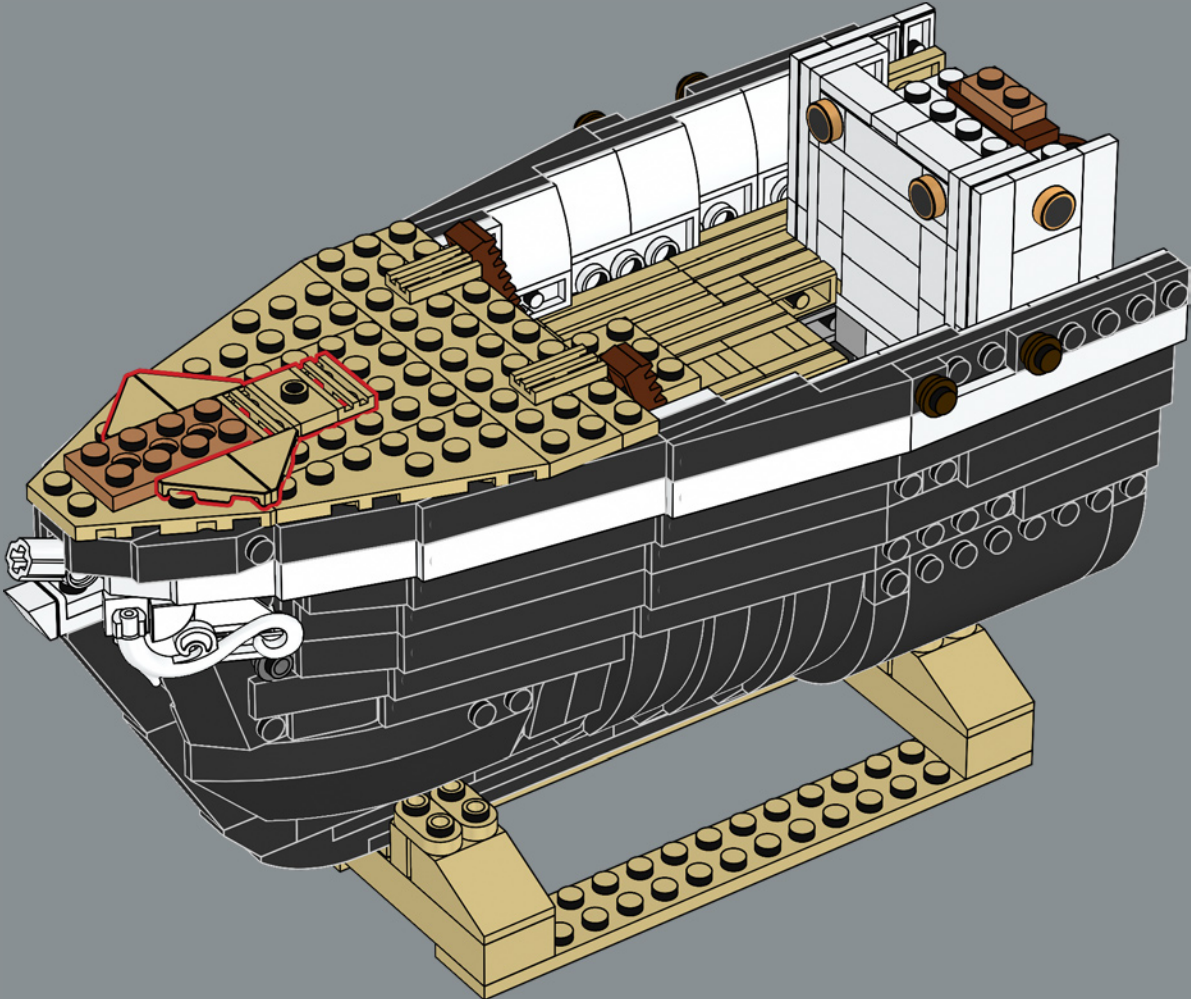



144

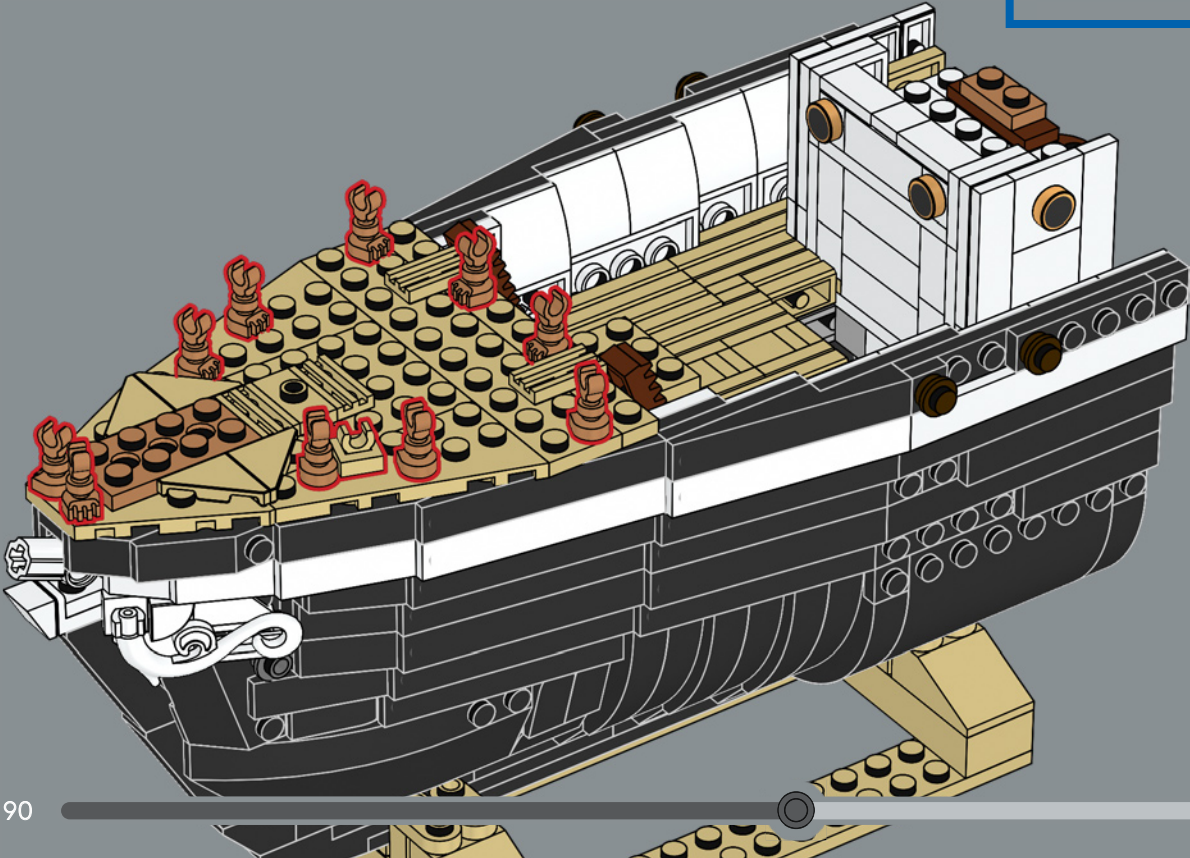
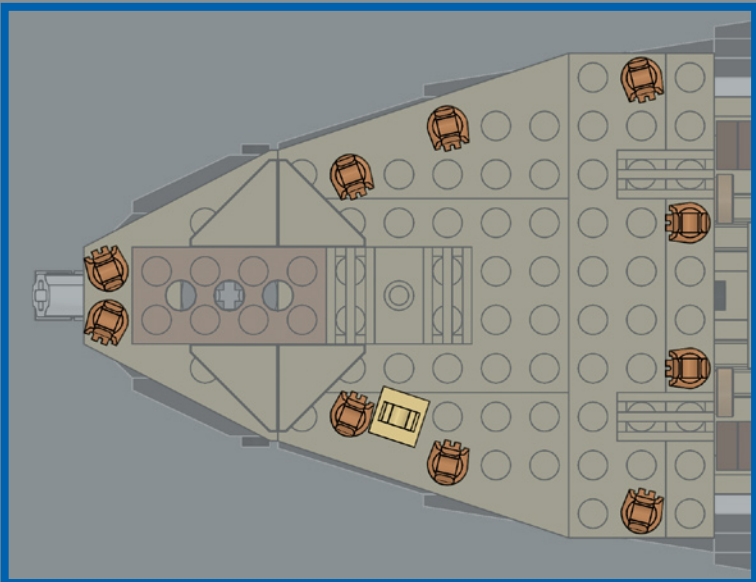



145

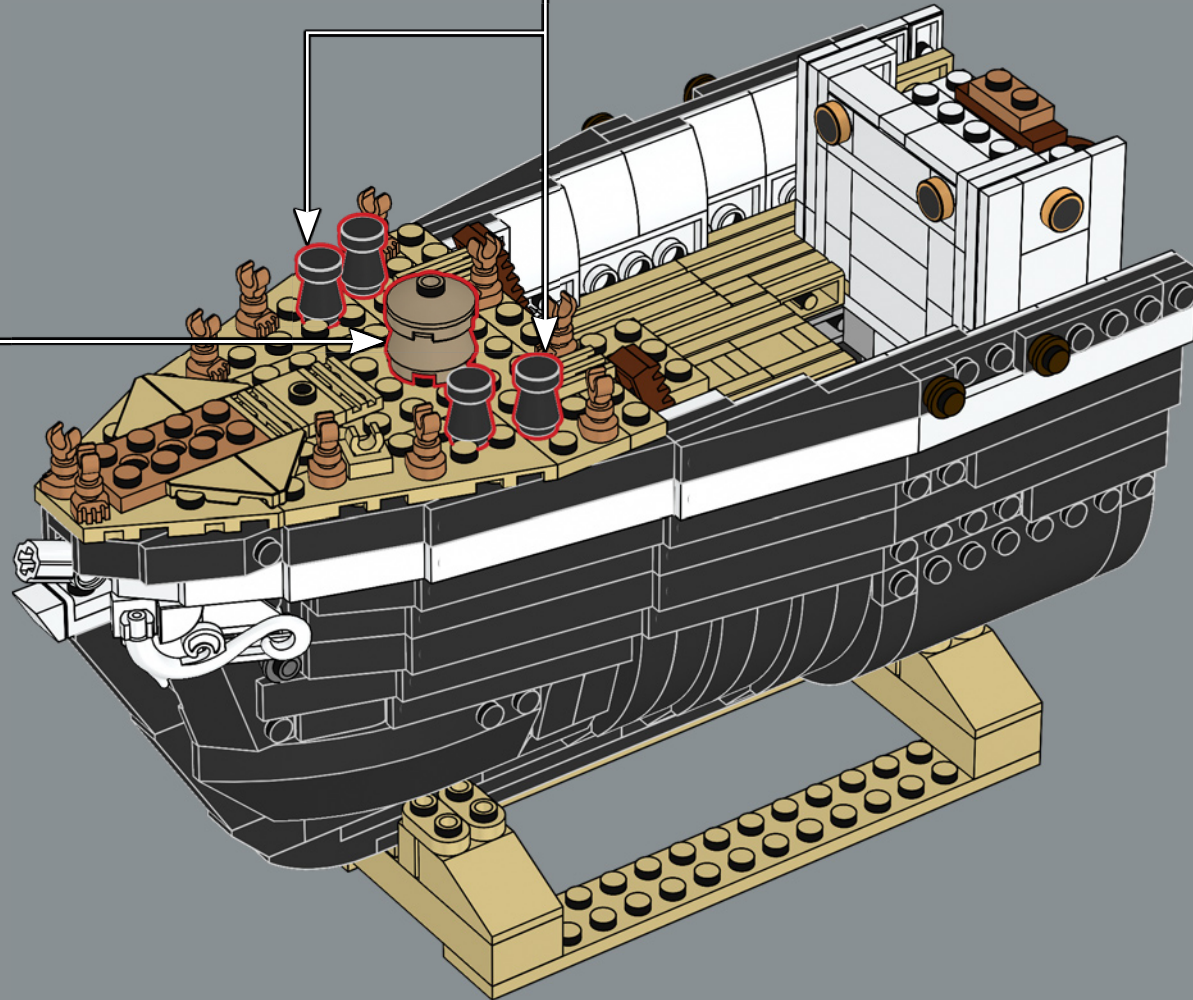
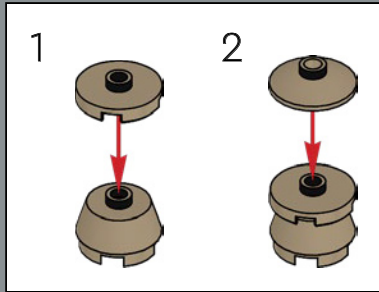
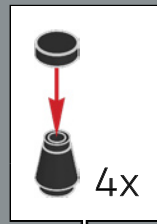

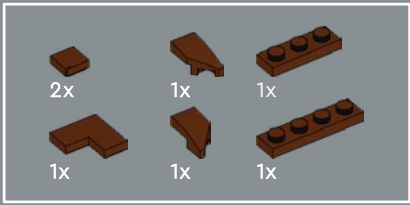

146

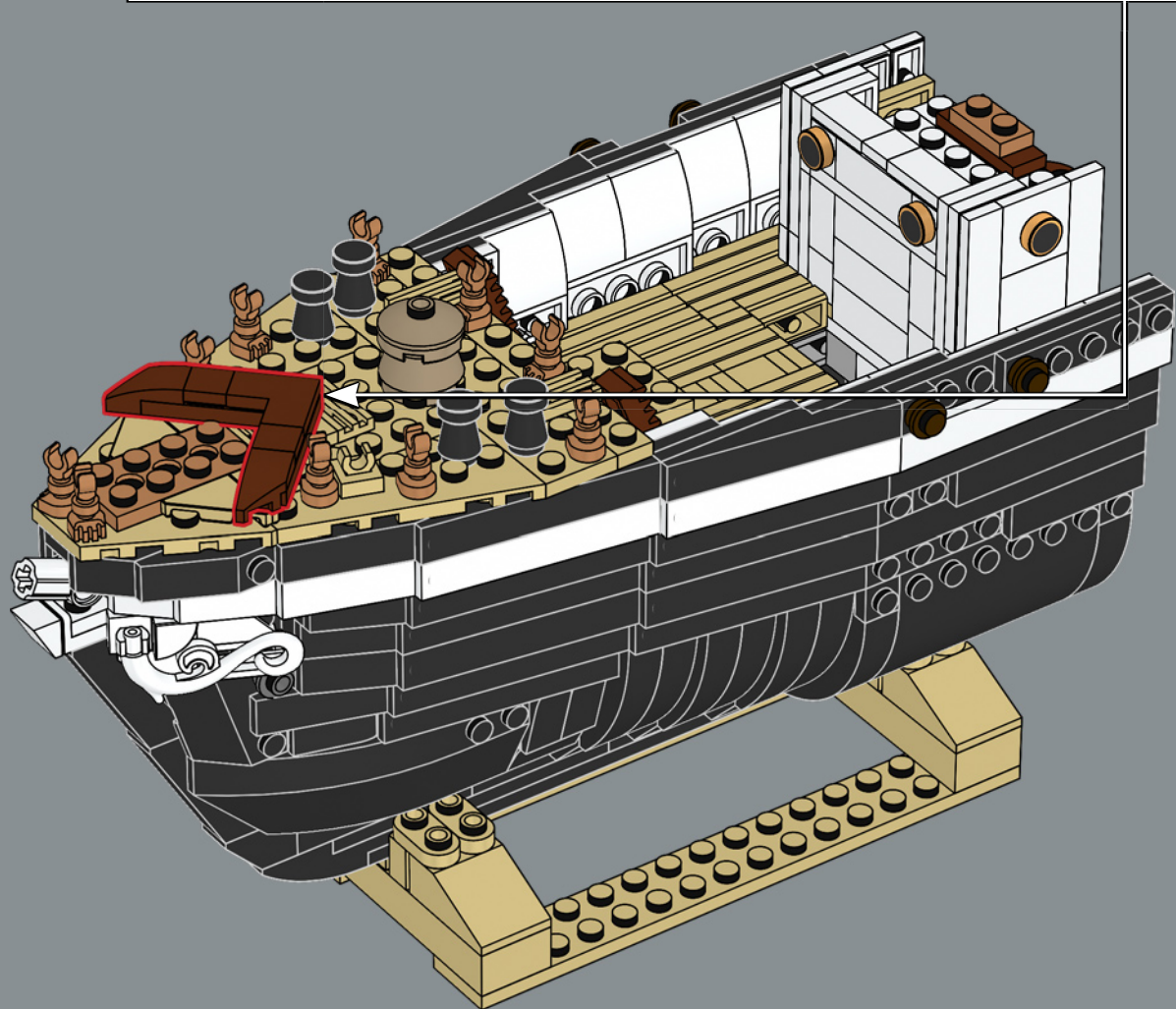
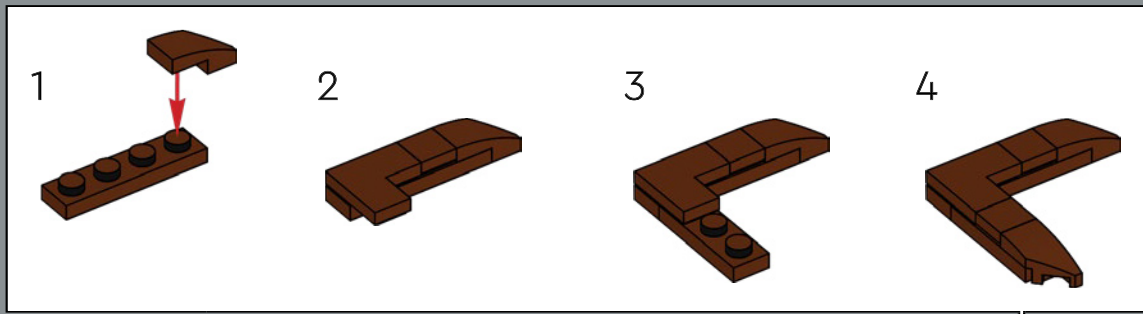

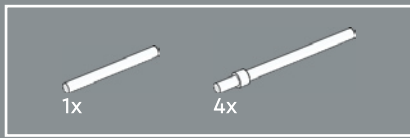

147

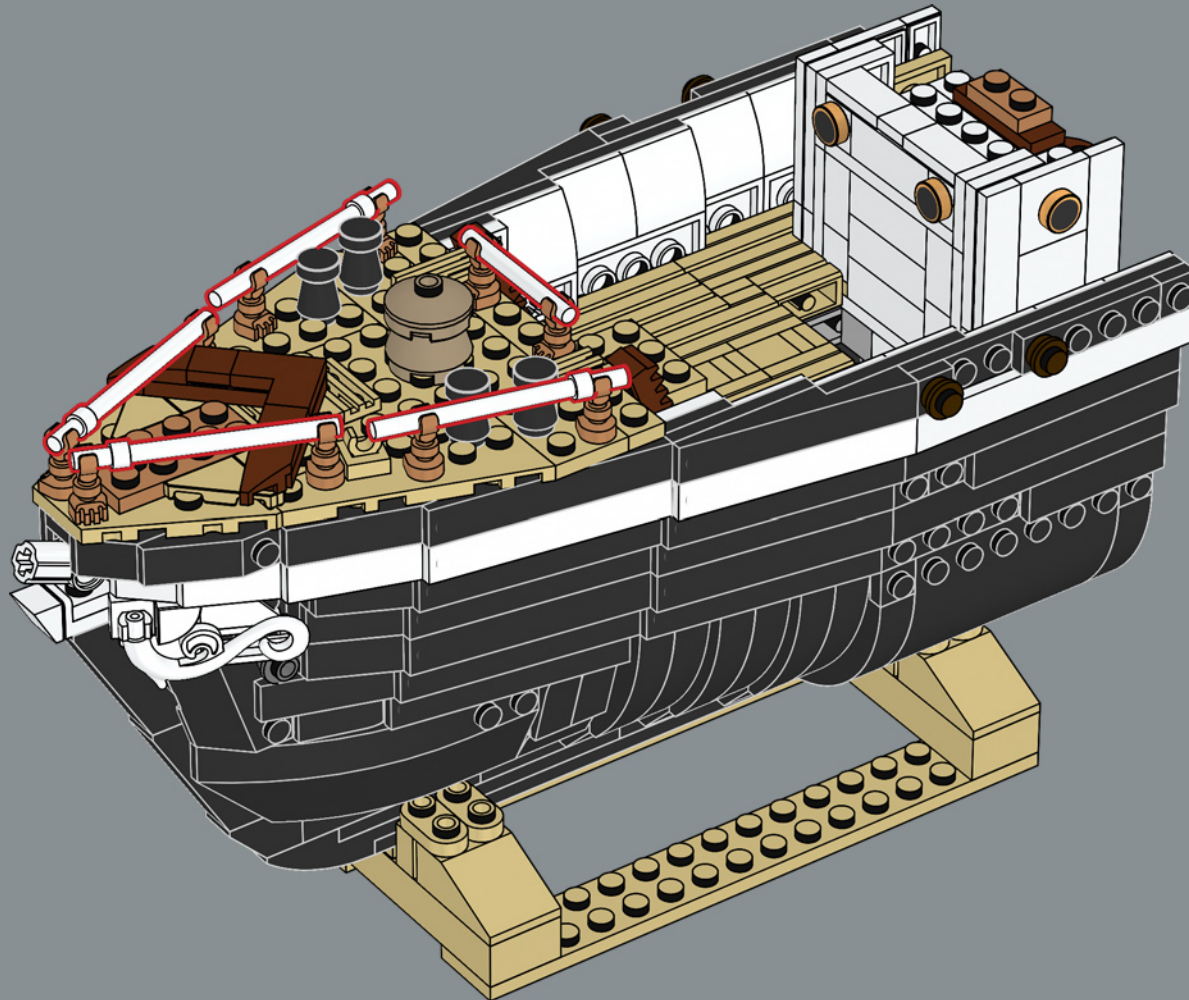



148

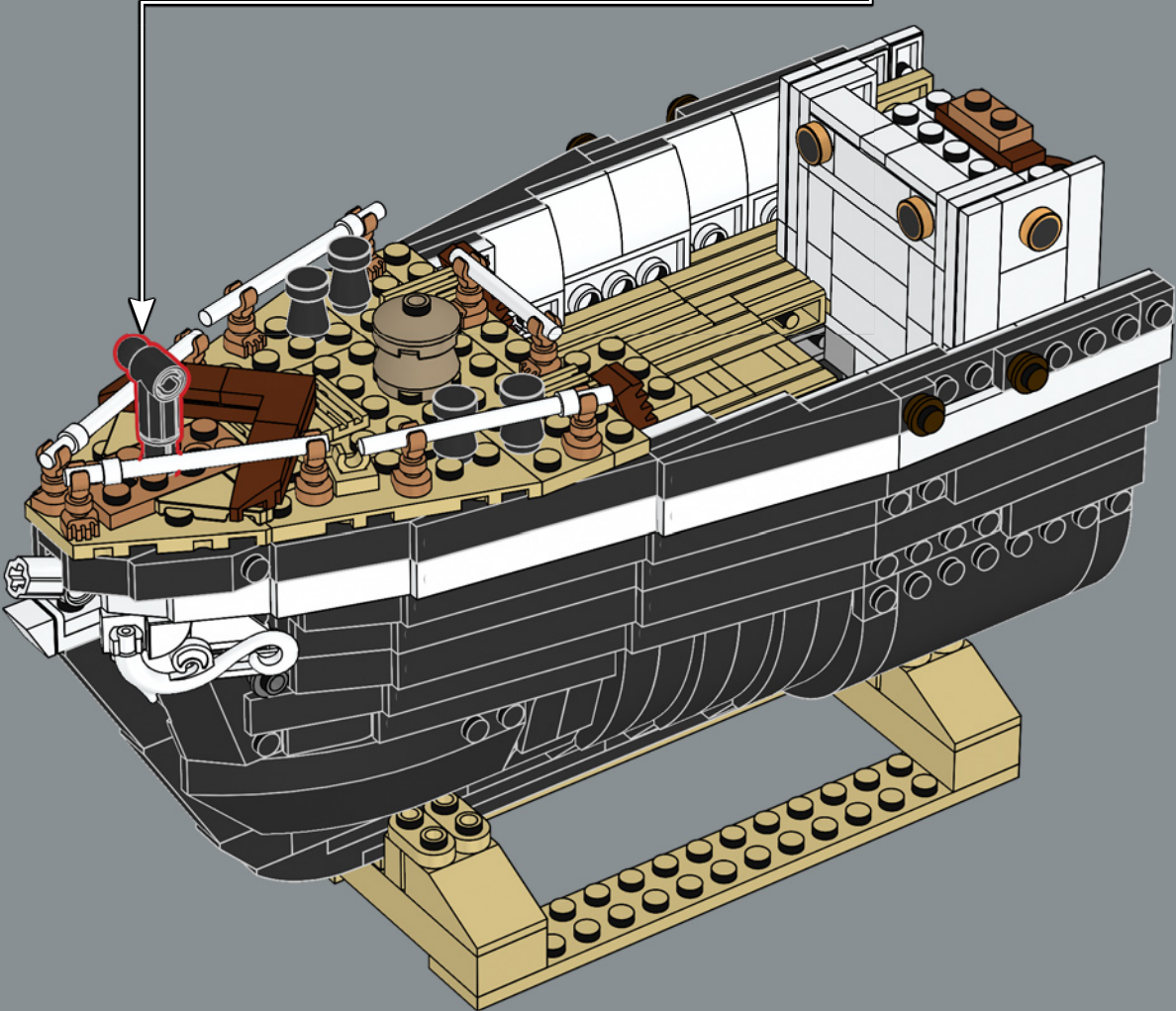
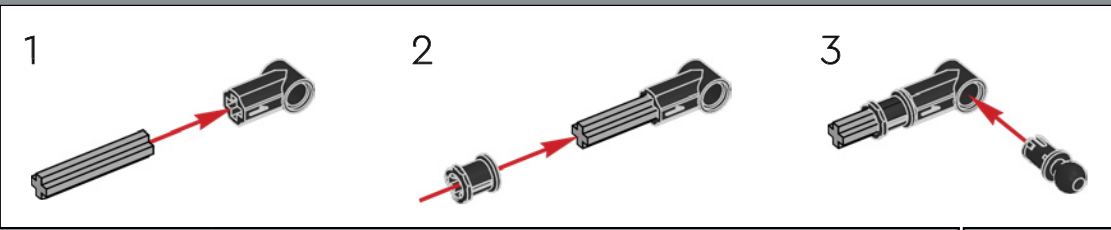

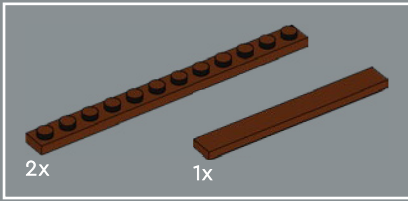
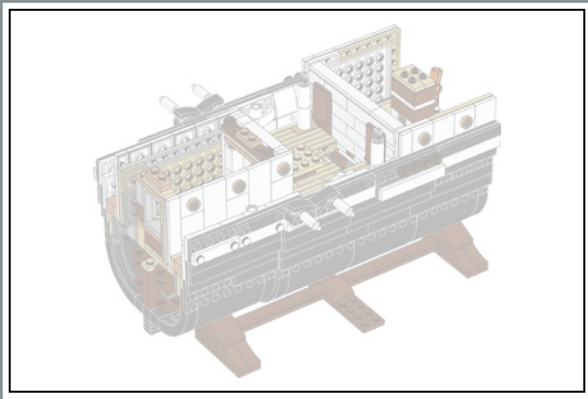

149

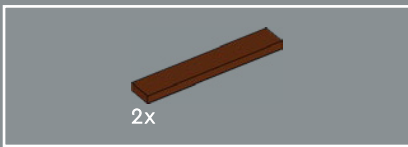
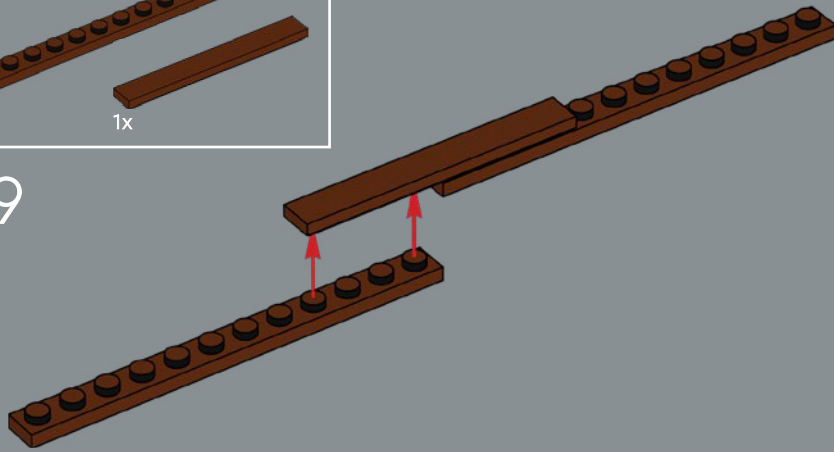

150

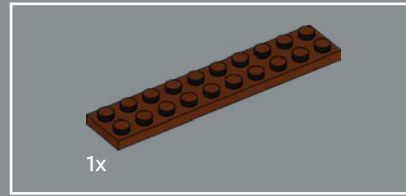
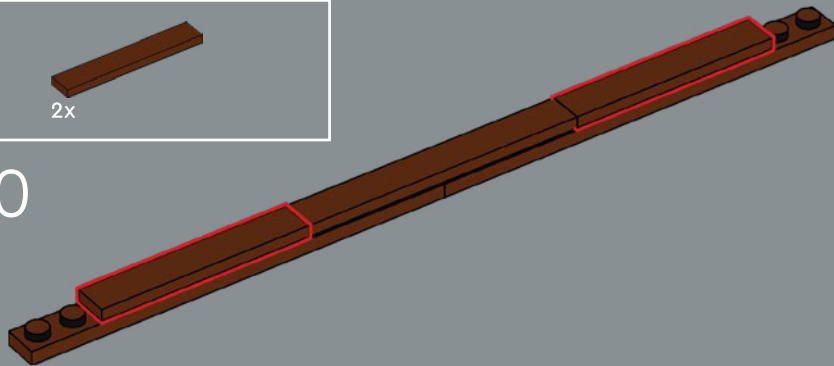

151

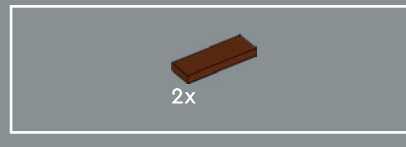
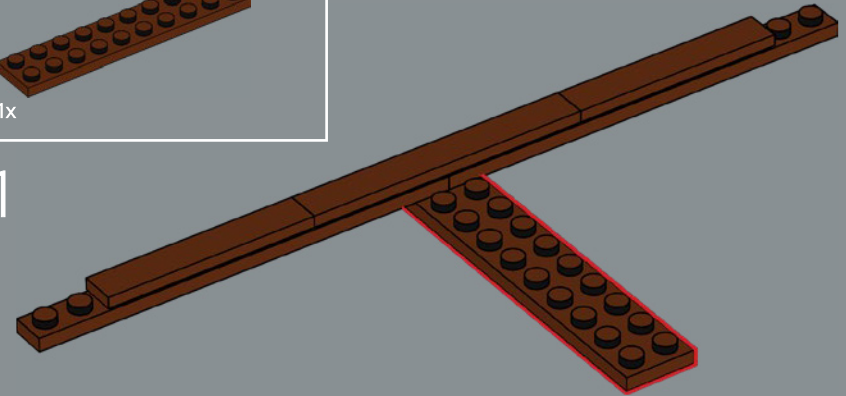

152

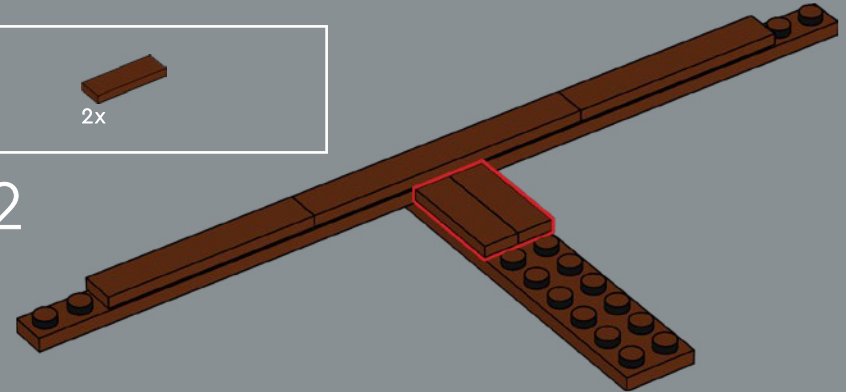

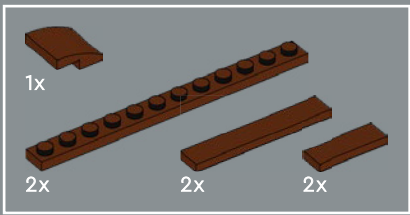

153

1

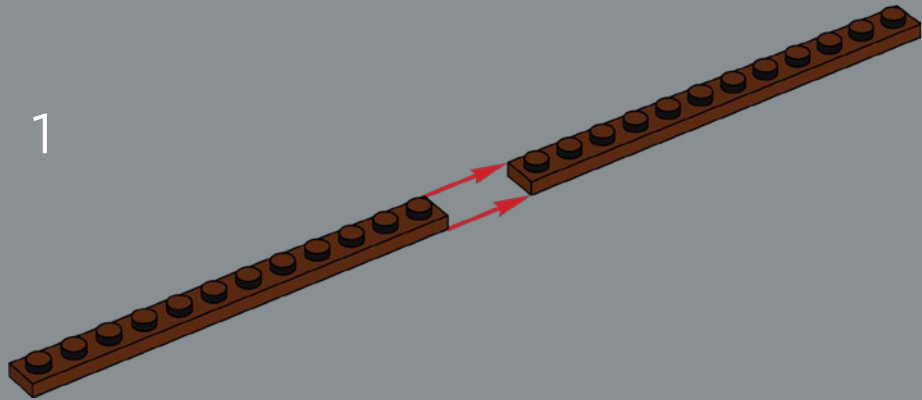

2

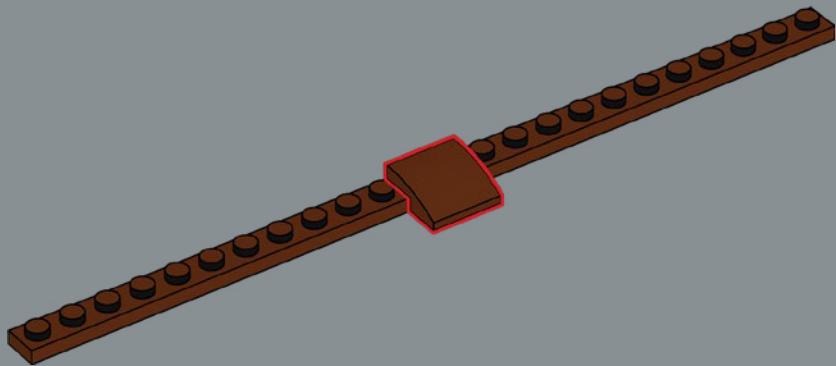

3

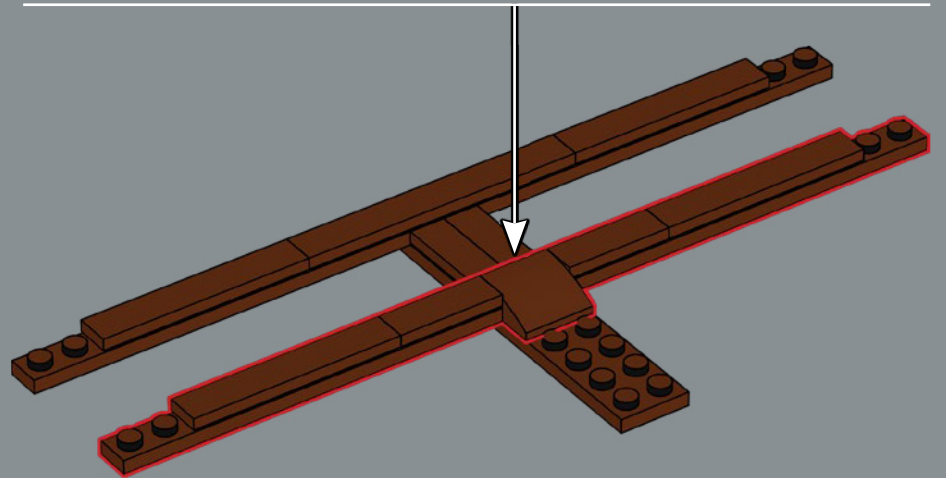
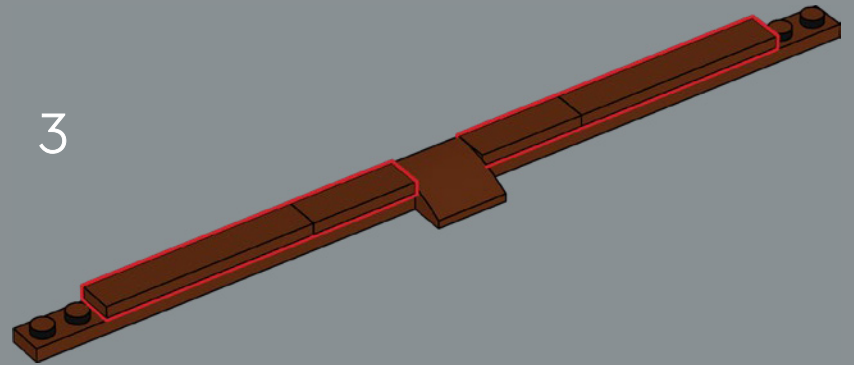

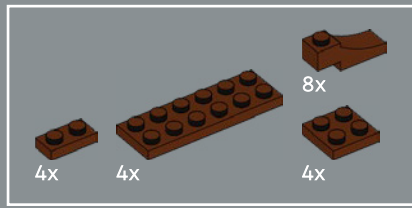

154

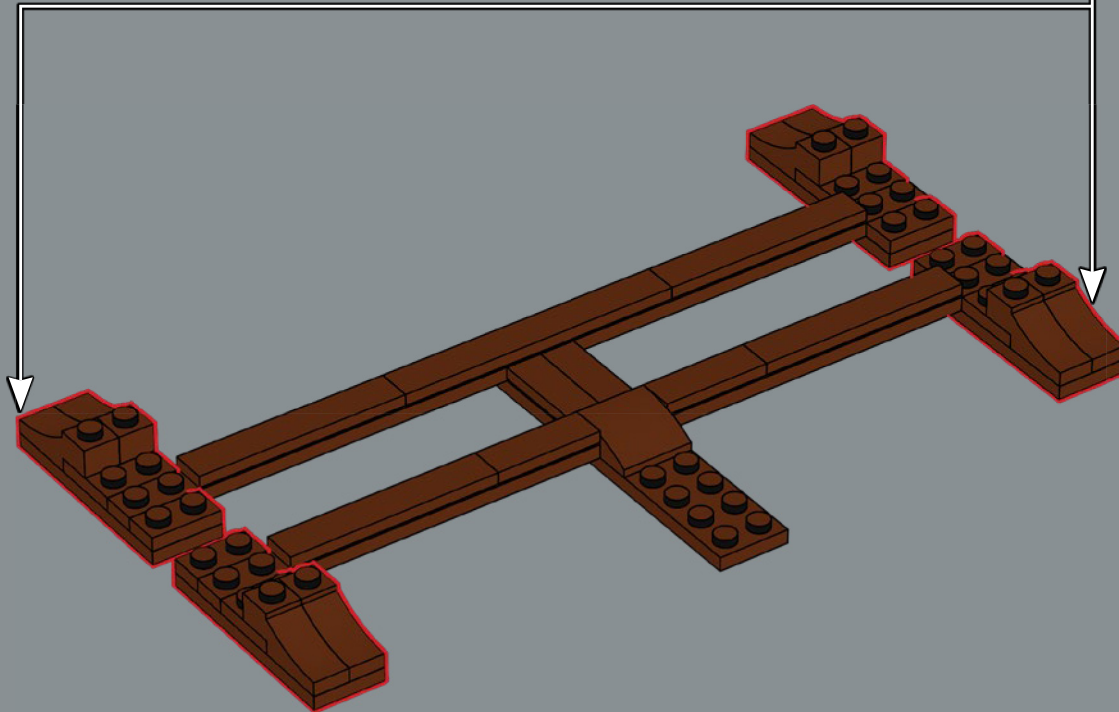
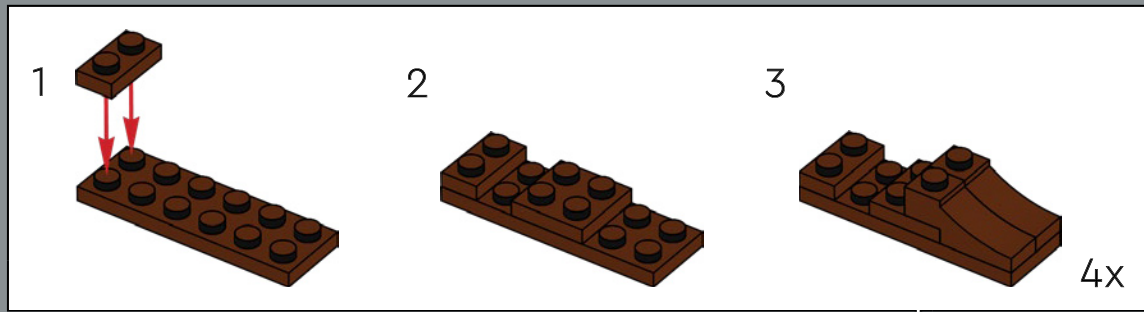

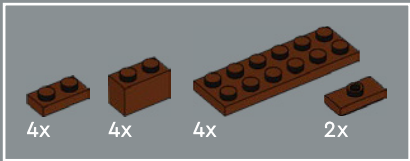

155

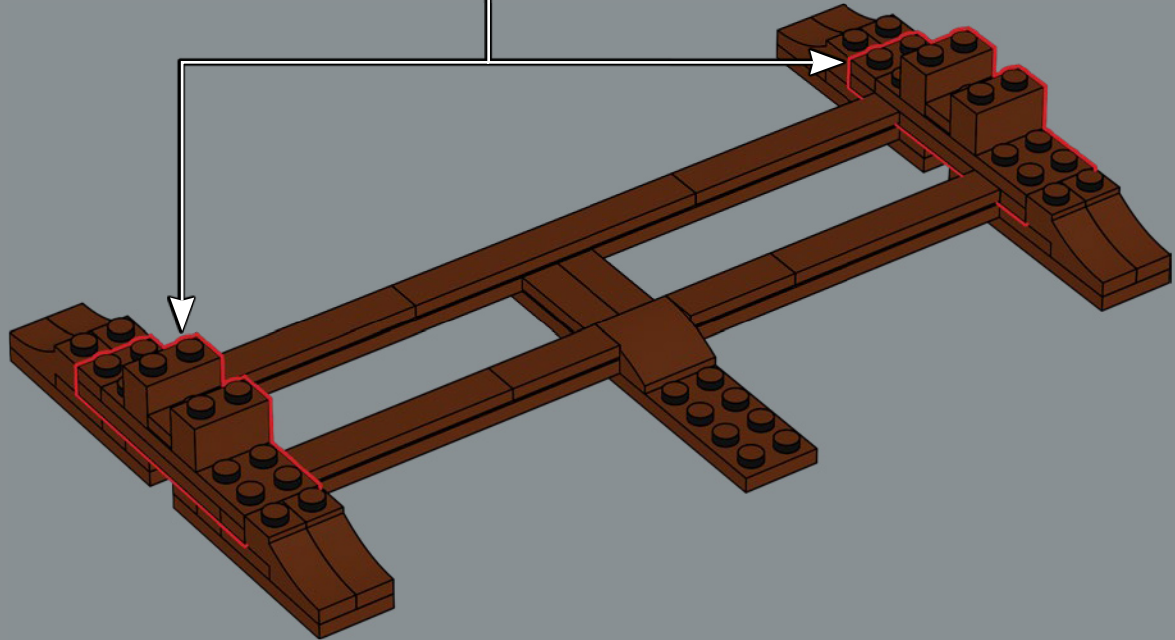
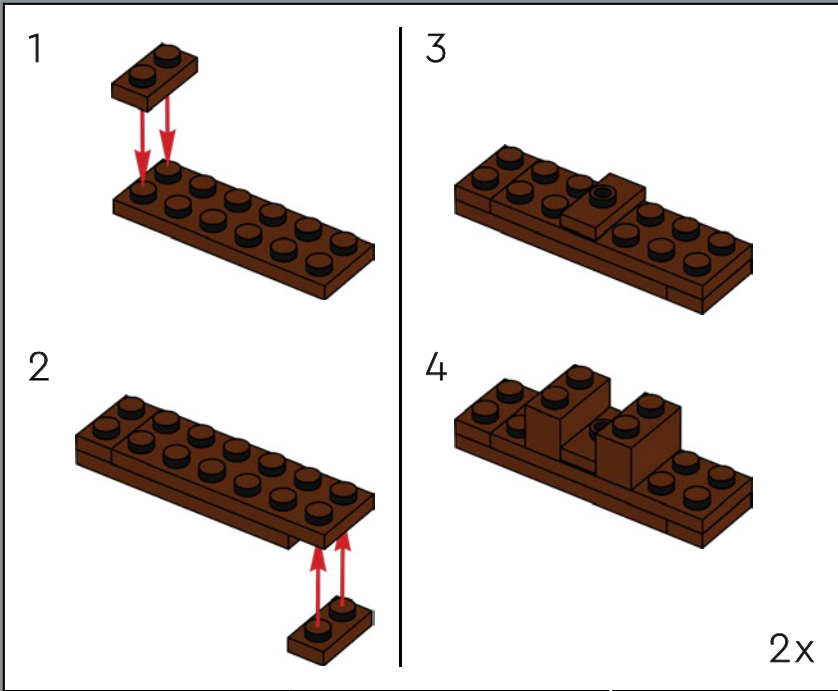



156

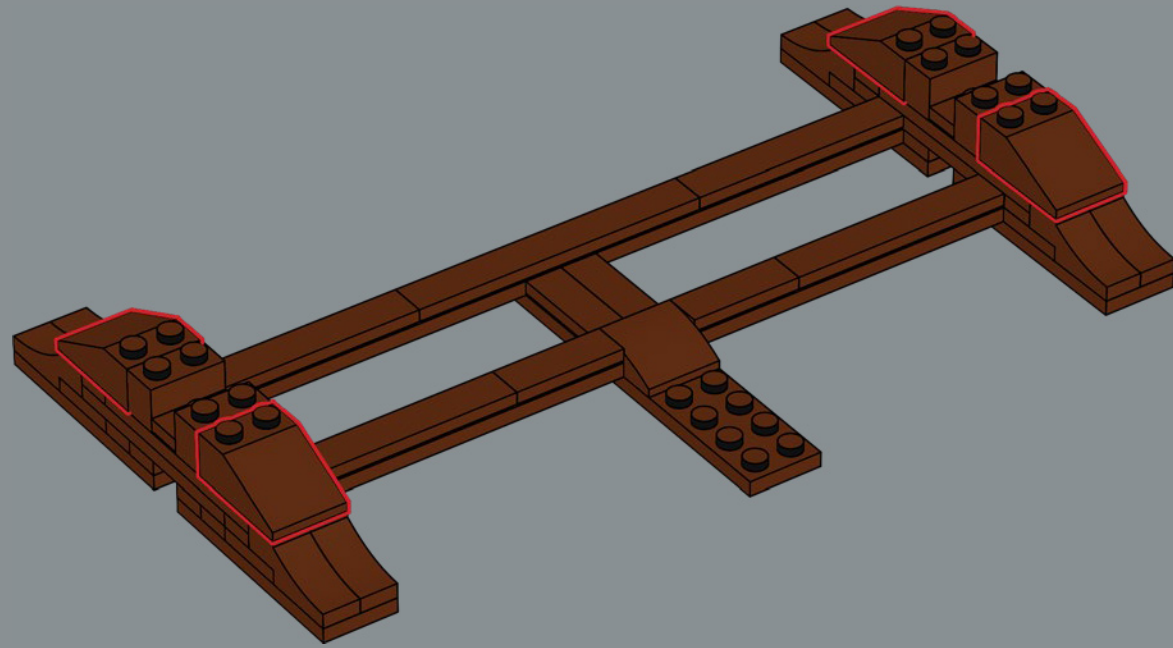

157

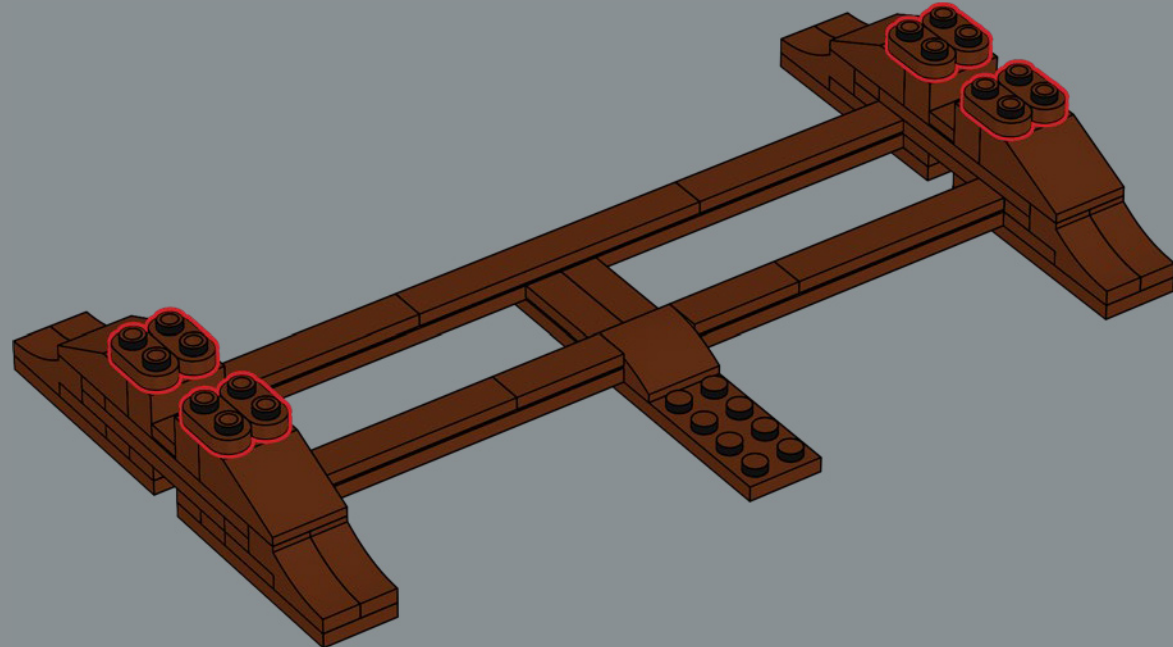

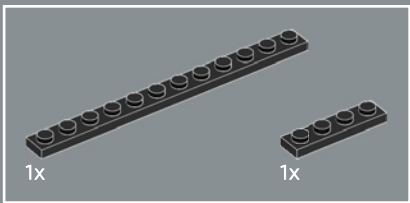
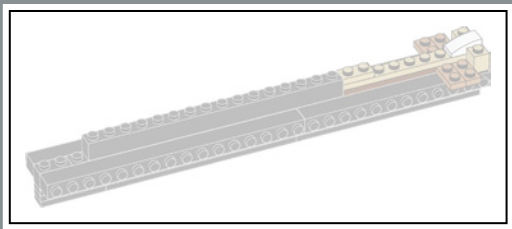

158

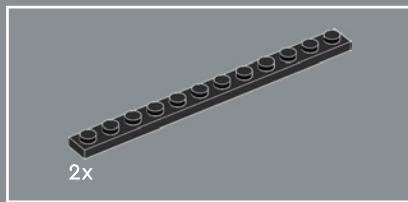
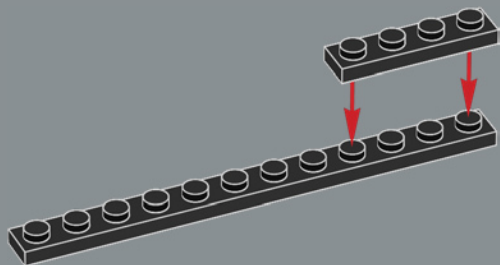

159

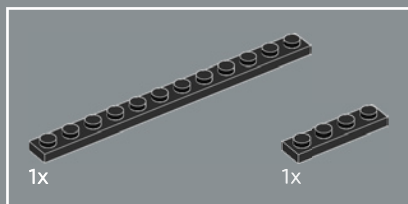
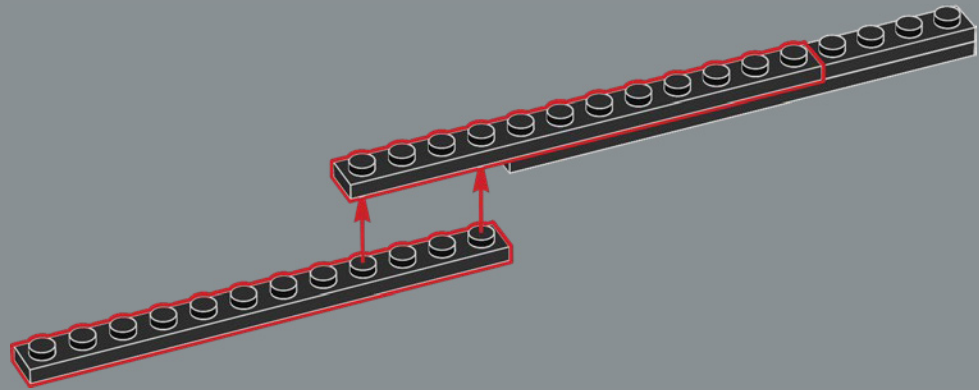

160

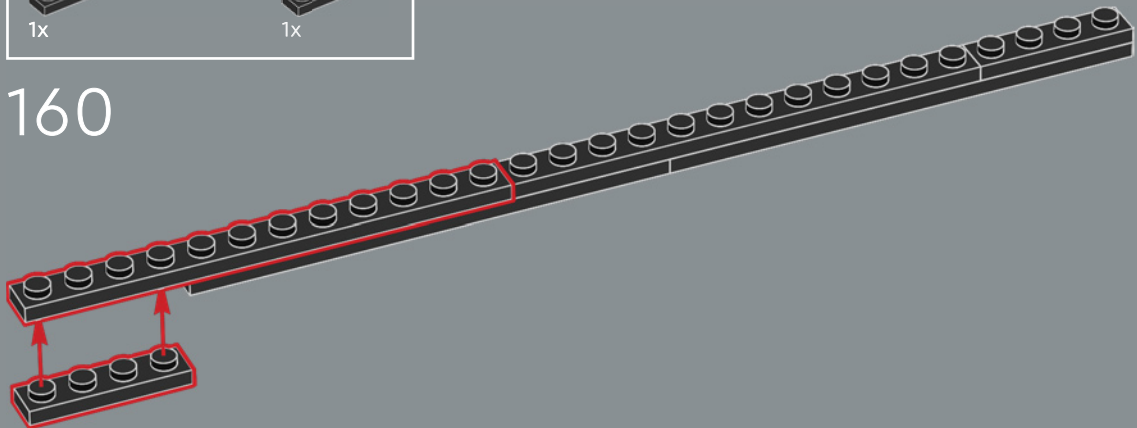

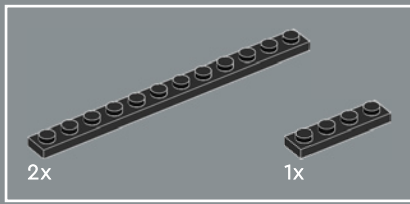

161

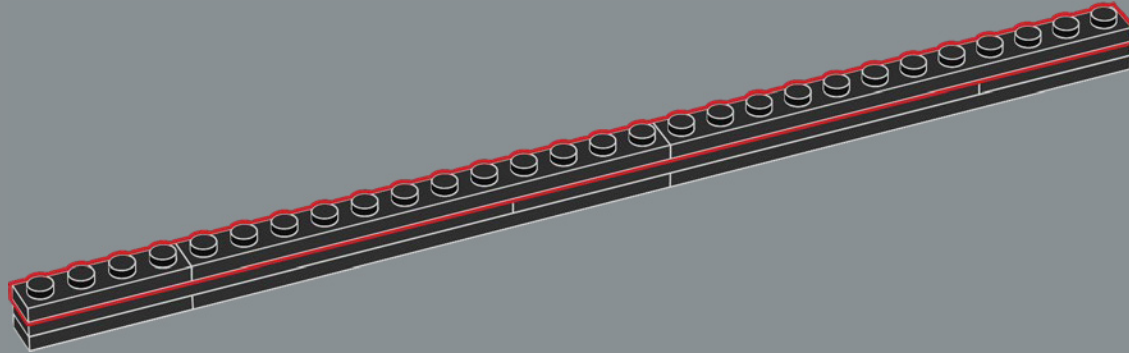

162

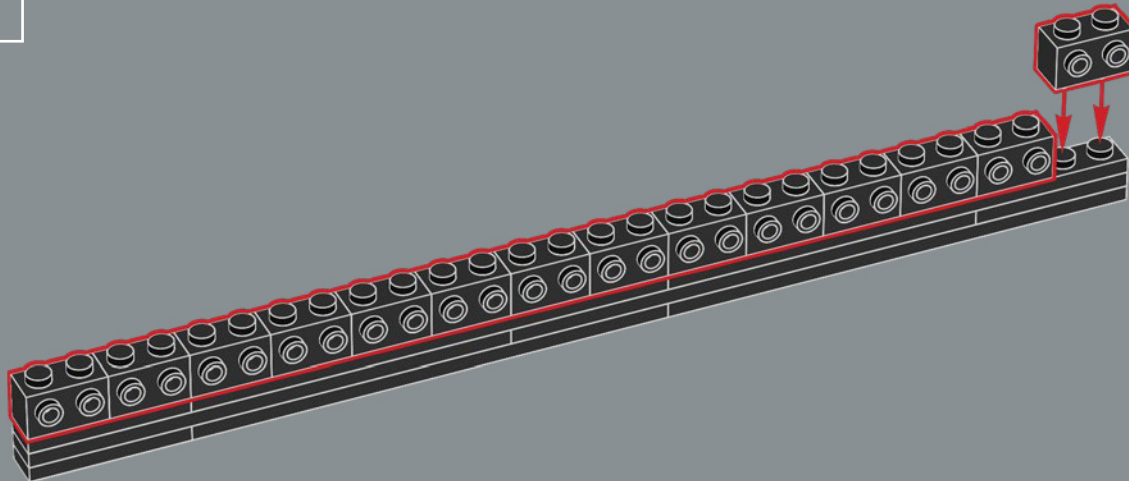

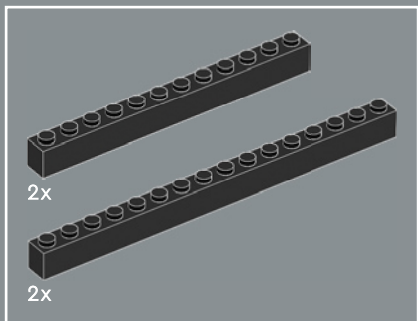

163

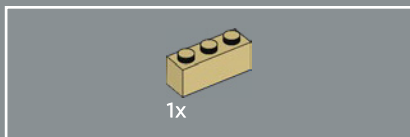
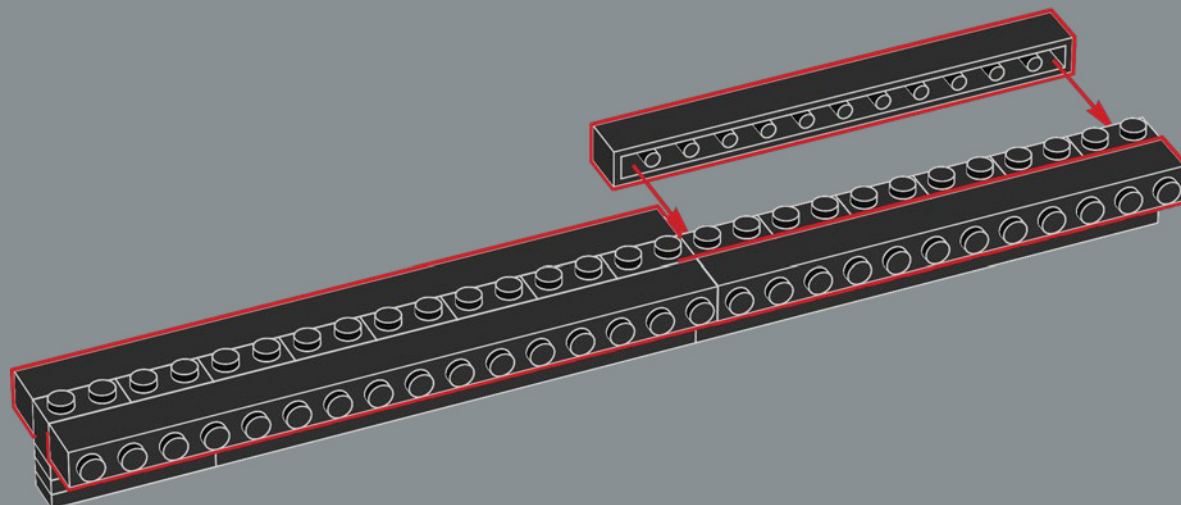

164

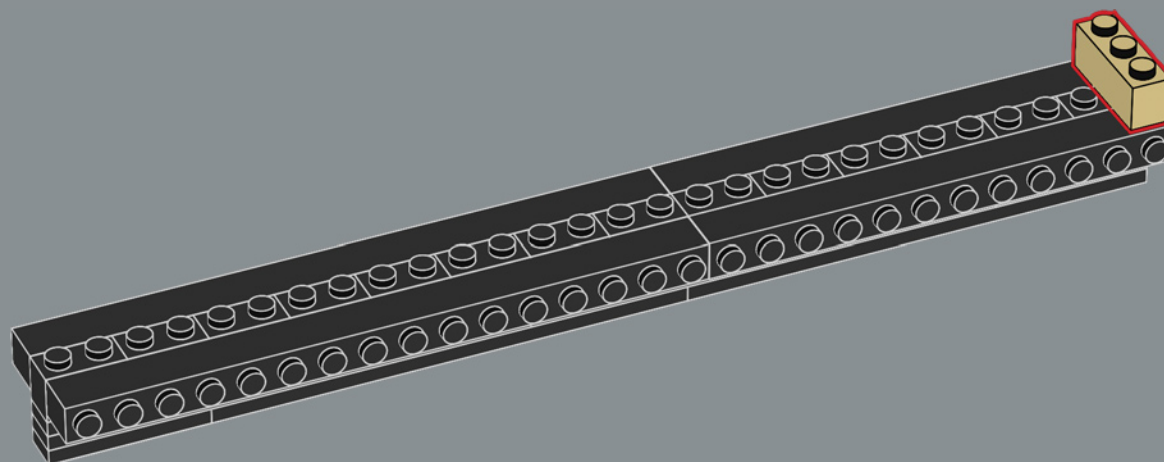

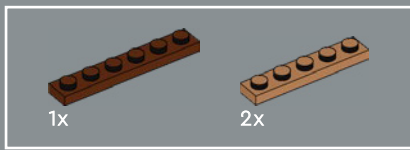

165

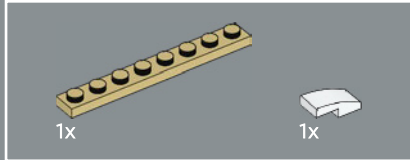
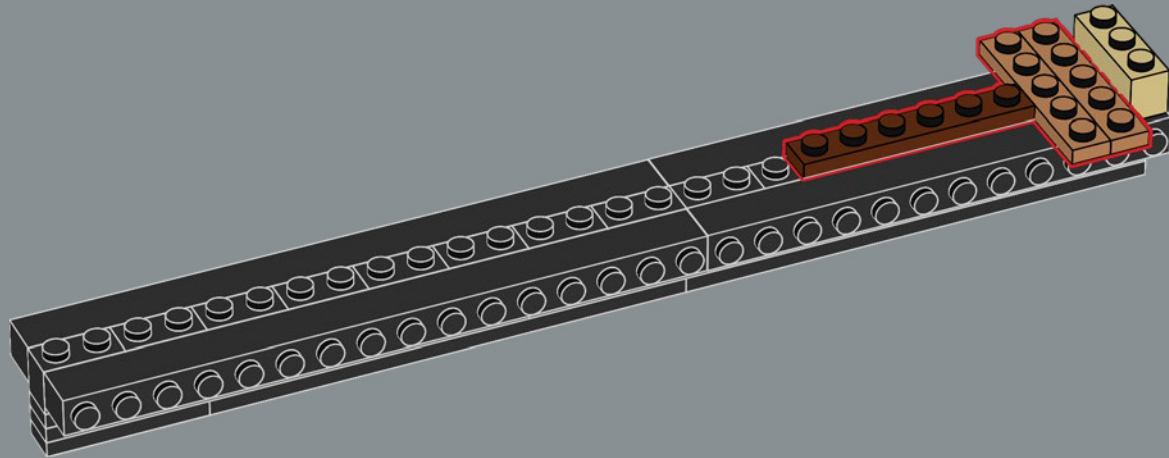

166

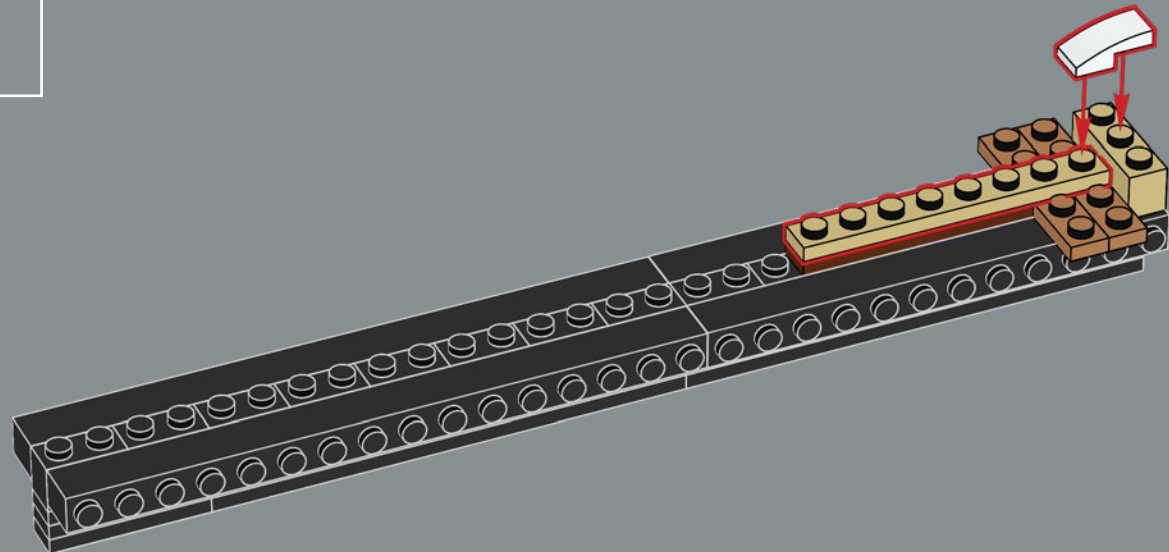

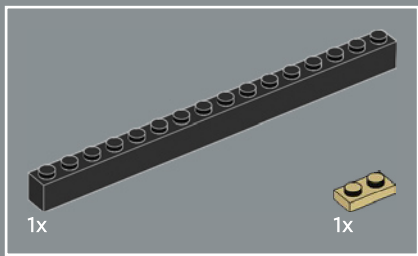

167

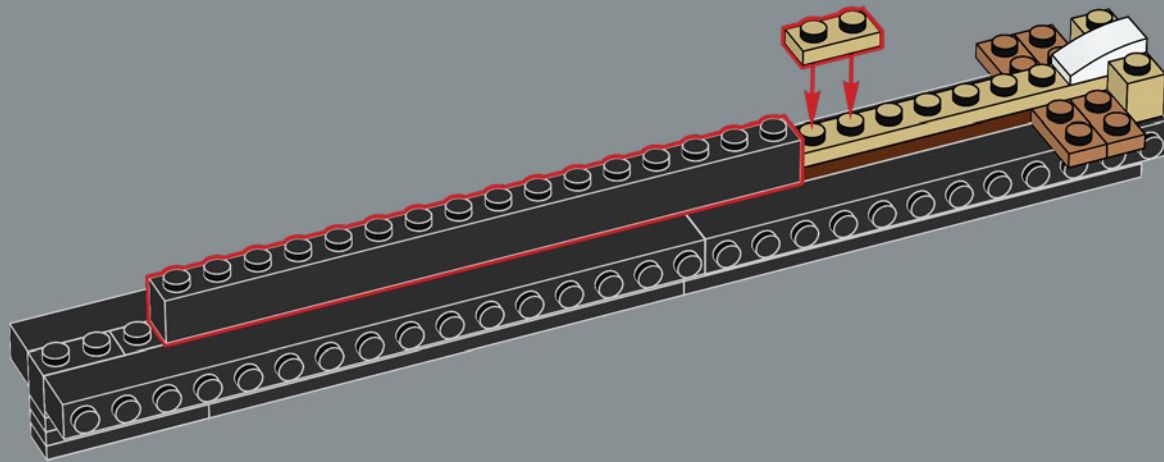

168

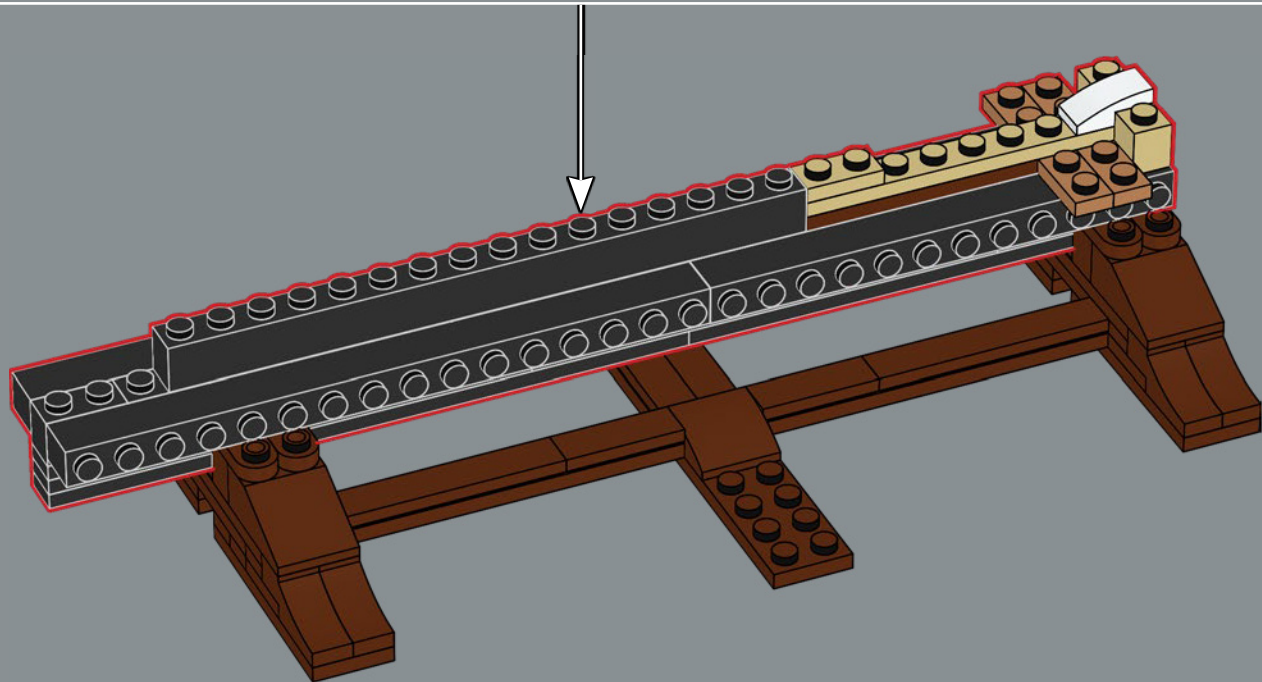



169

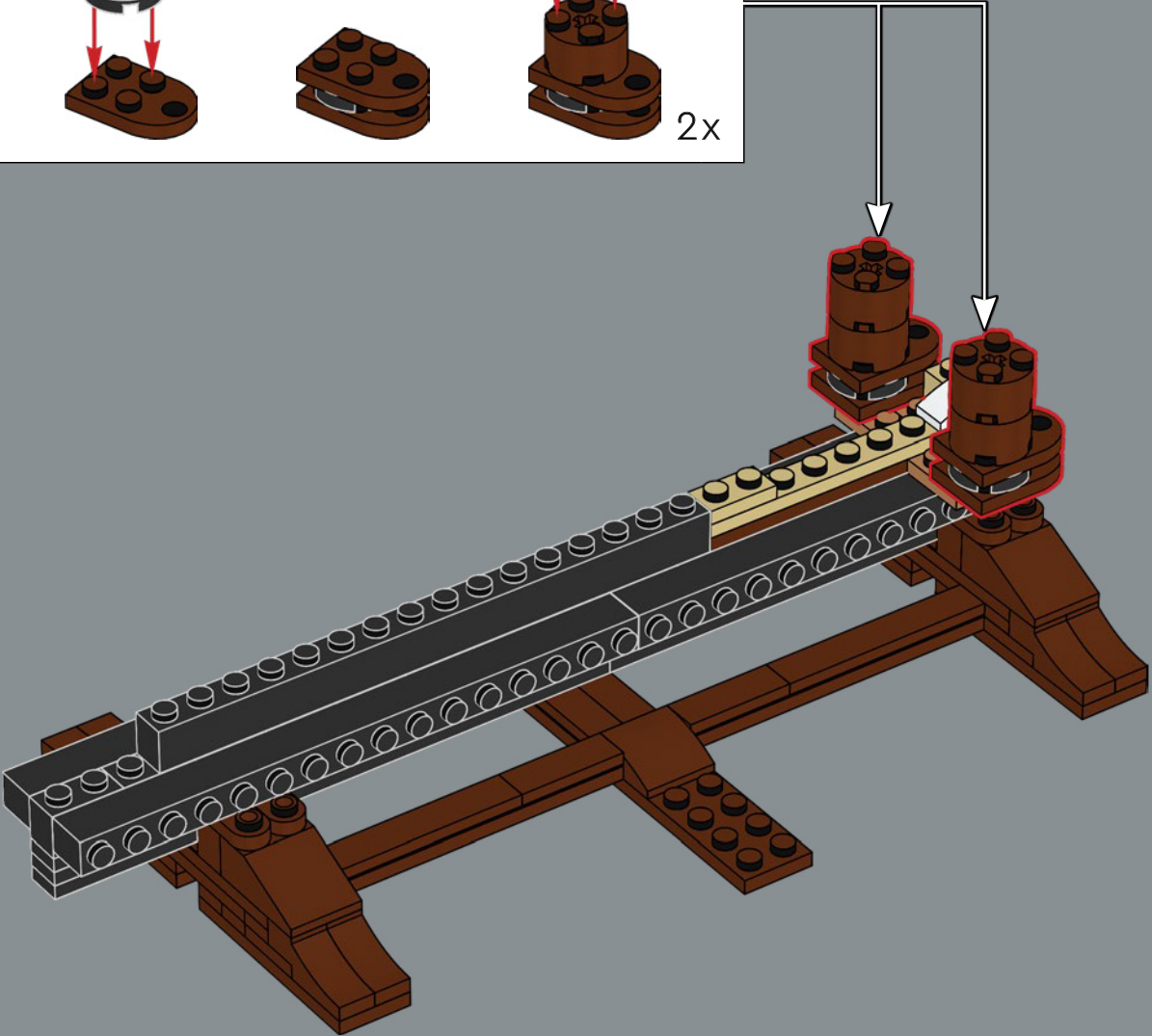
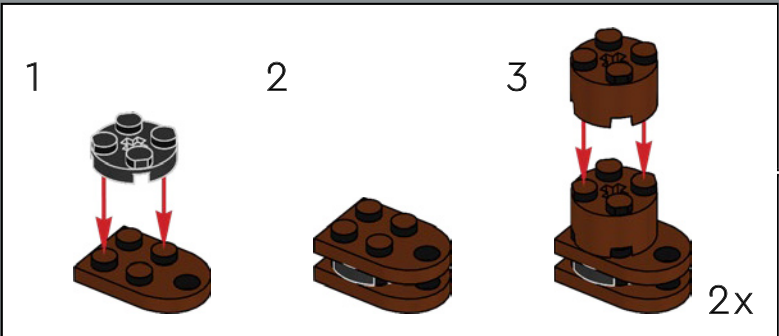

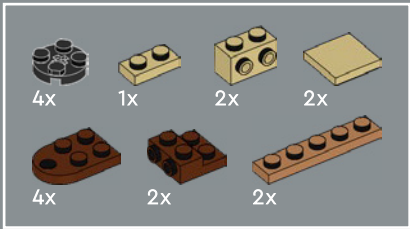

170

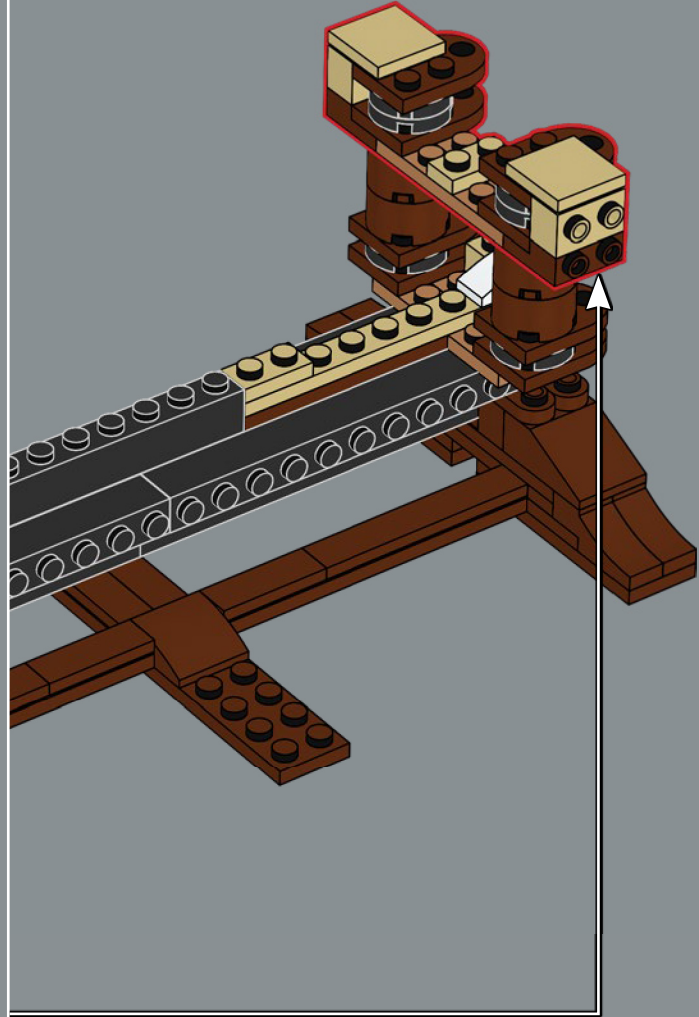
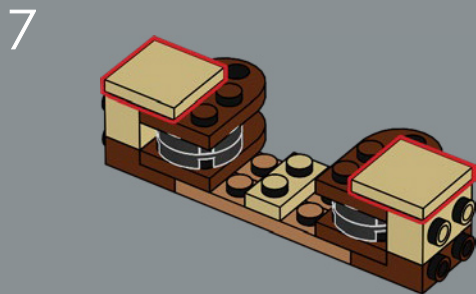
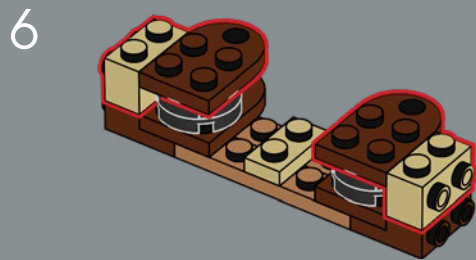
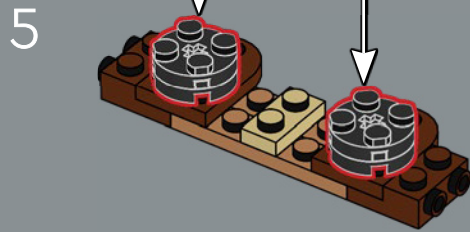
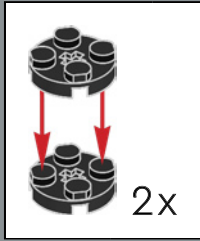
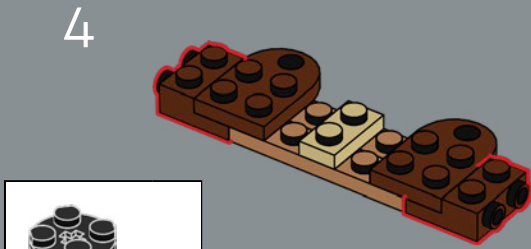
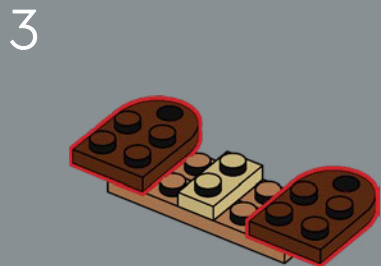
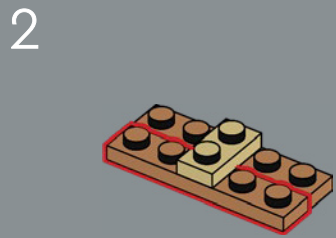
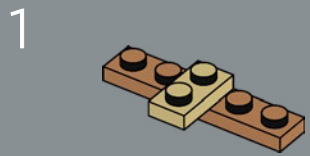

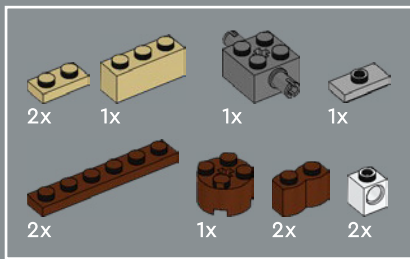

171

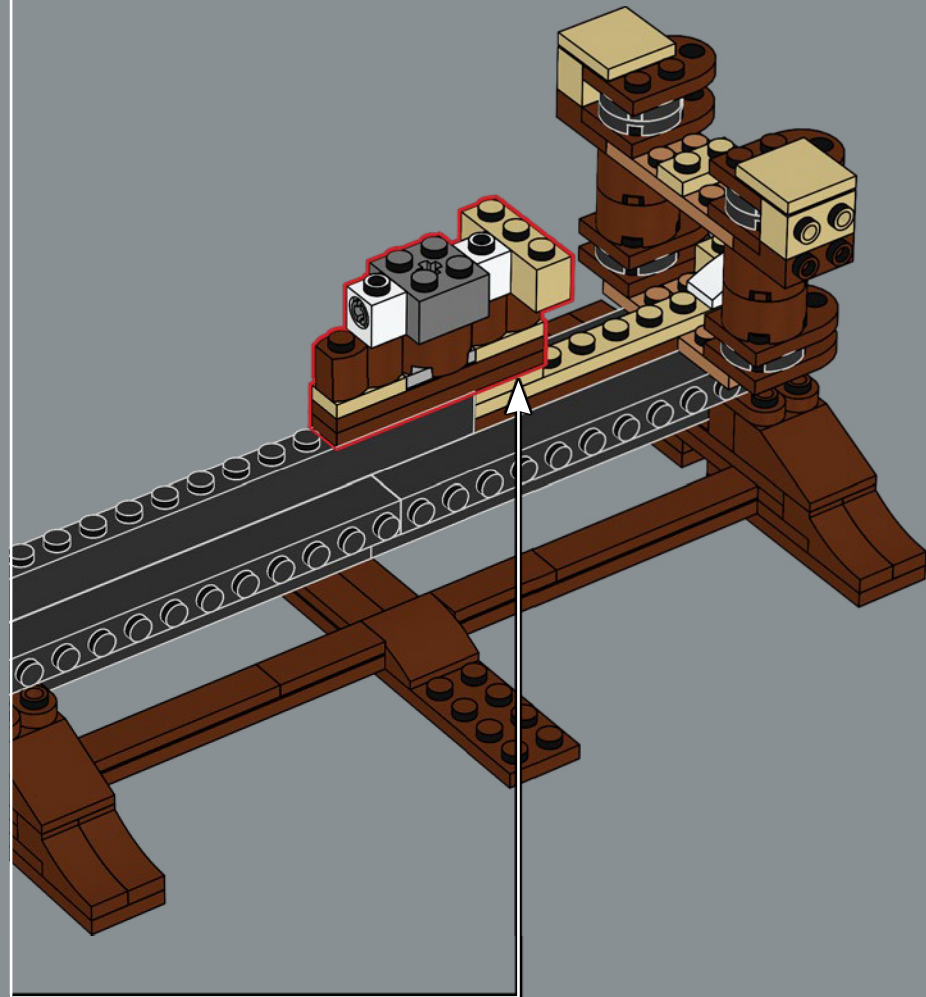
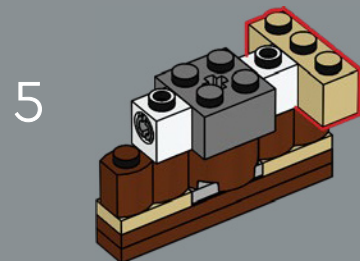
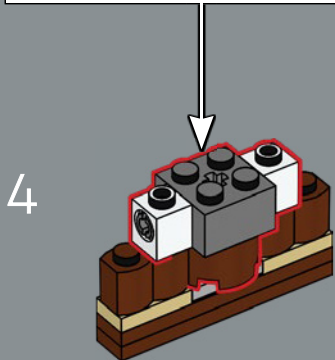
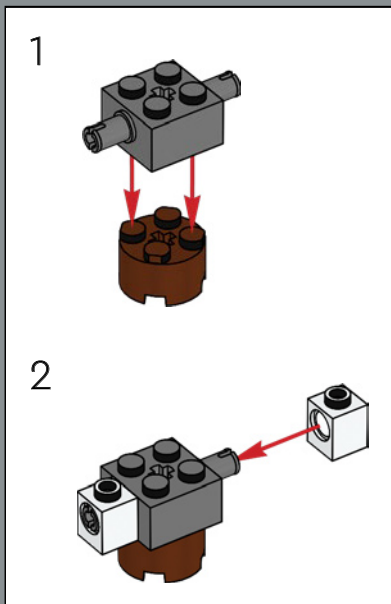
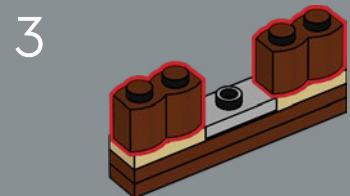
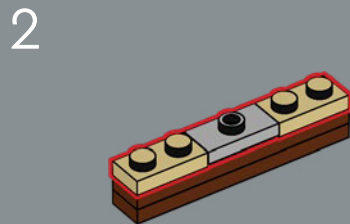
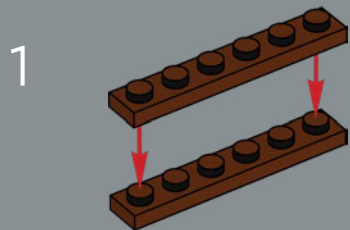

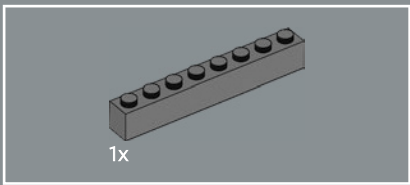

172

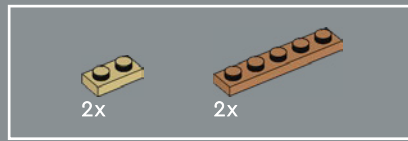
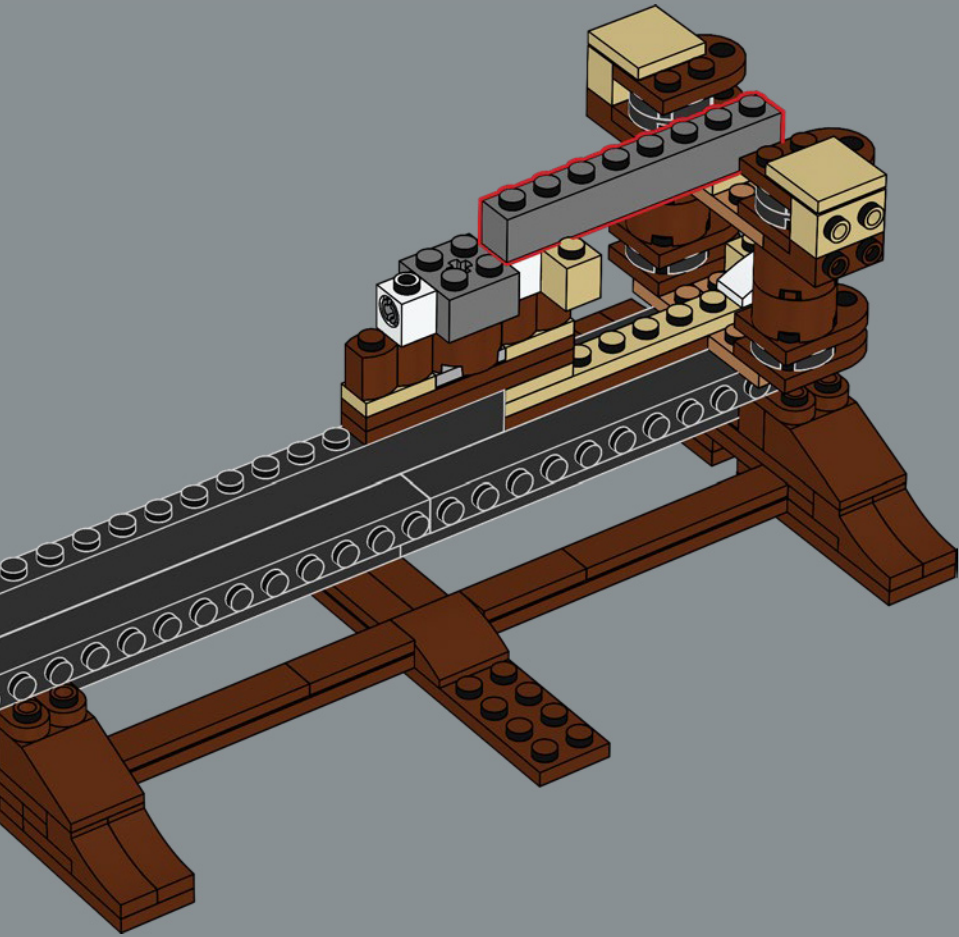

173

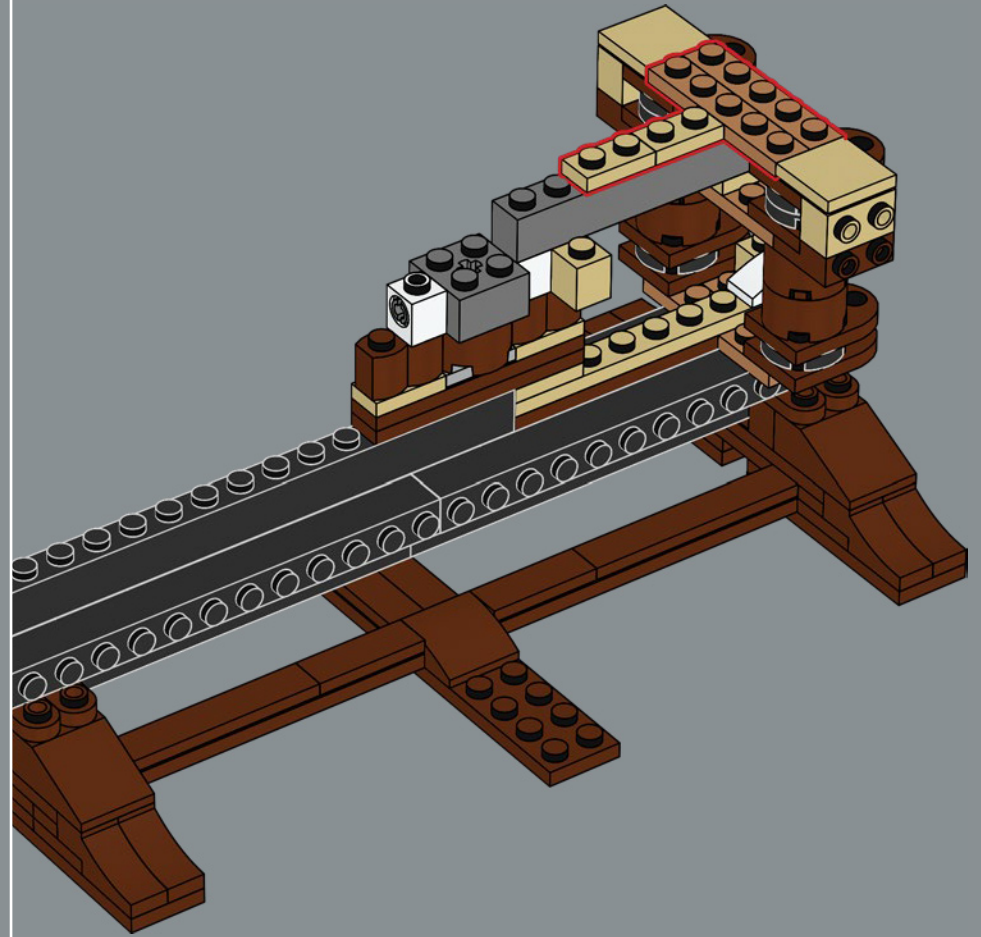

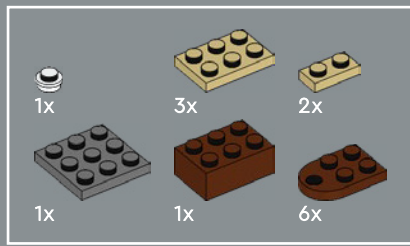

174

1

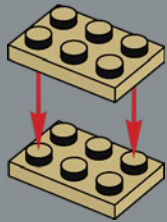

2

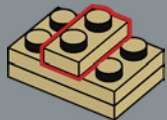

3

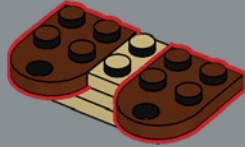

4

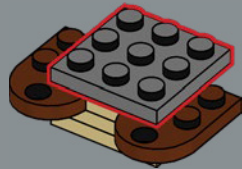

5

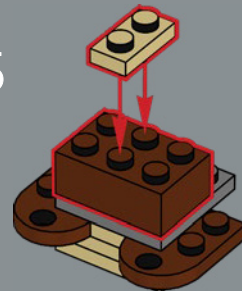

6

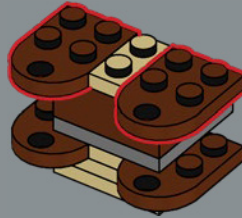

7

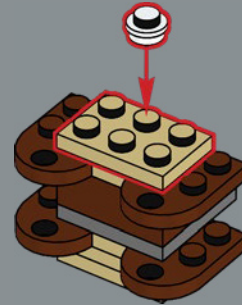

8

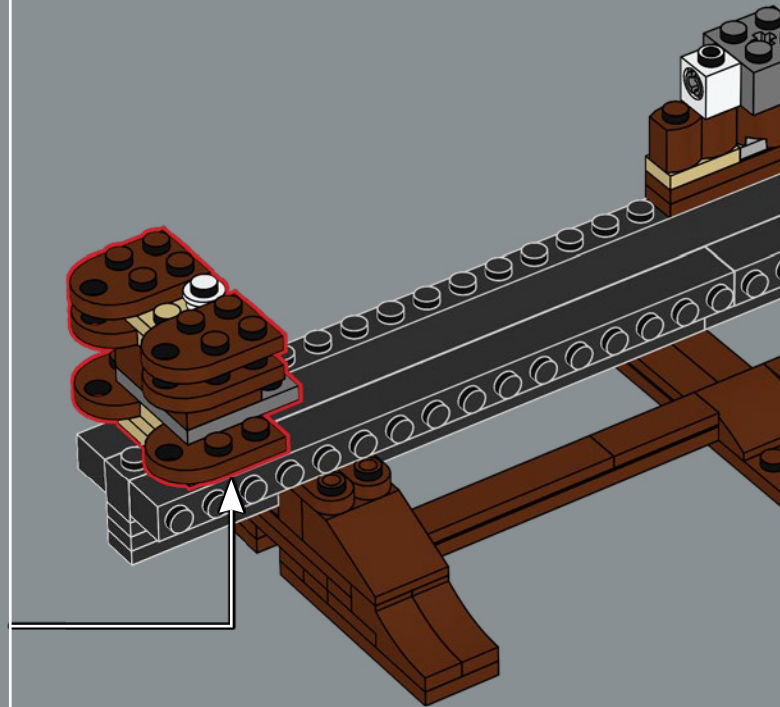
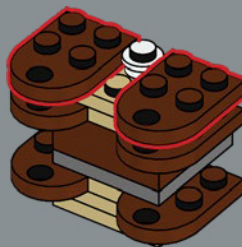

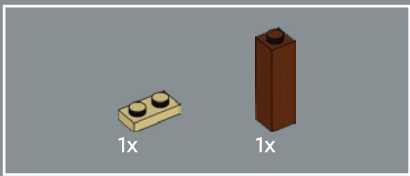

175

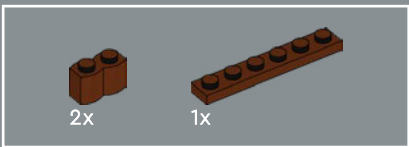
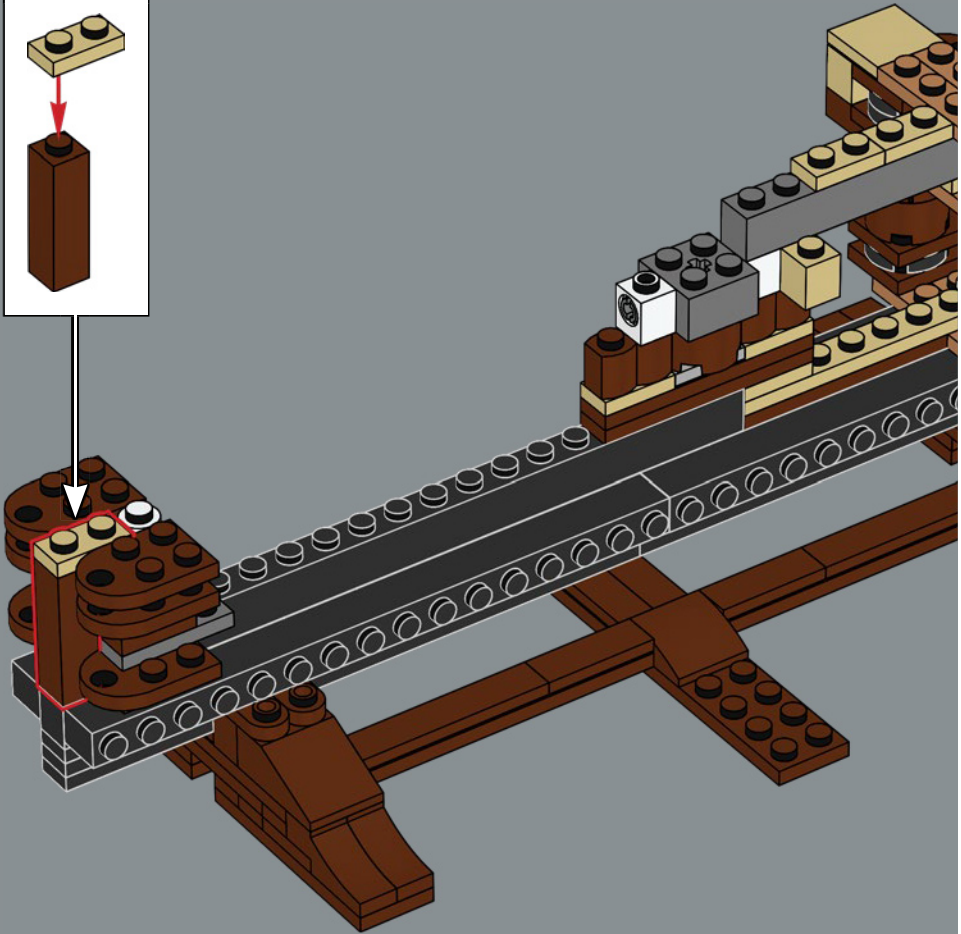
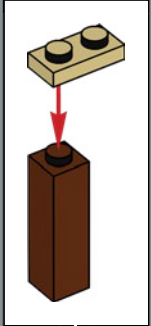

176

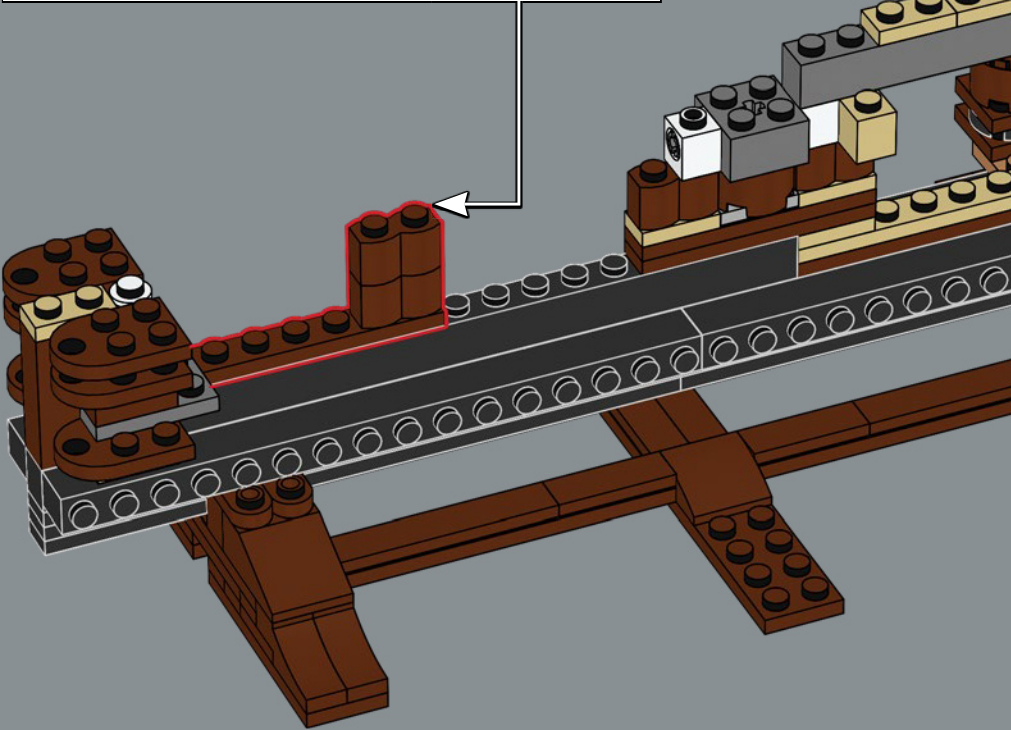
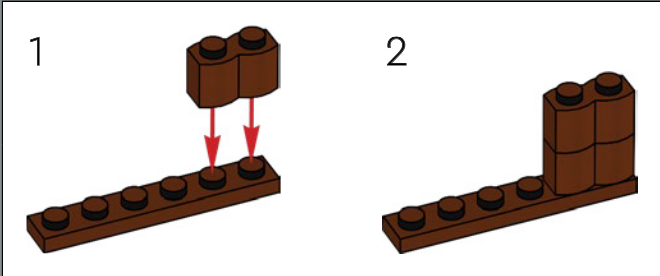

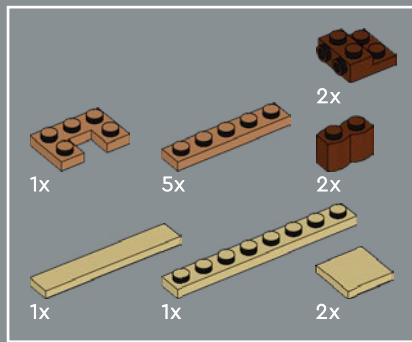

177

1

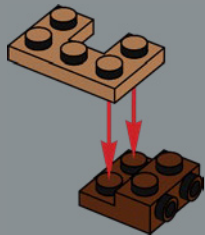

2

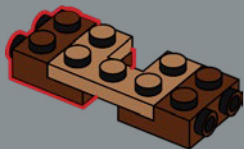

3

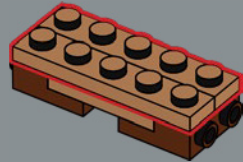

4

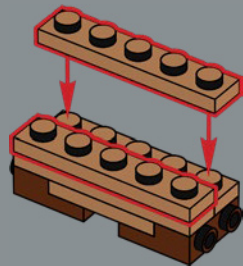

5

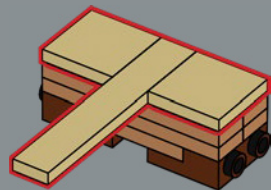

6

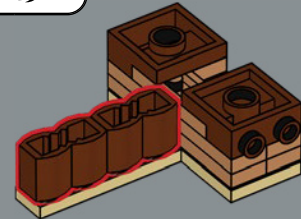

7

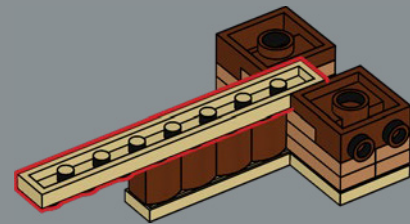

8

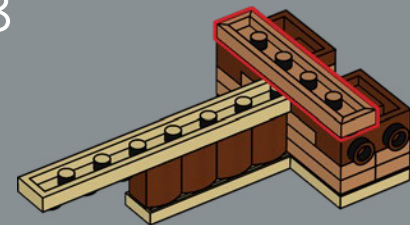

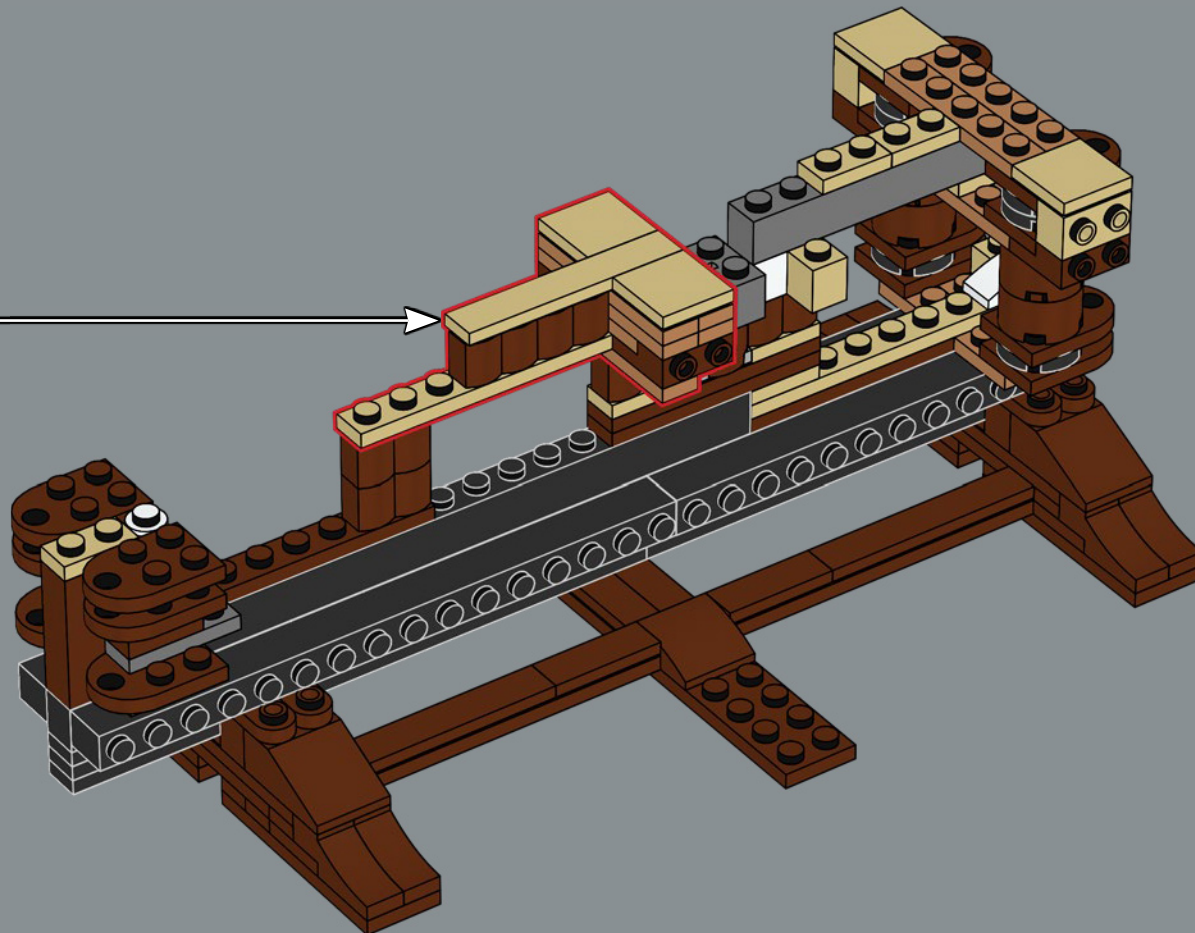

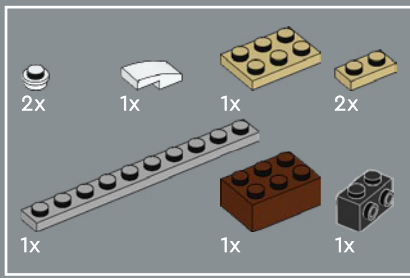

178

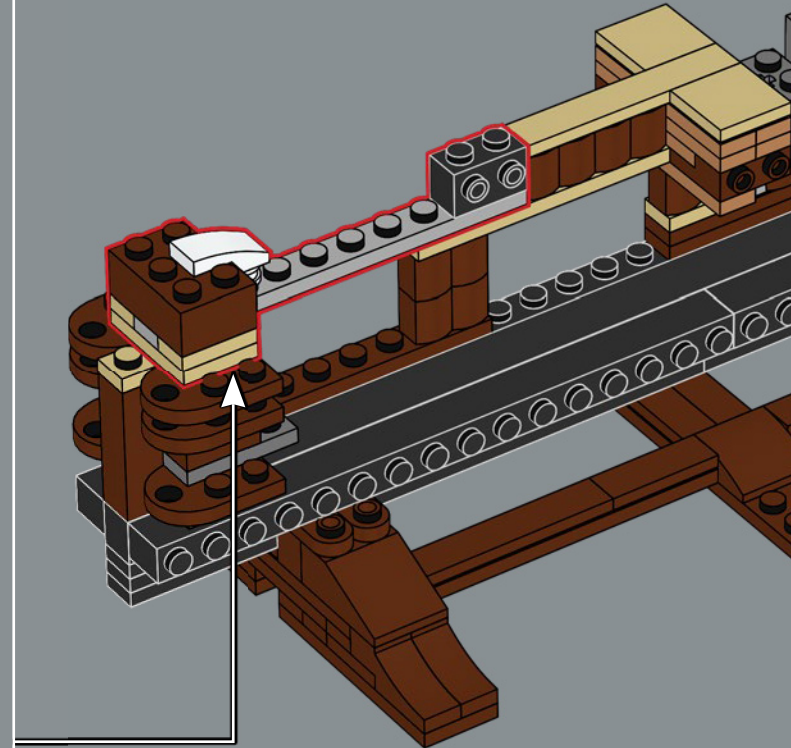
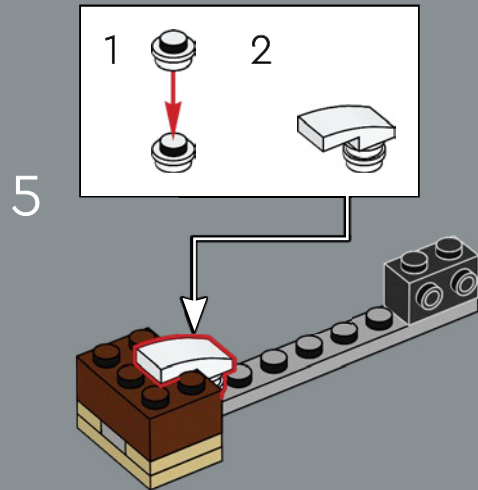
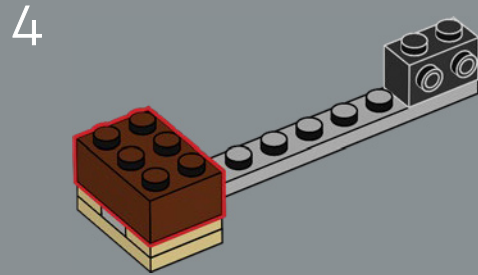
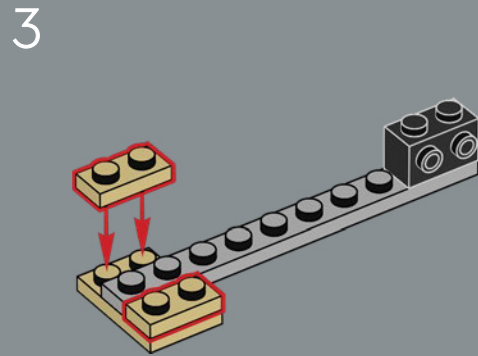
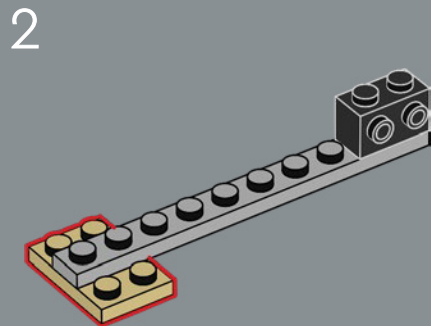
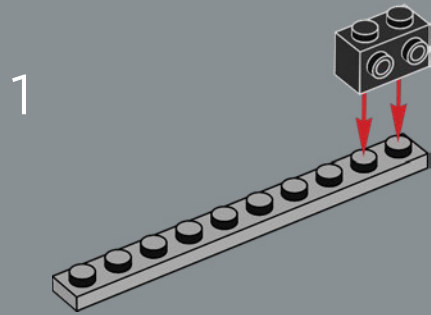

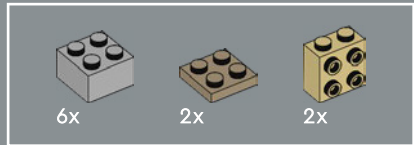

179

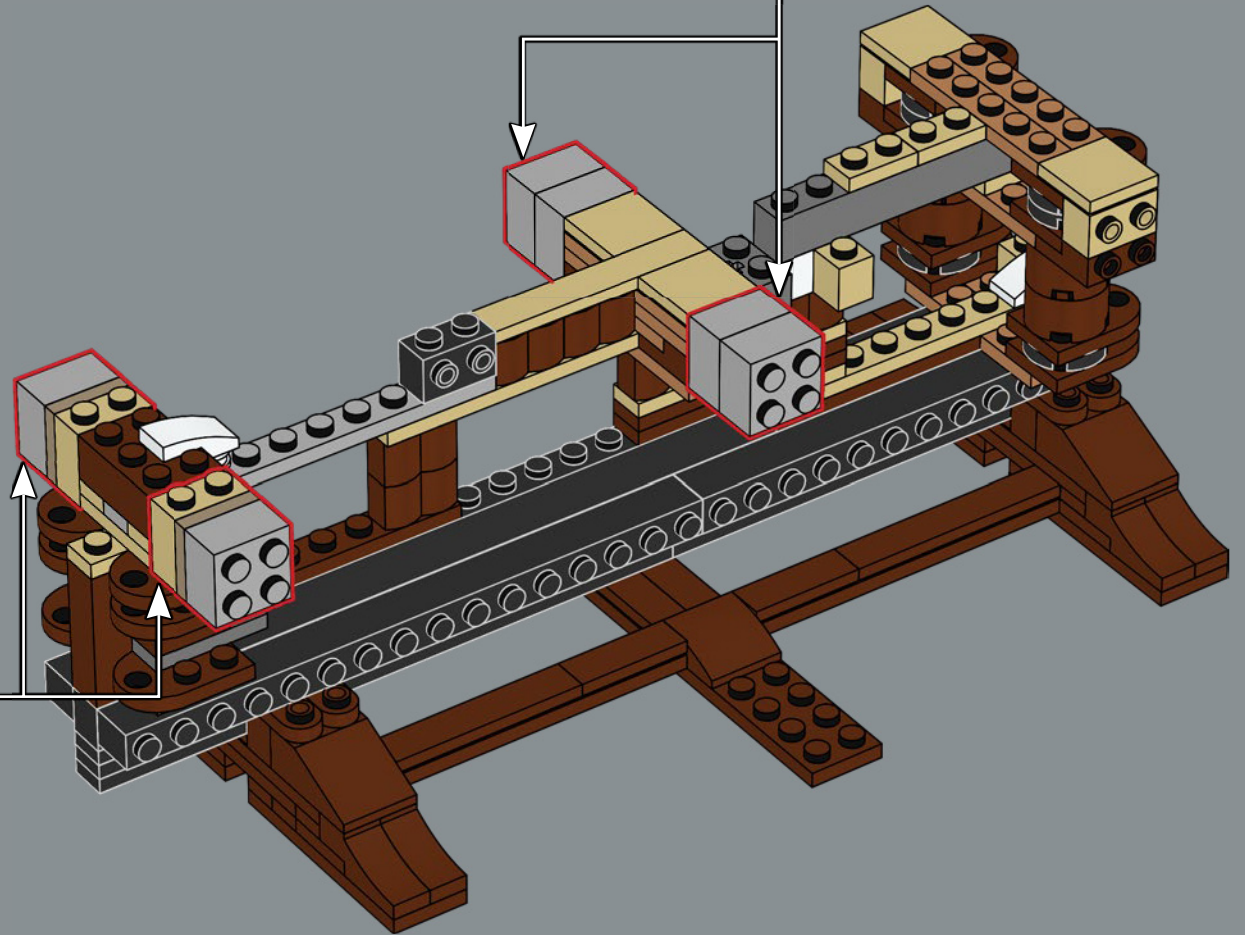
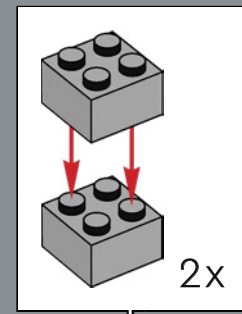
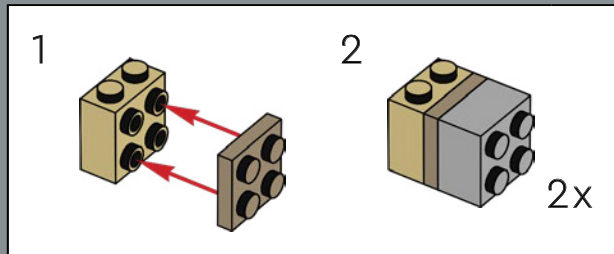

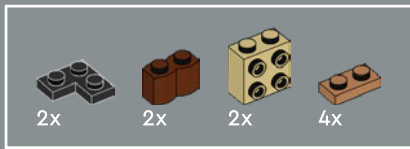

180

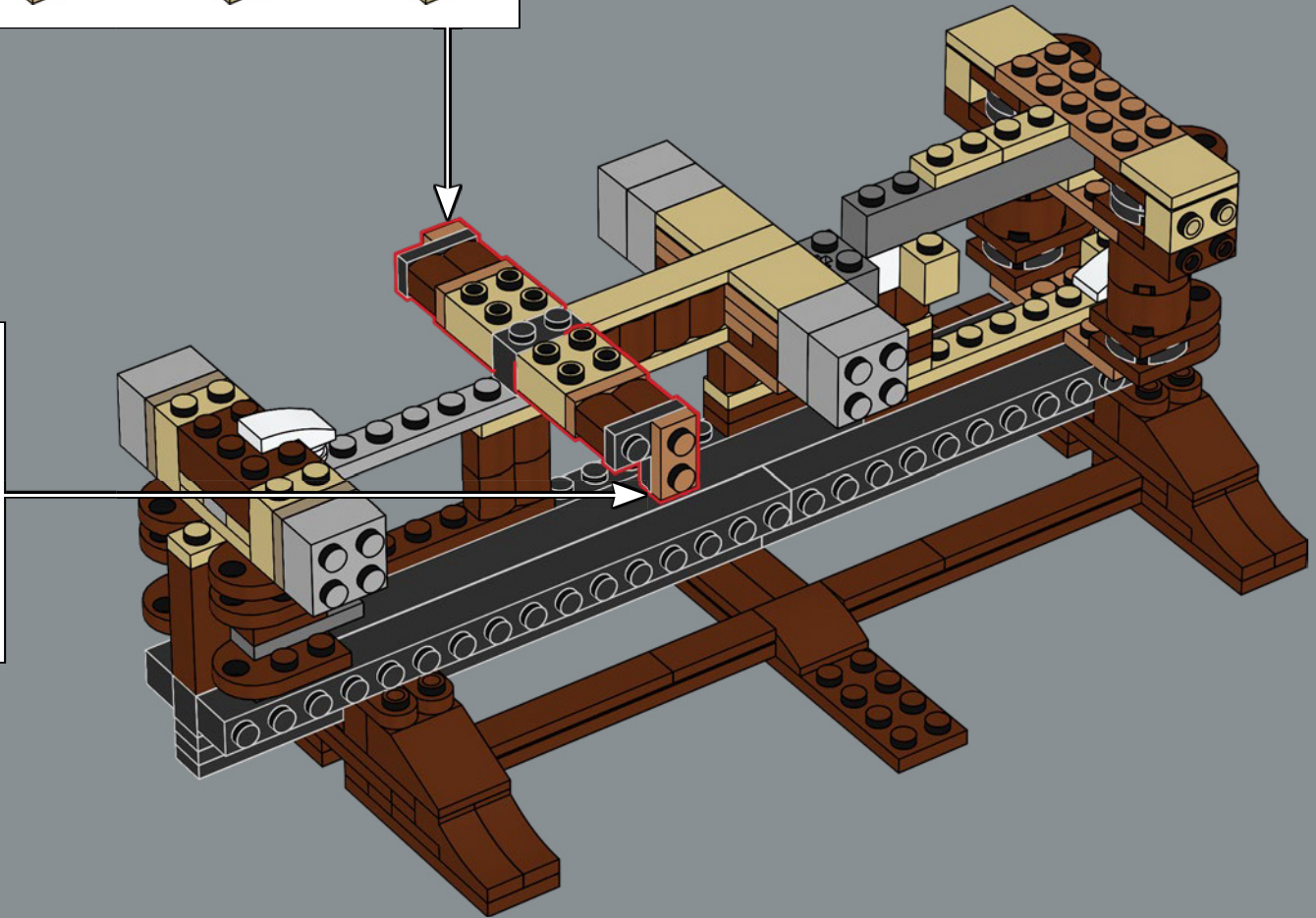
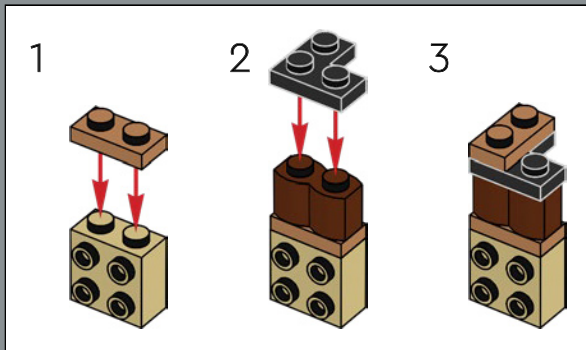
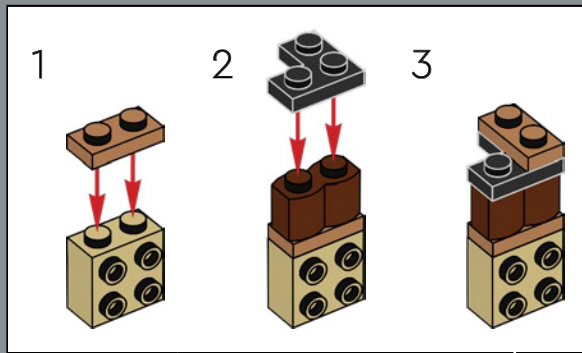

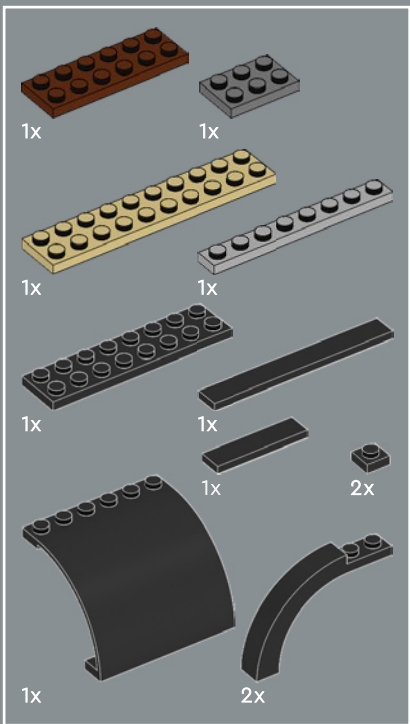

181

1

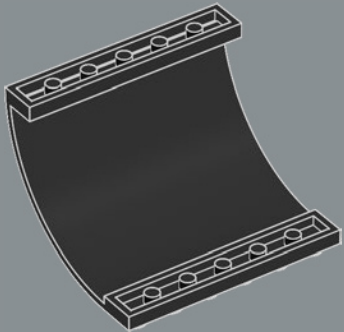

2

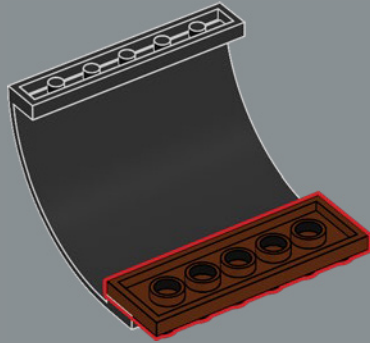

3

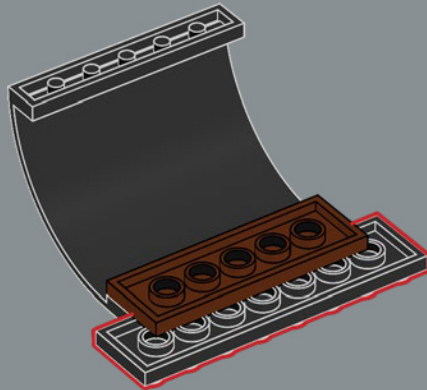

4

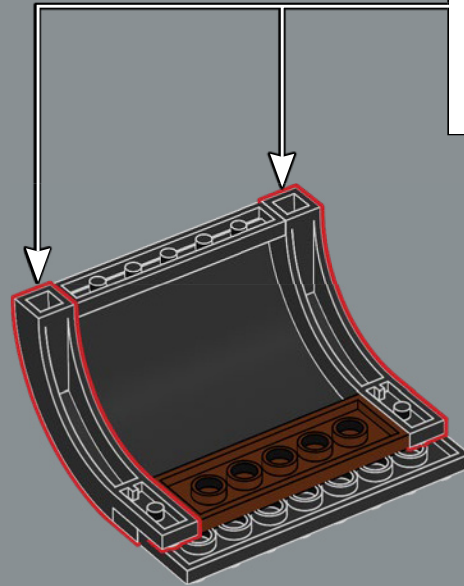

5

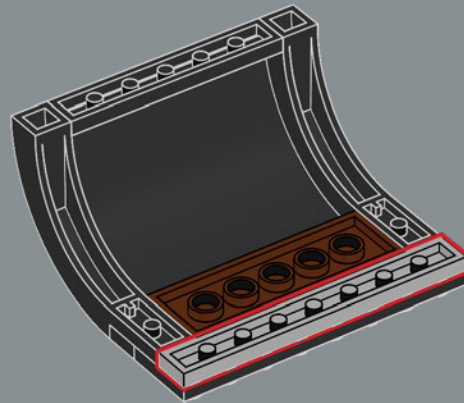

6

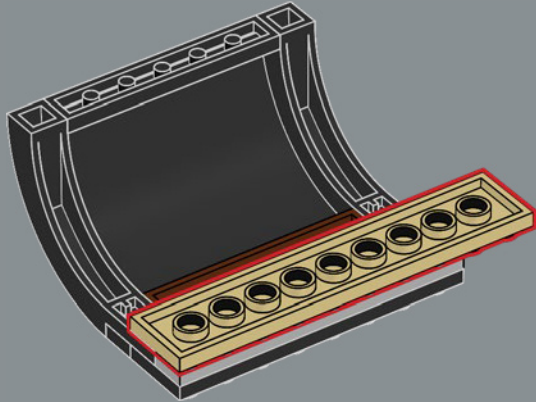

7

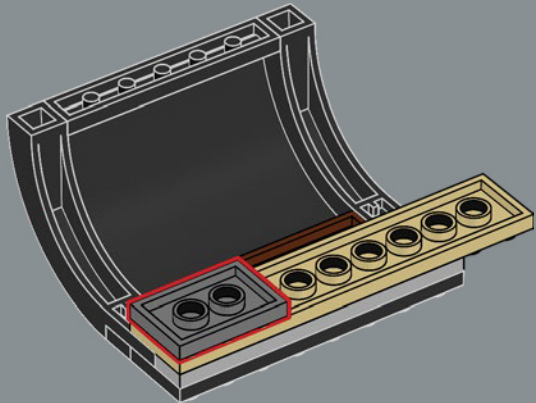

8

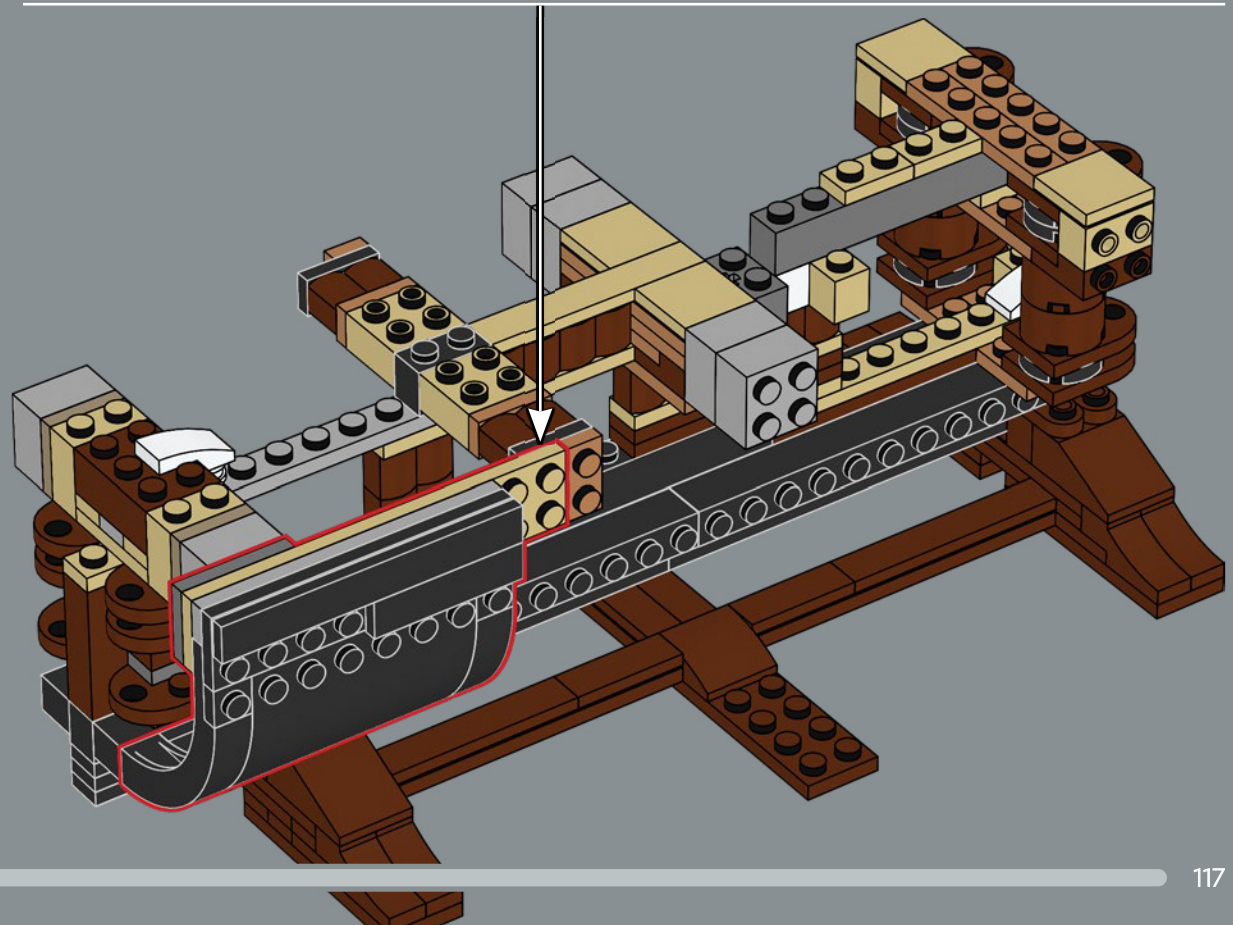
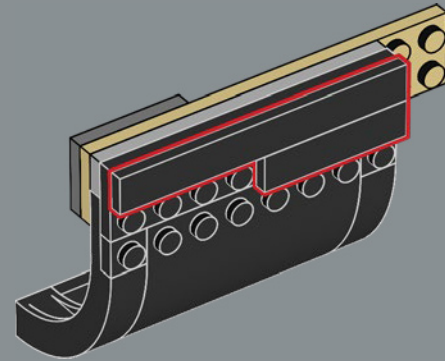

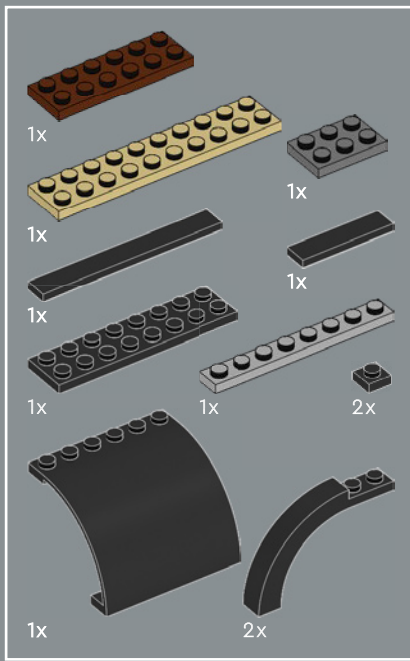

182

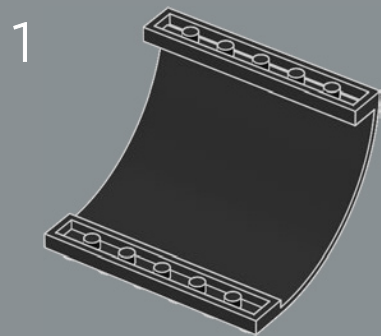

2

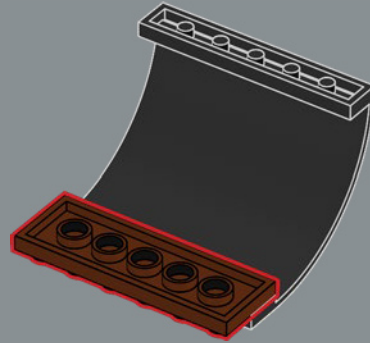

3

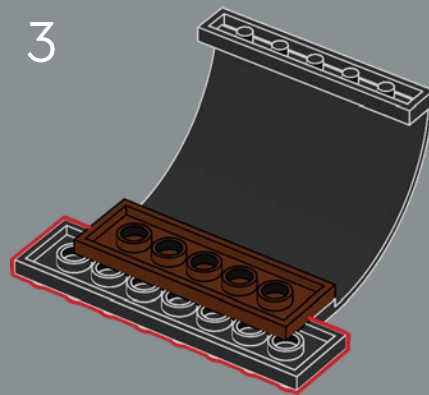

4

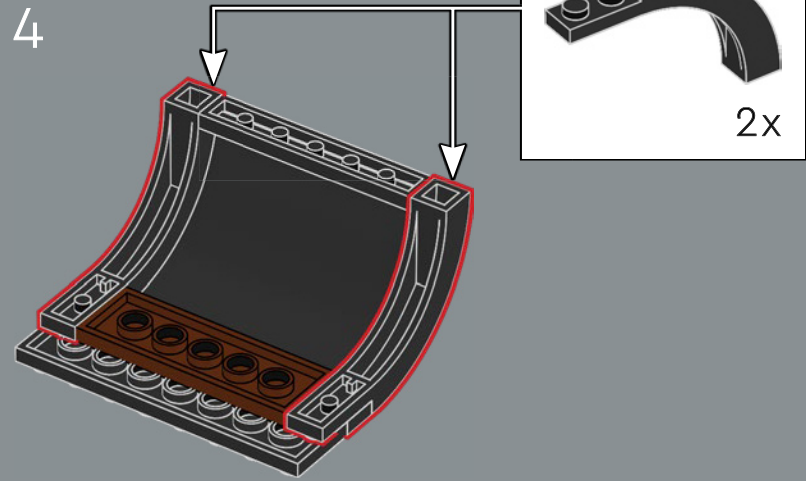

5

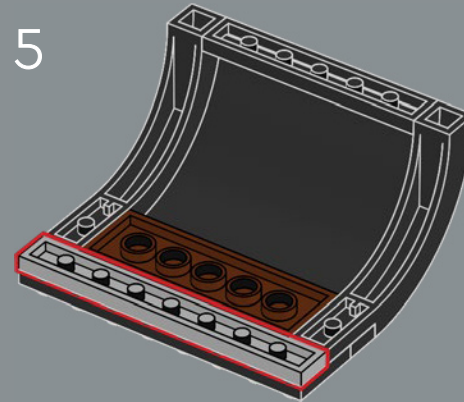

6

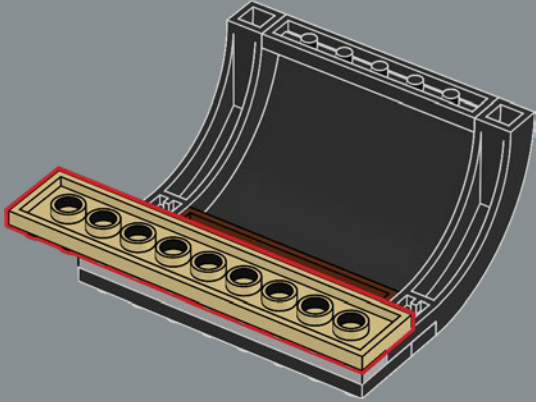

7

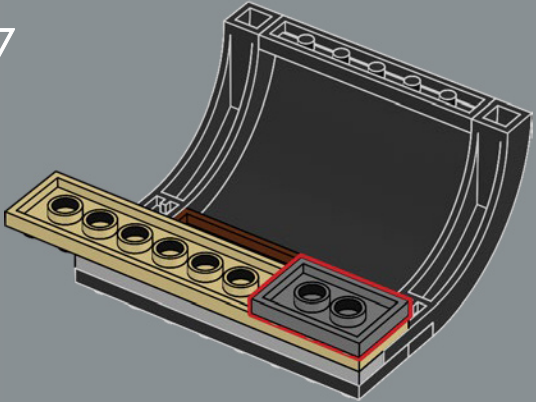

8

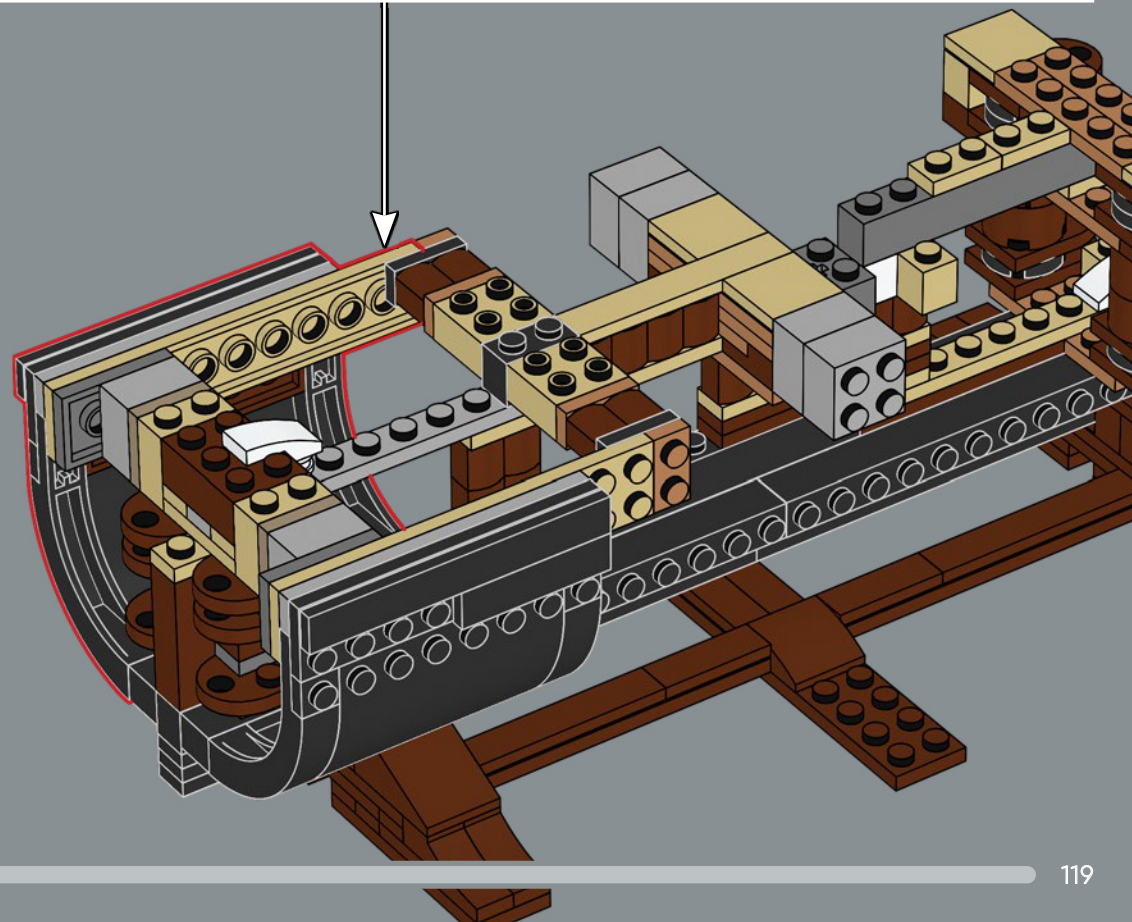
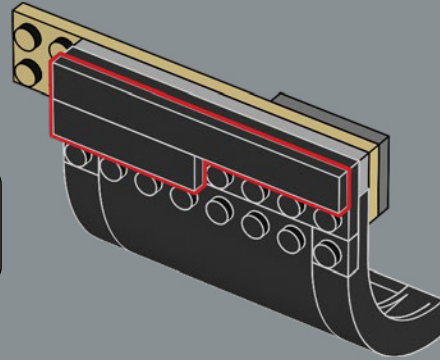

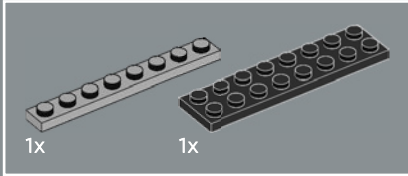
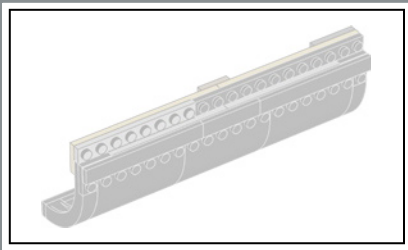

183

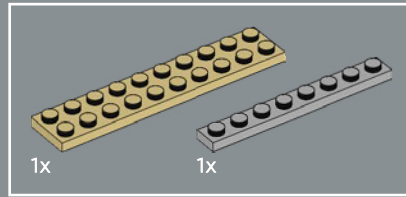
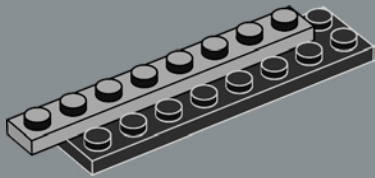

184

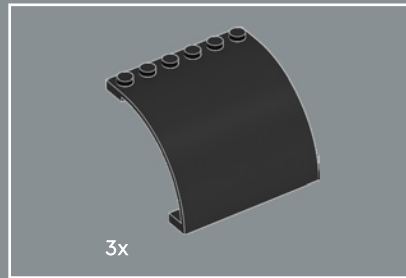
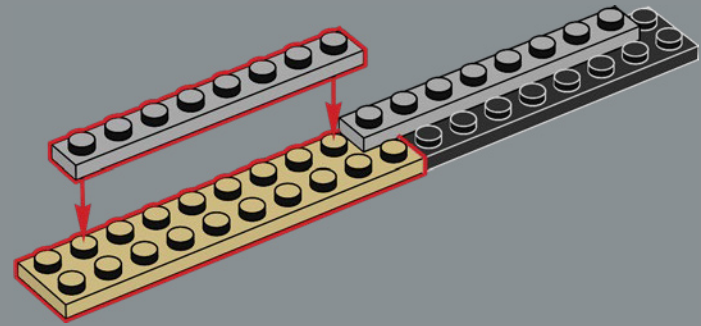

185

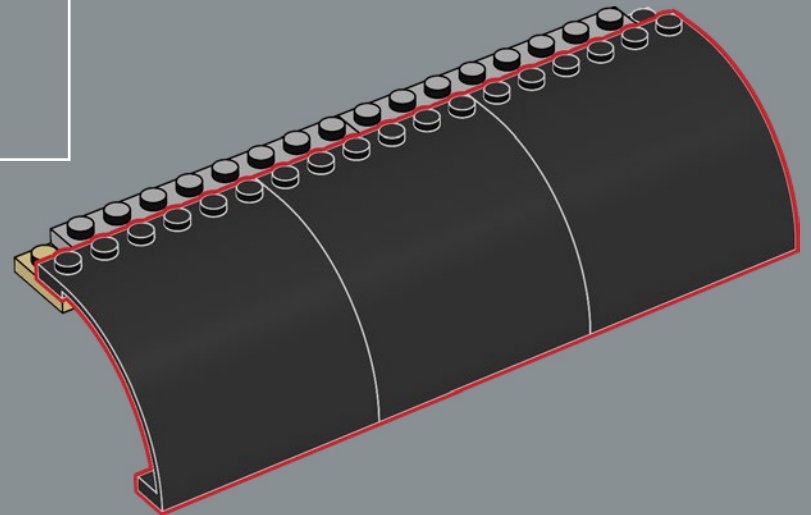



186

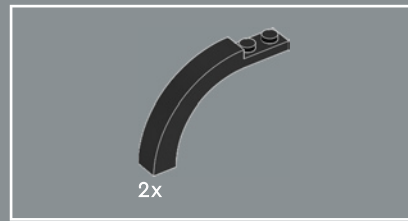
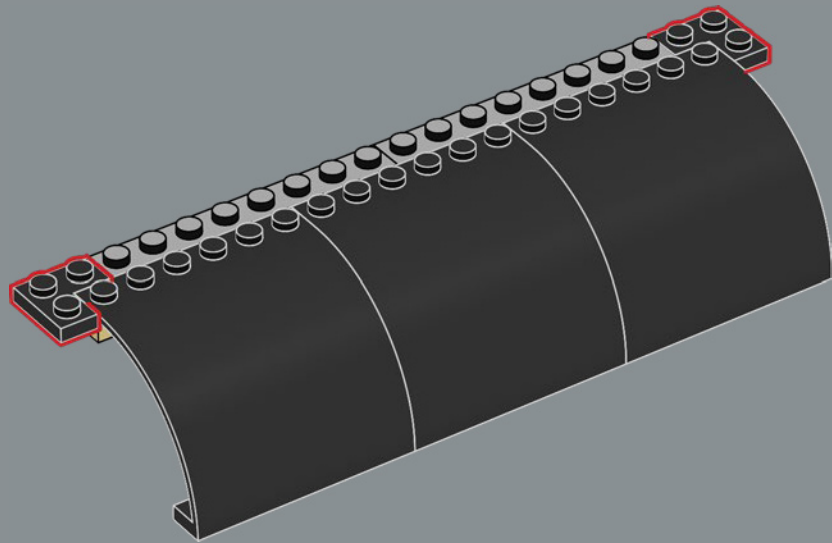

187

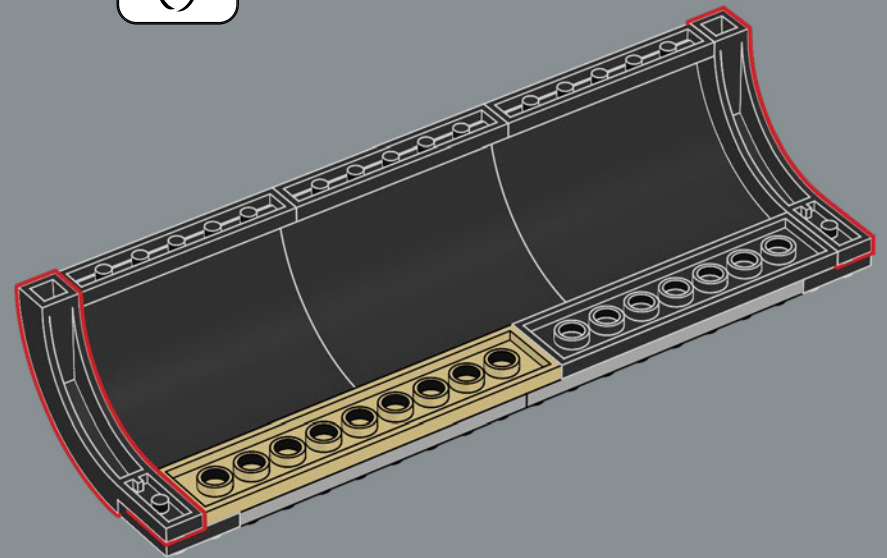

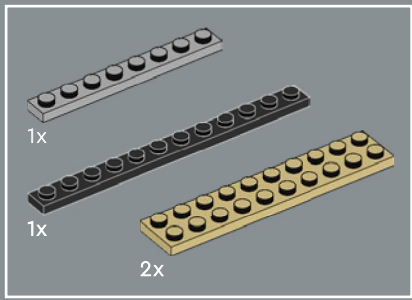

188

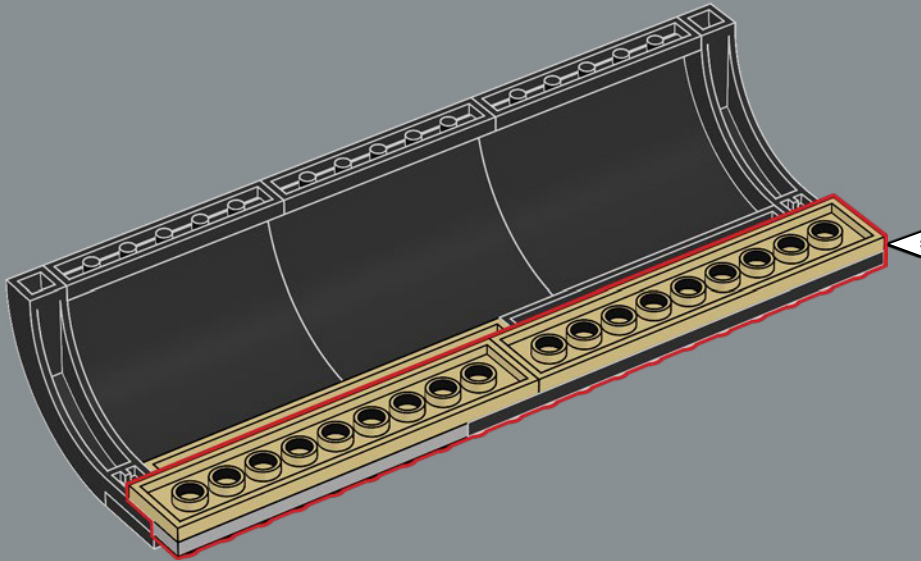
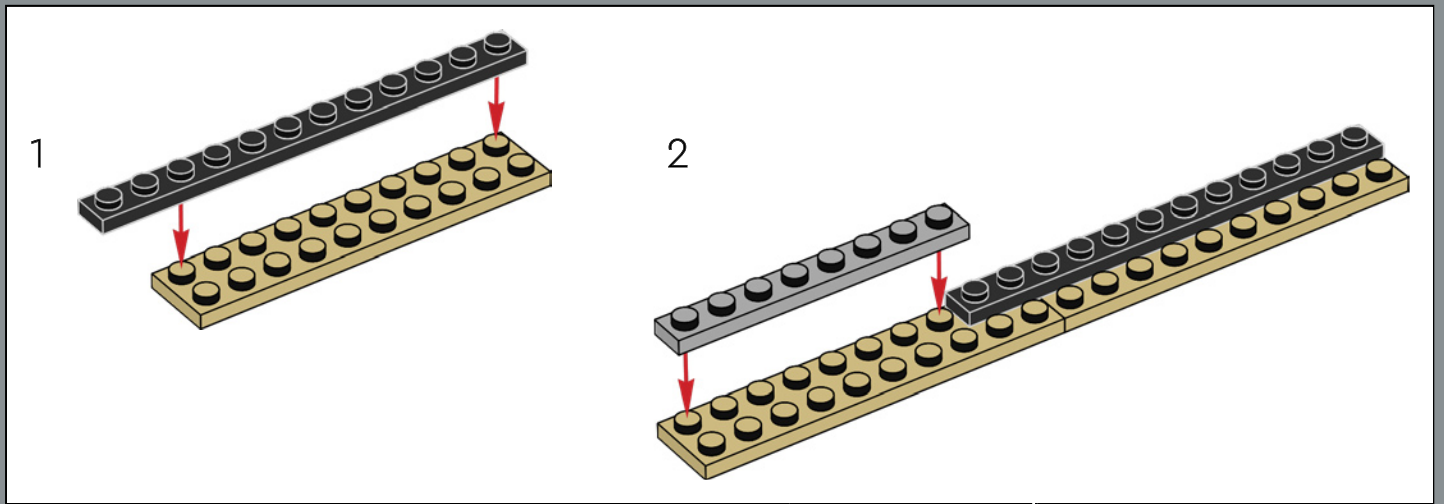



189

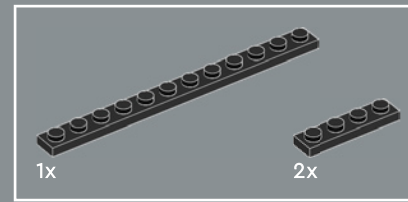
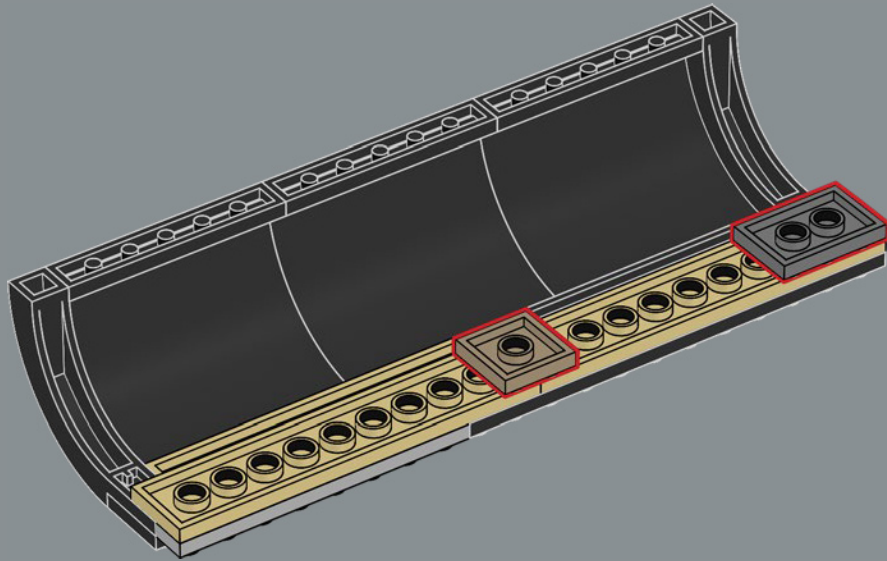

190

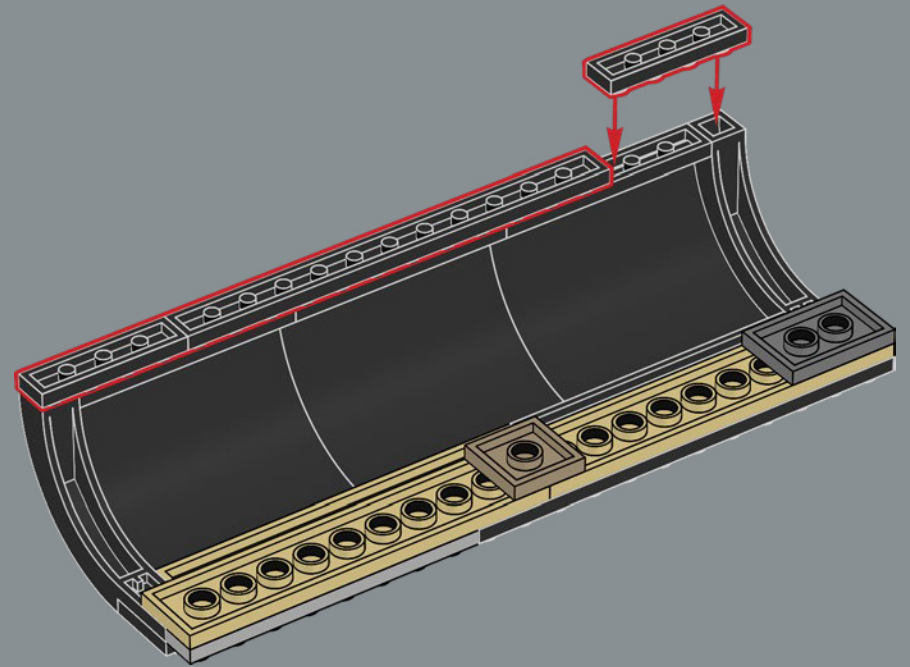

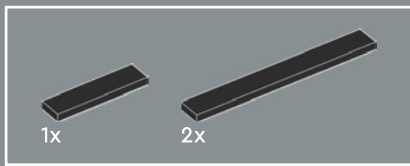

191

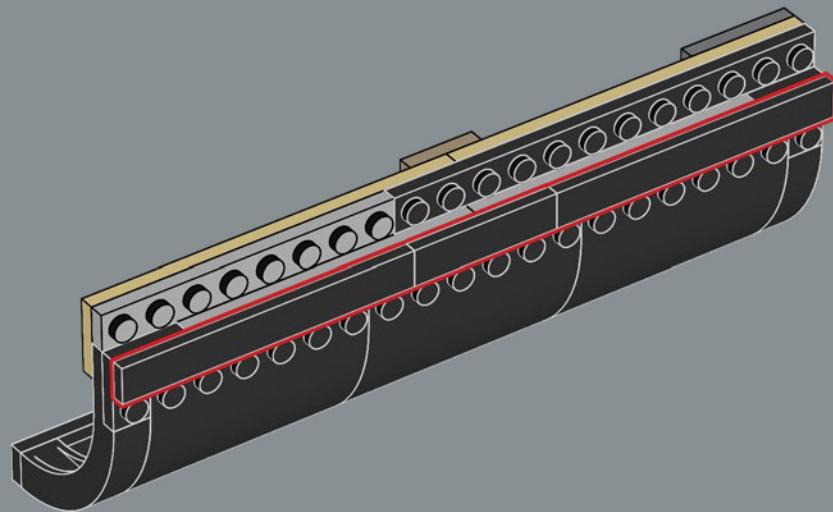

192

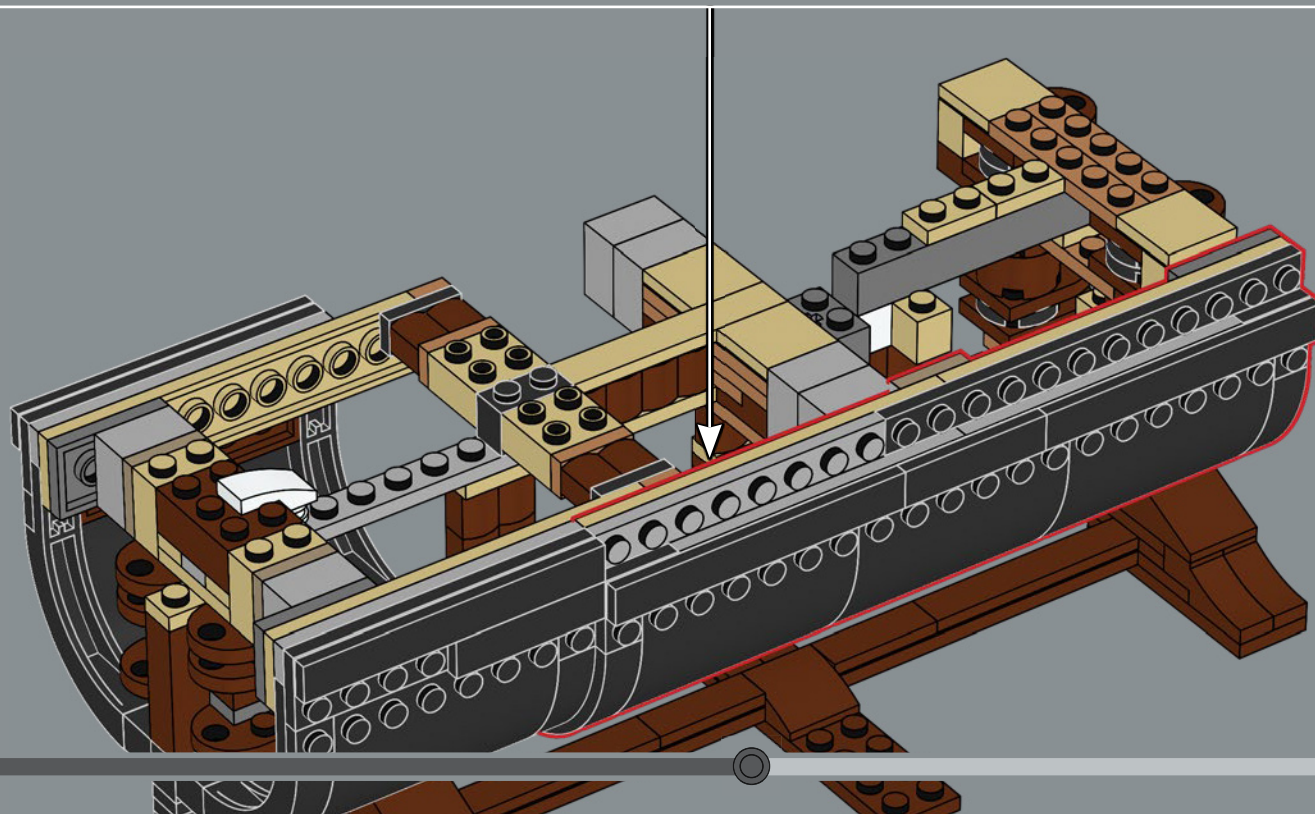

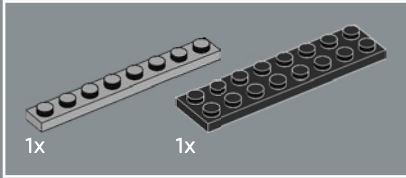
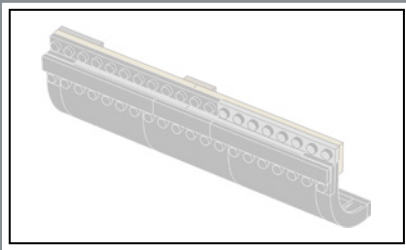

193

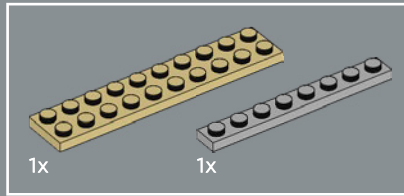
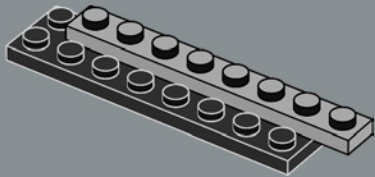

194

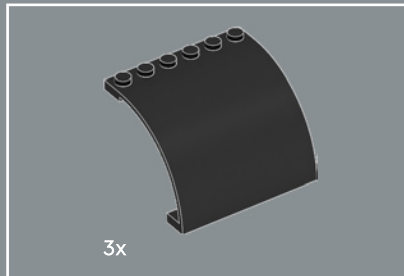

195



I pannelli neri che costituiscono la maggior parte della parte inferiore dello scafo della nave sono elementi "muro" in termini di design LEGO®. Realizzati in nero, le loro dimensioni e forma erano perfette per lo scafo della nave.

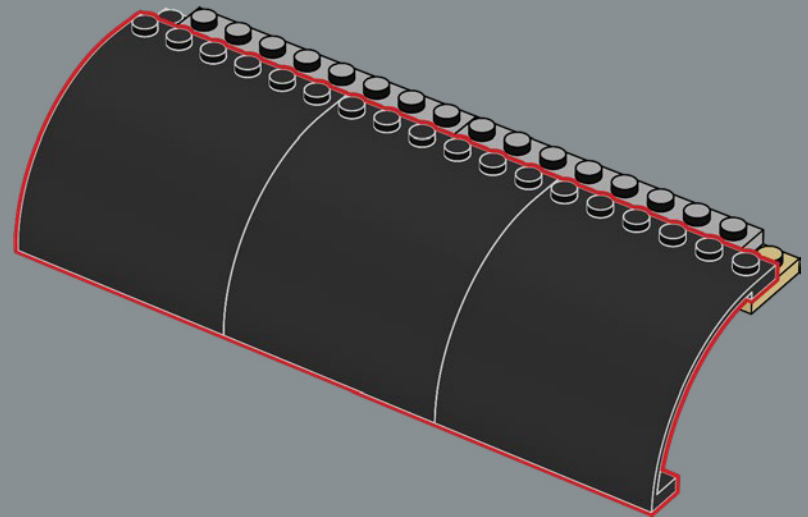
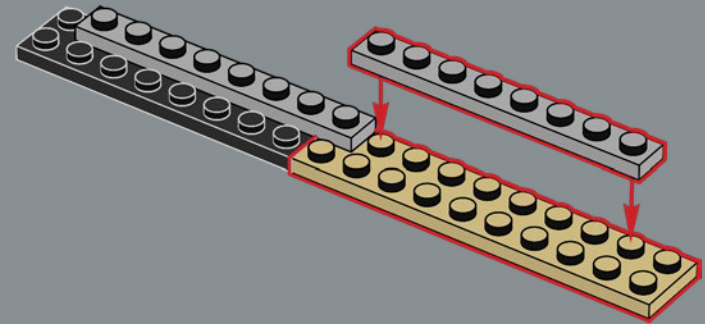

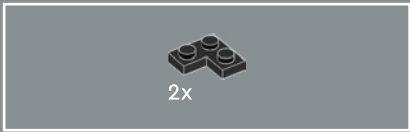

196

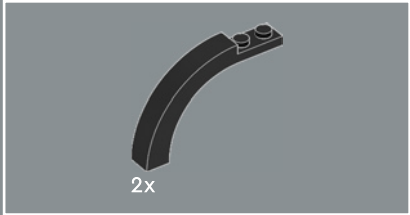
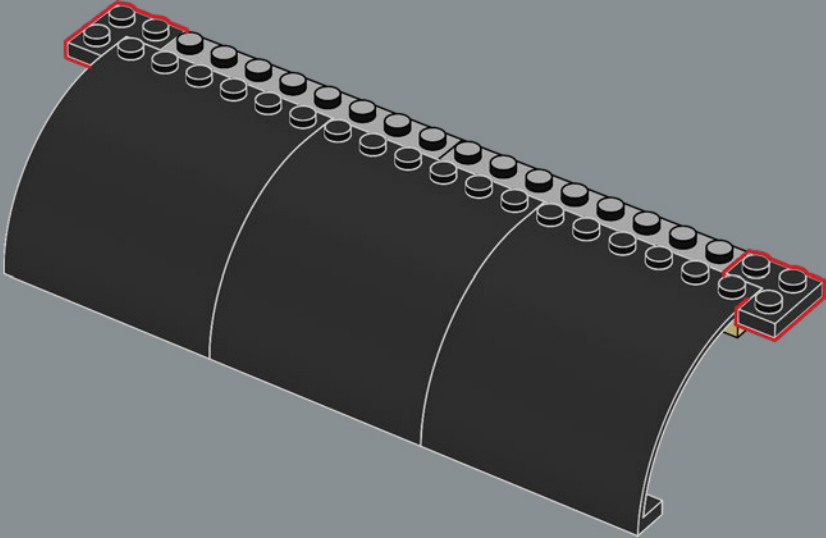

197

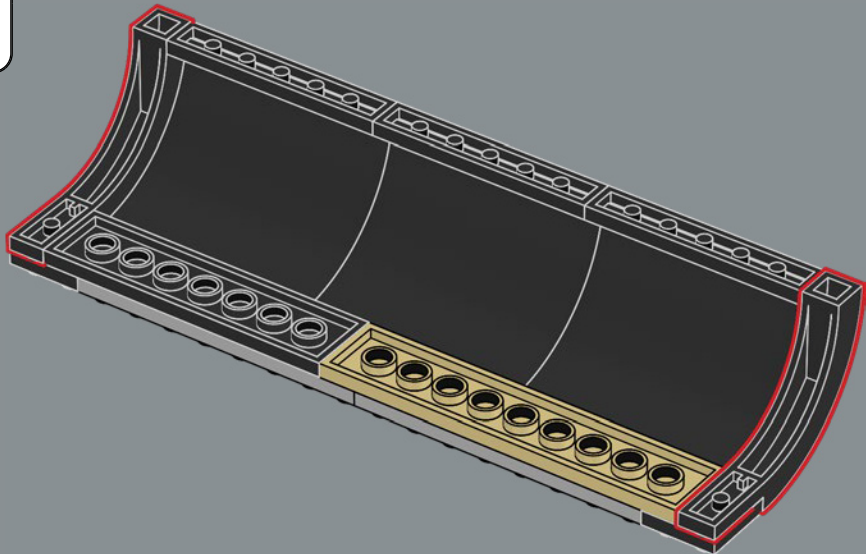

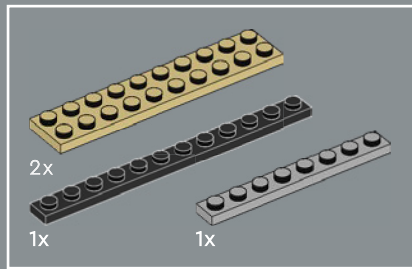

198

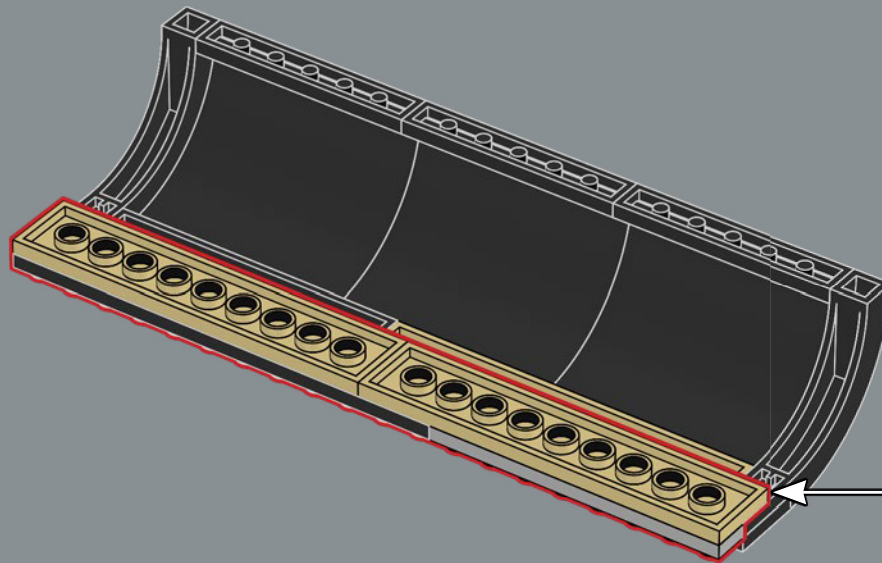
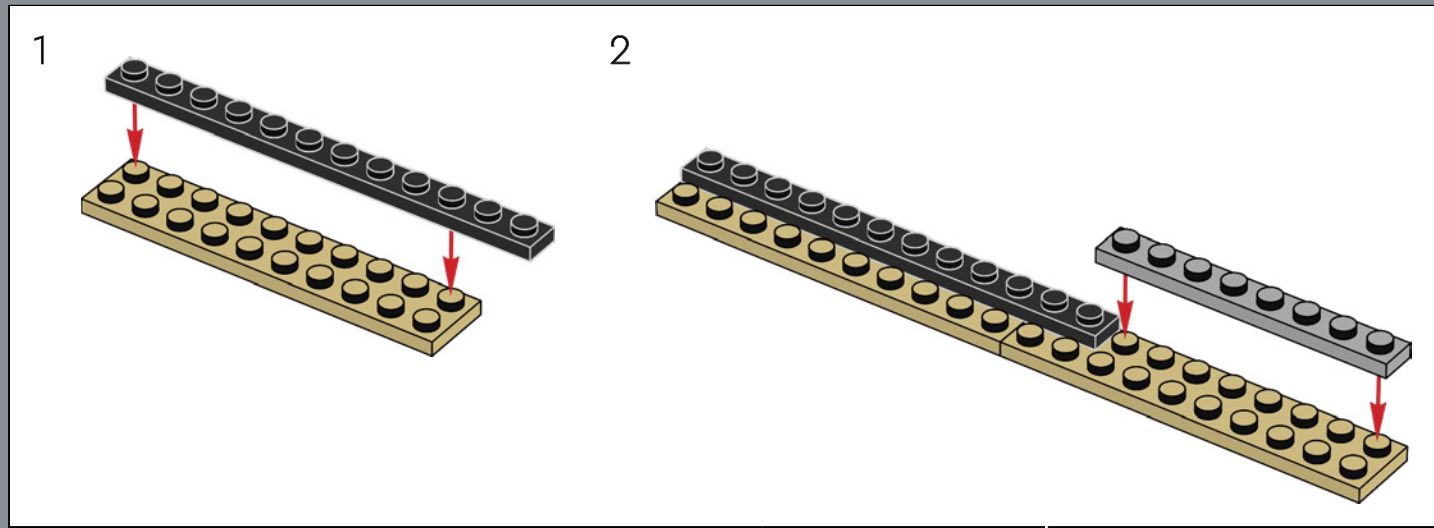



199

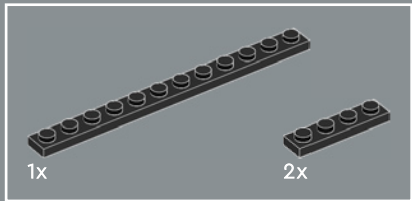
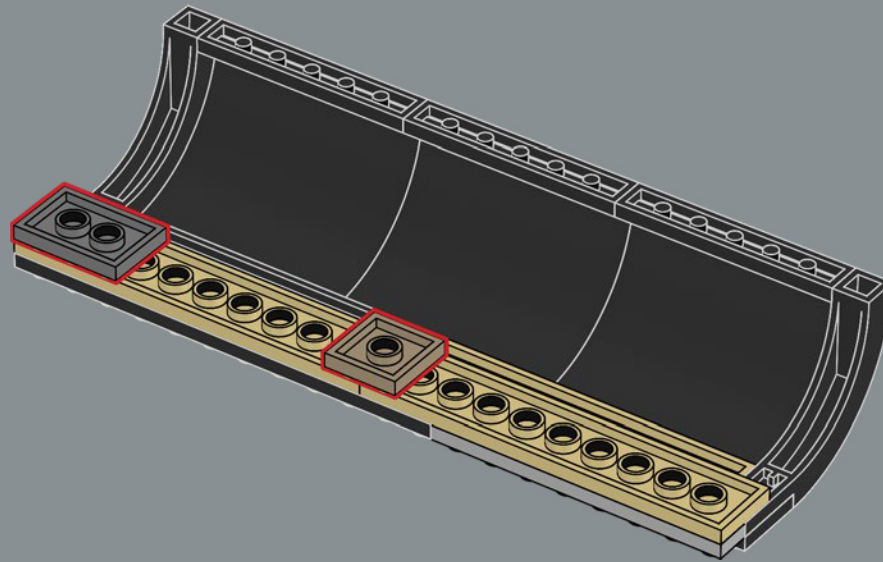

200

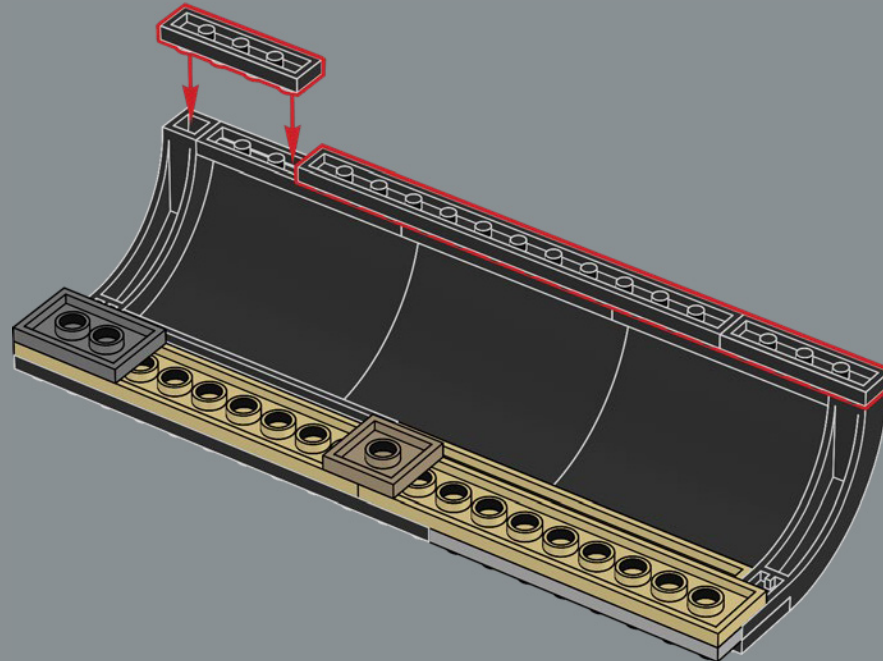

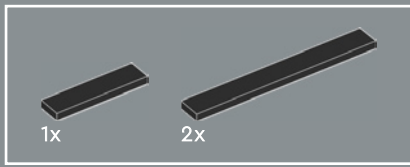

201

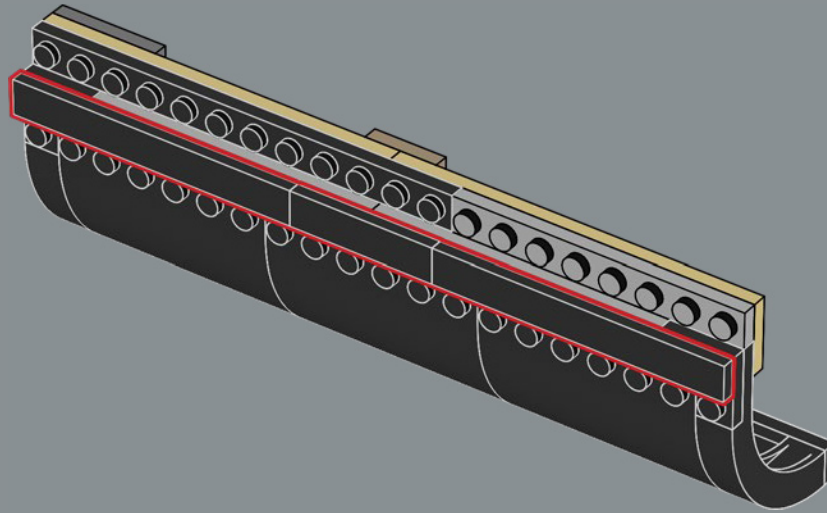

202

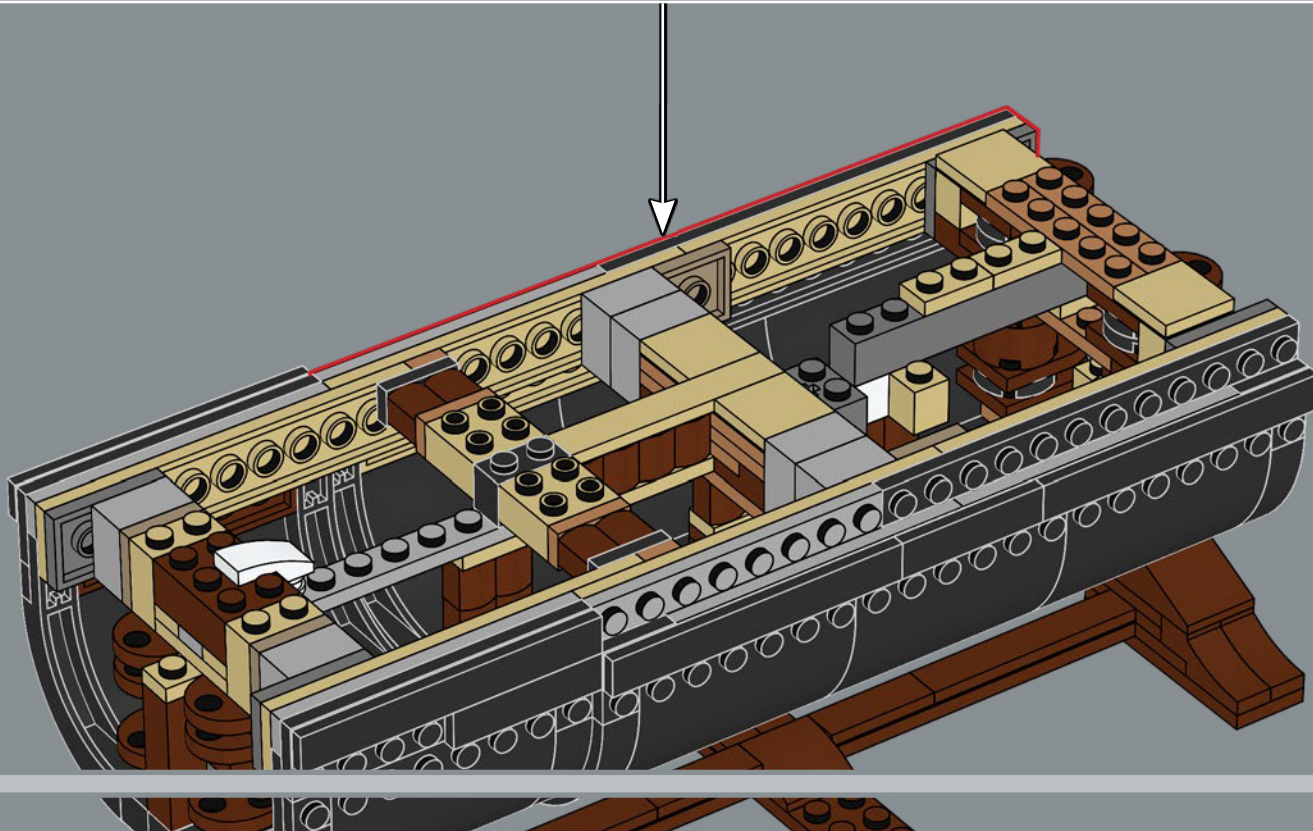

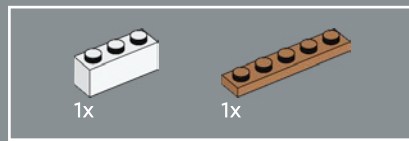
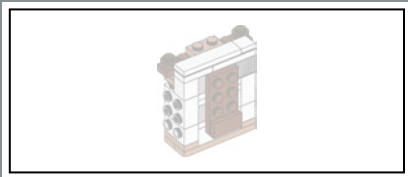

203

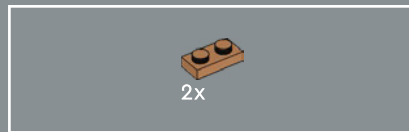
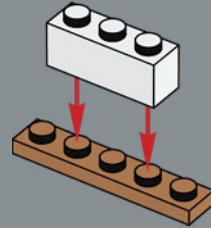

204

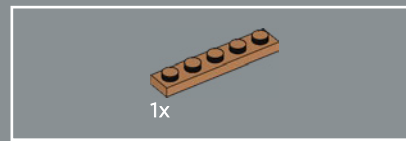
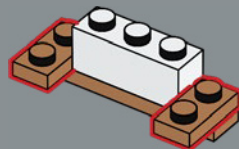

205

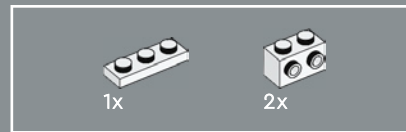
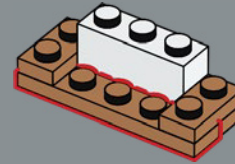

206

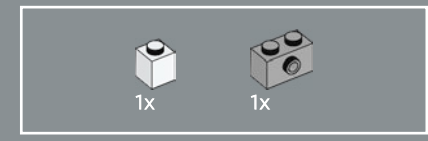
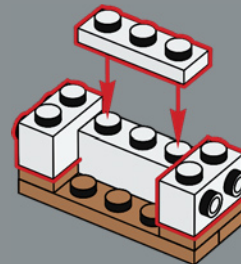

207

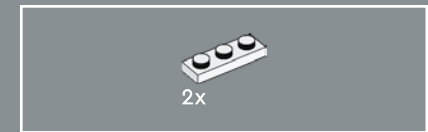
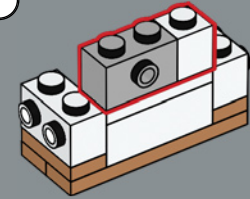

208

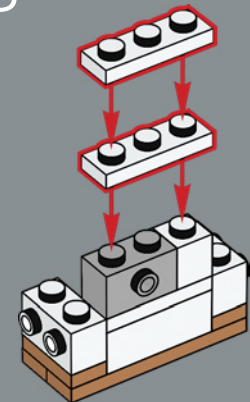

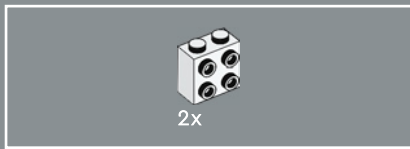

209

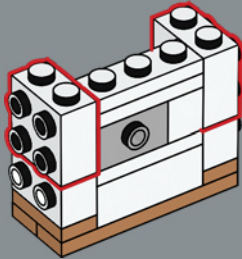

210

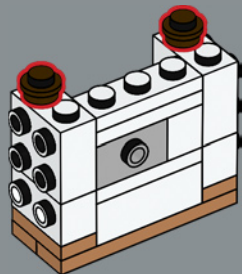

211

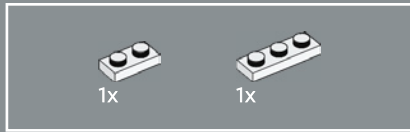
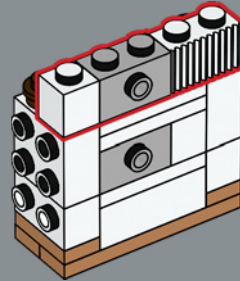

212

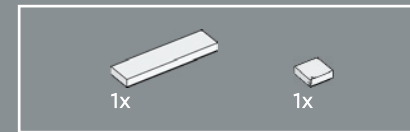
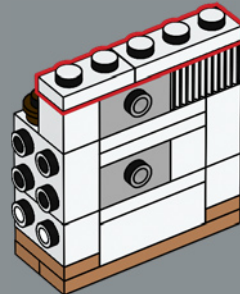

213

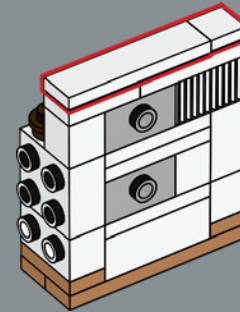

214

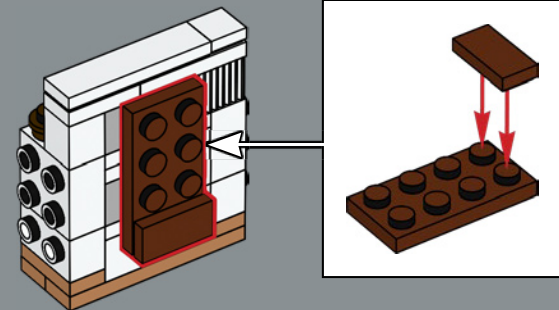

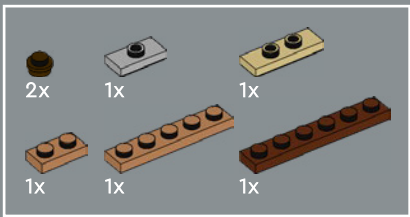

215

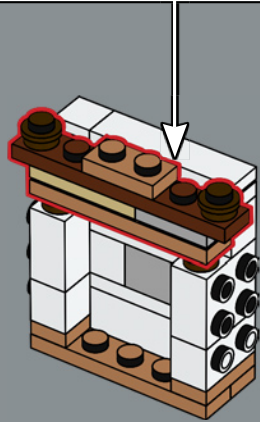
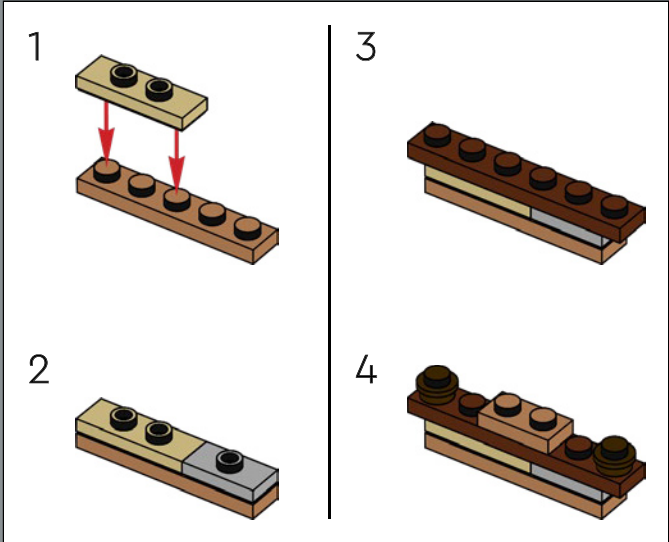

216

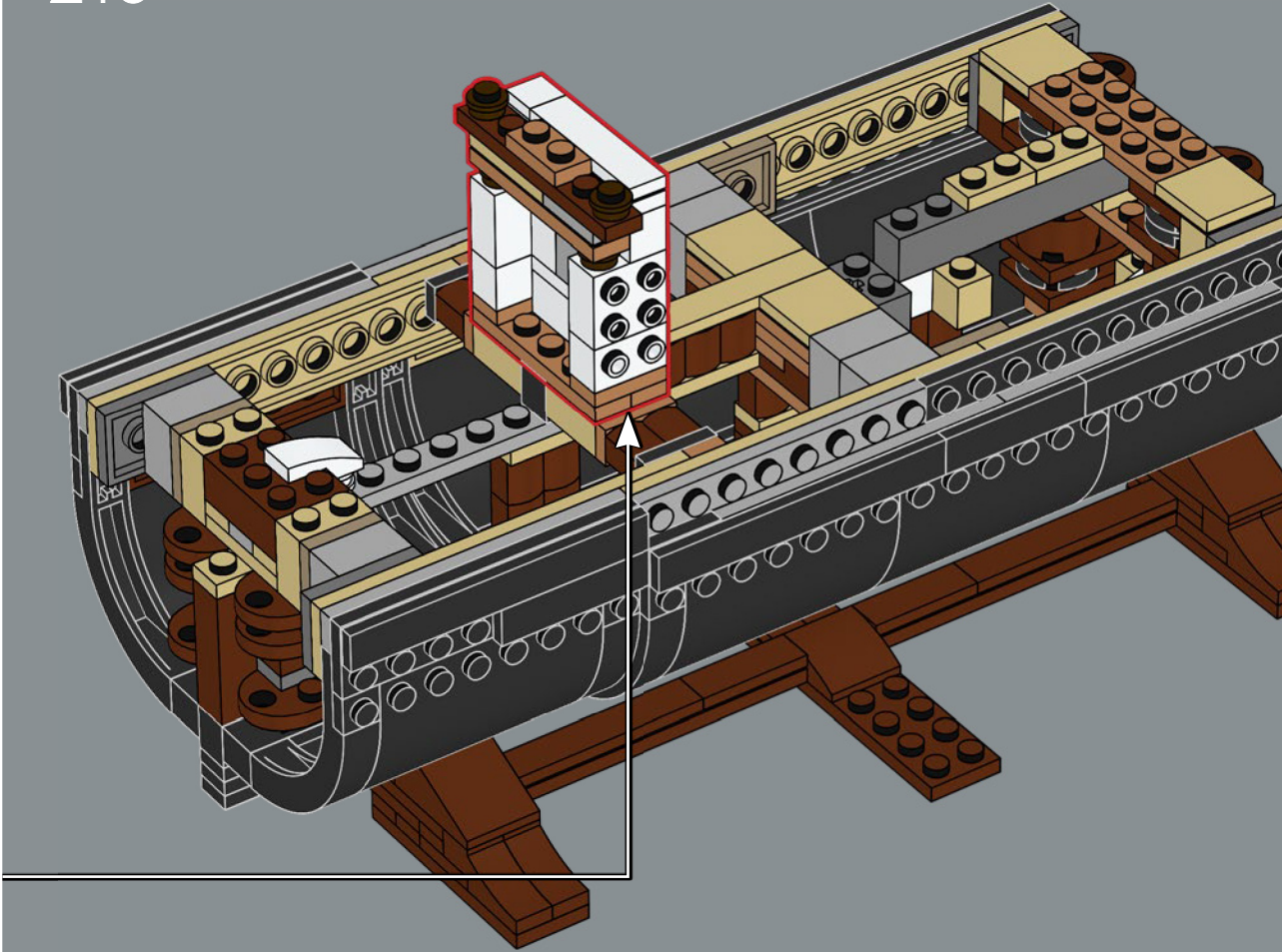

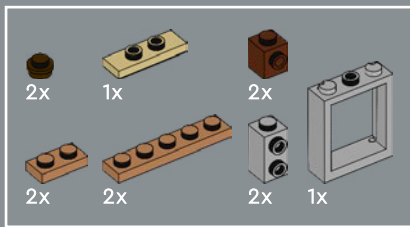

217

1

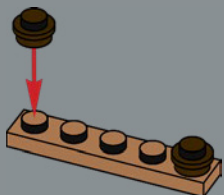

2

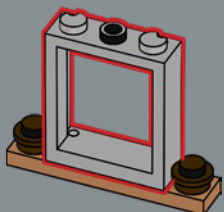

3

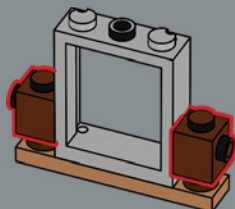

4

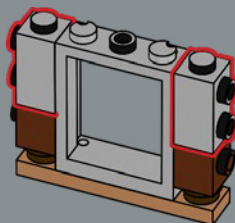

5

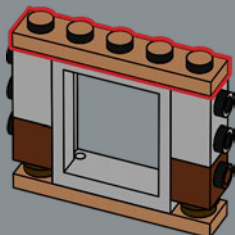

6

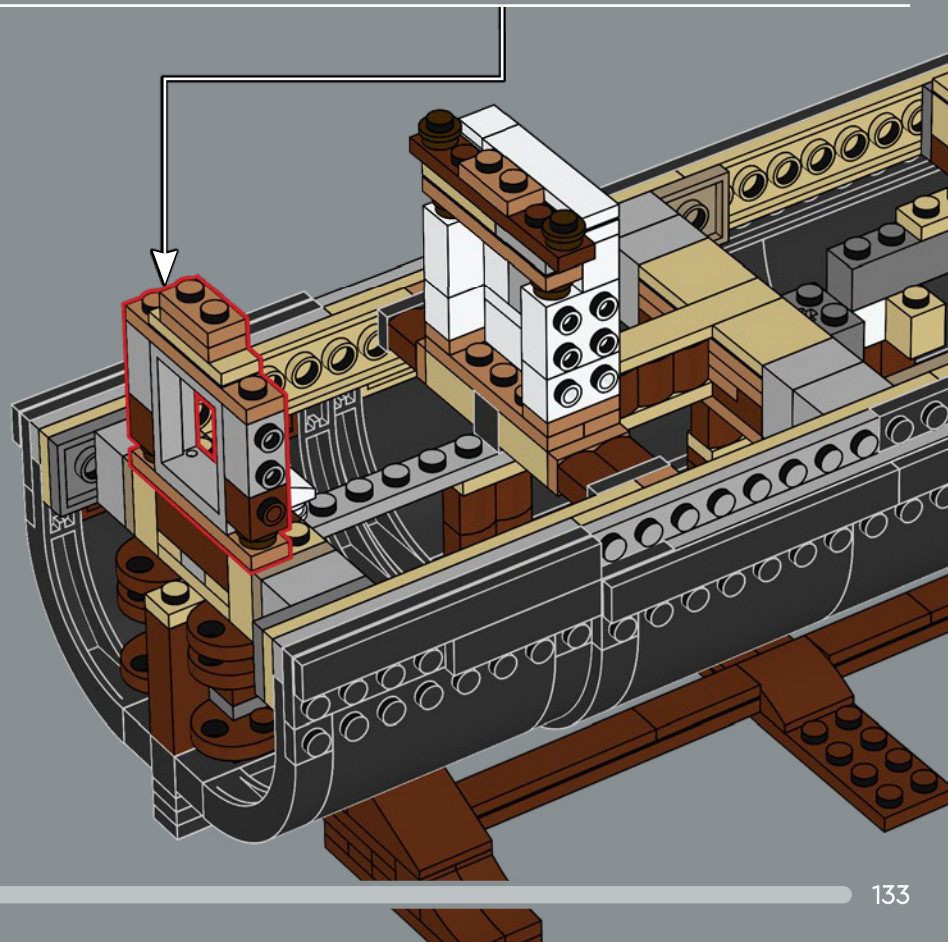
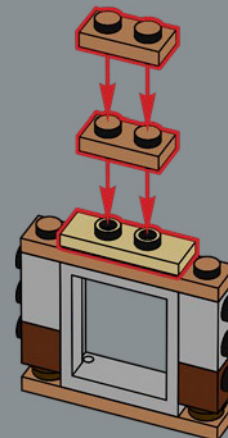

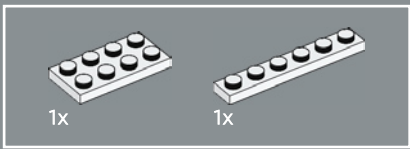

218

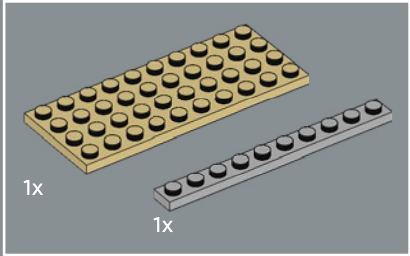
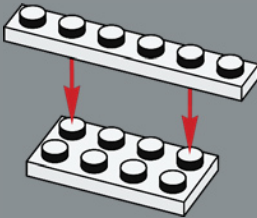

219

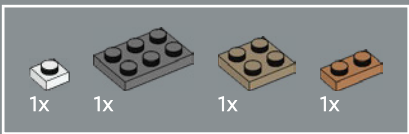
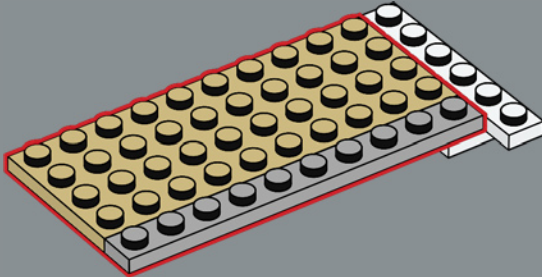

220

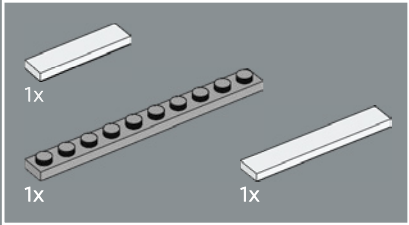
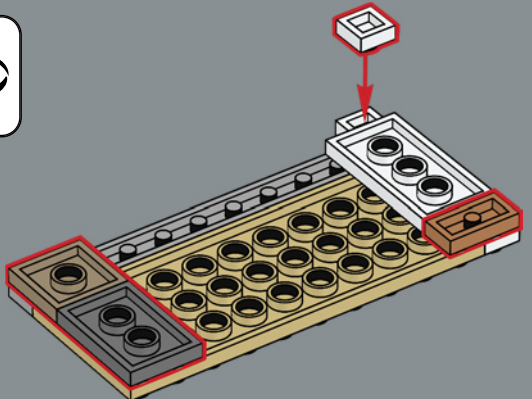

221

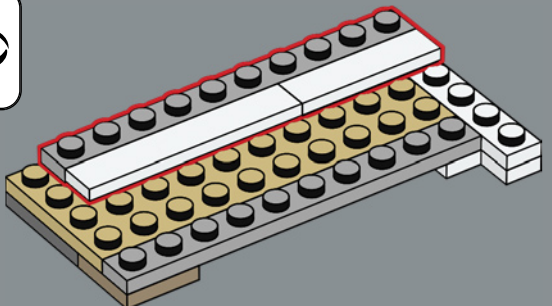

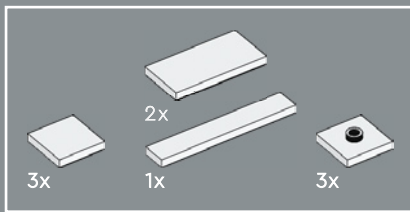

222

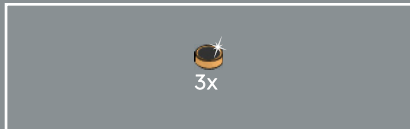
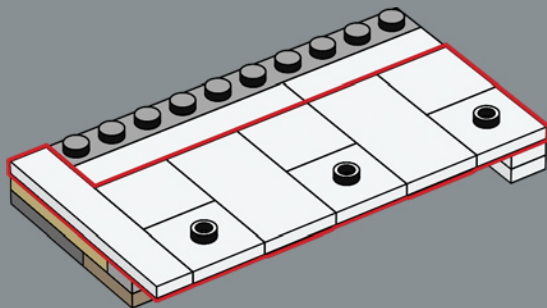

223

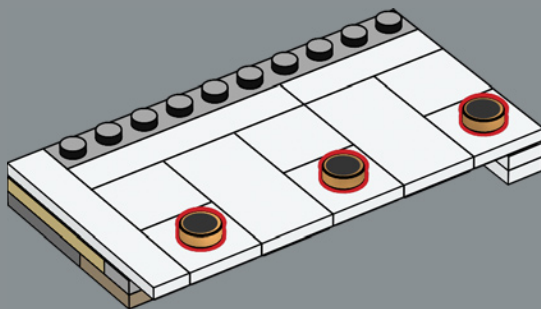

224

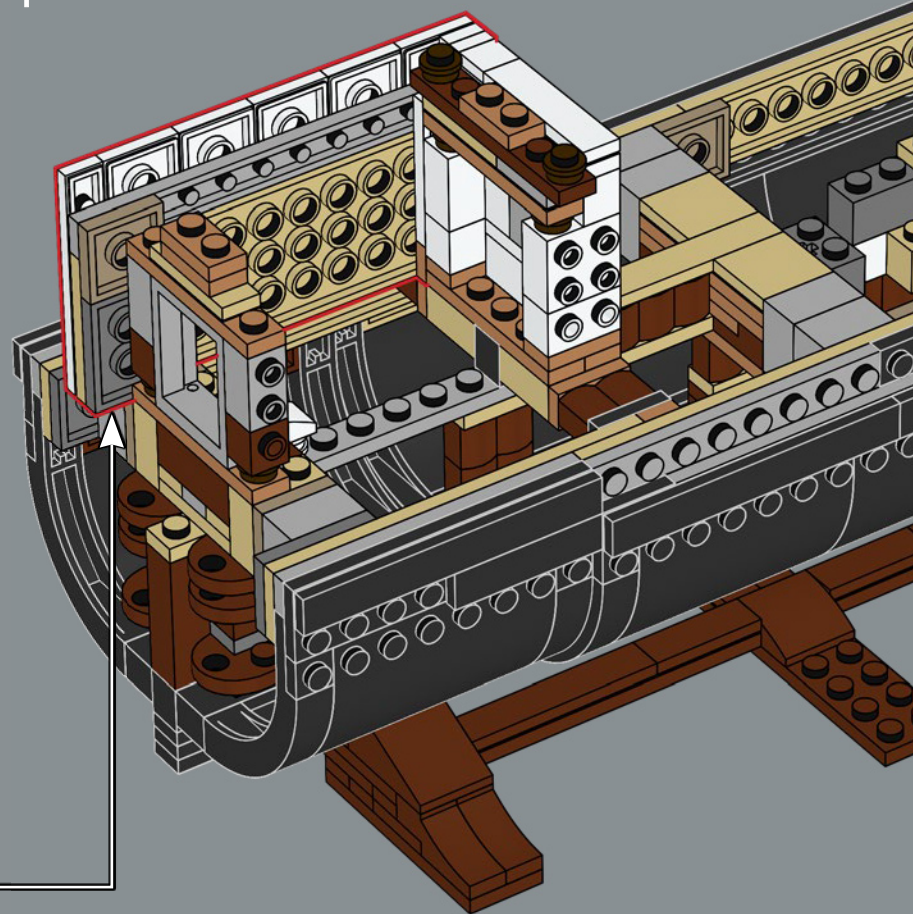

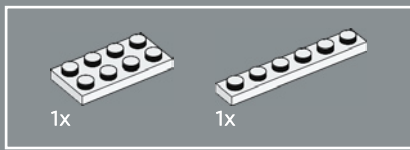

225

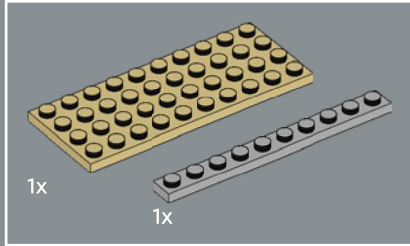
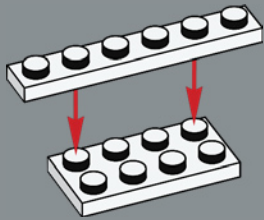

226

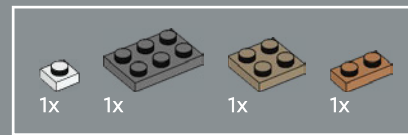
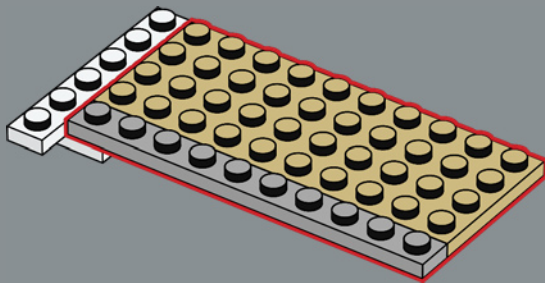

227

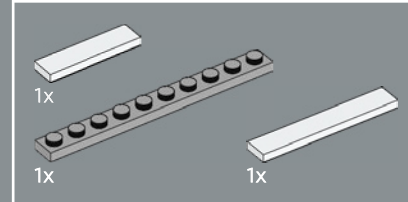
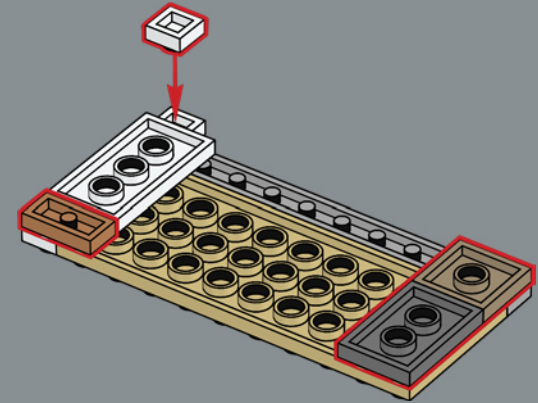

228

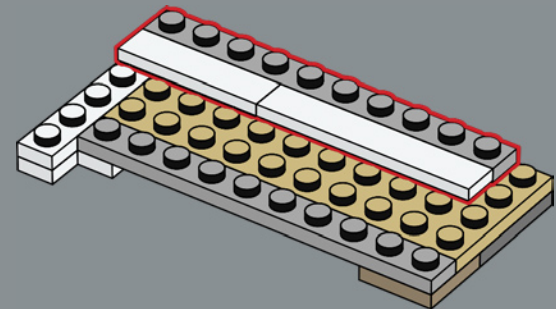

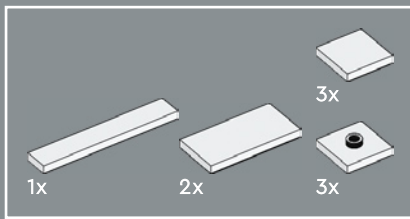

229

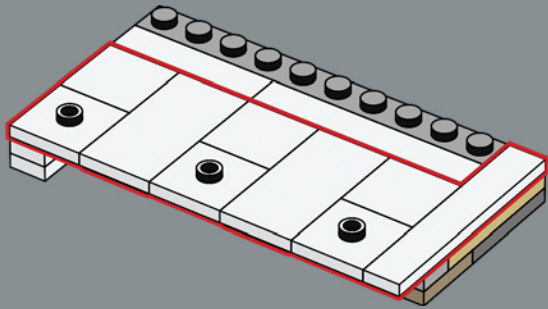

230

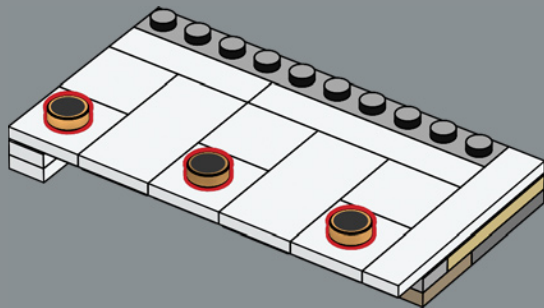

231

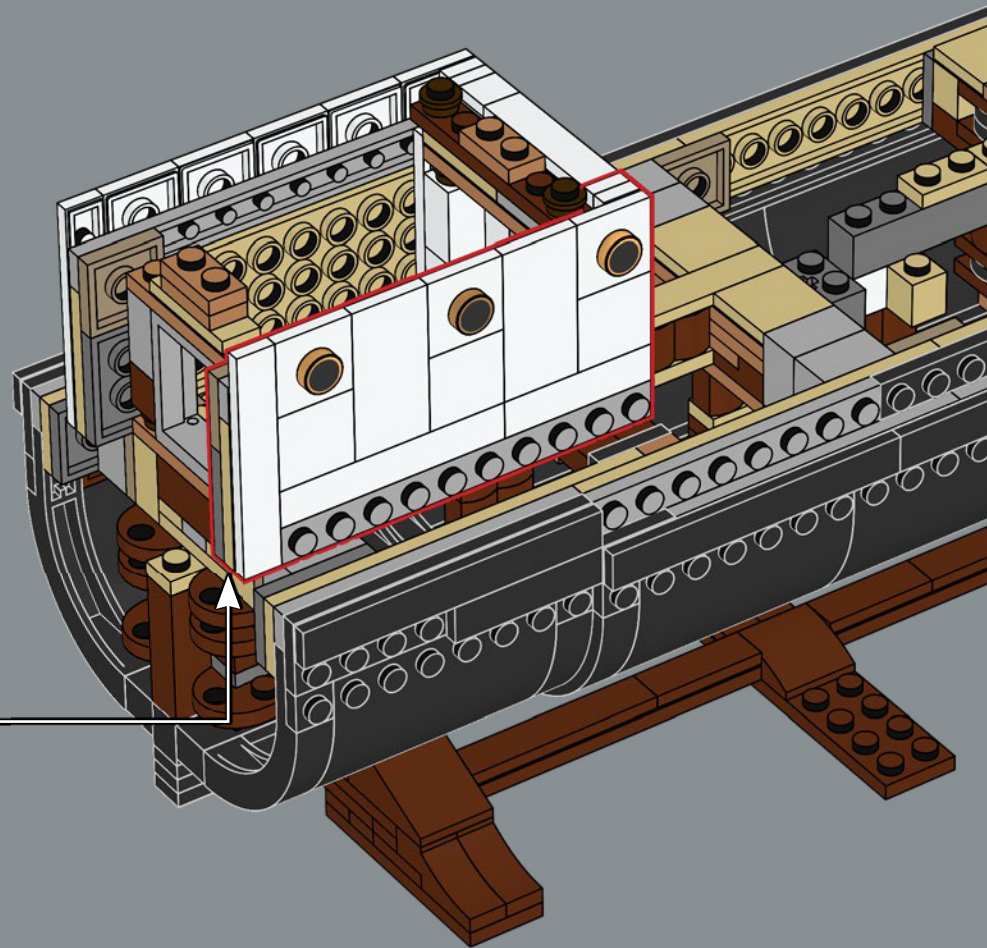



1

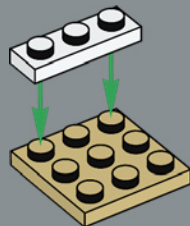

2



3

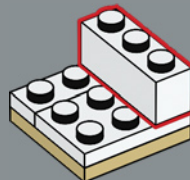

4

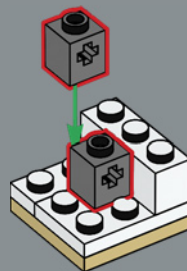

5

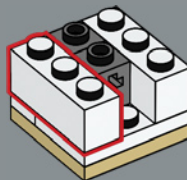

6

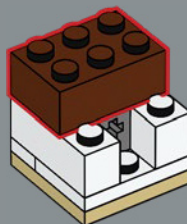

7

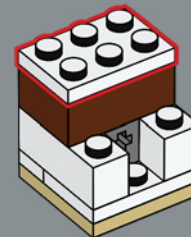

8

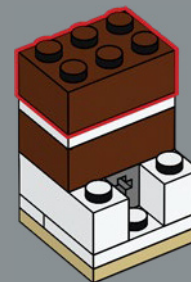

9

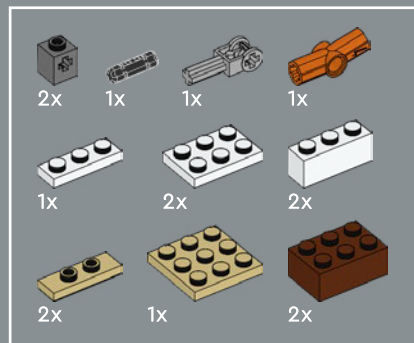
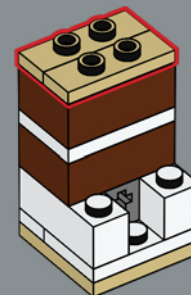

232

10

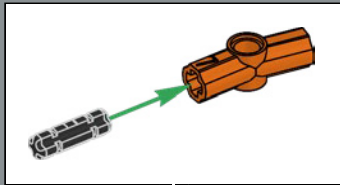
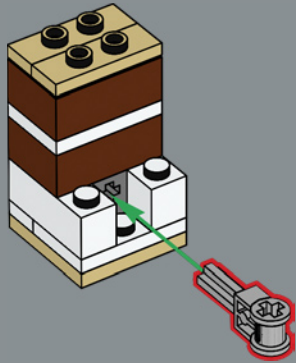

11

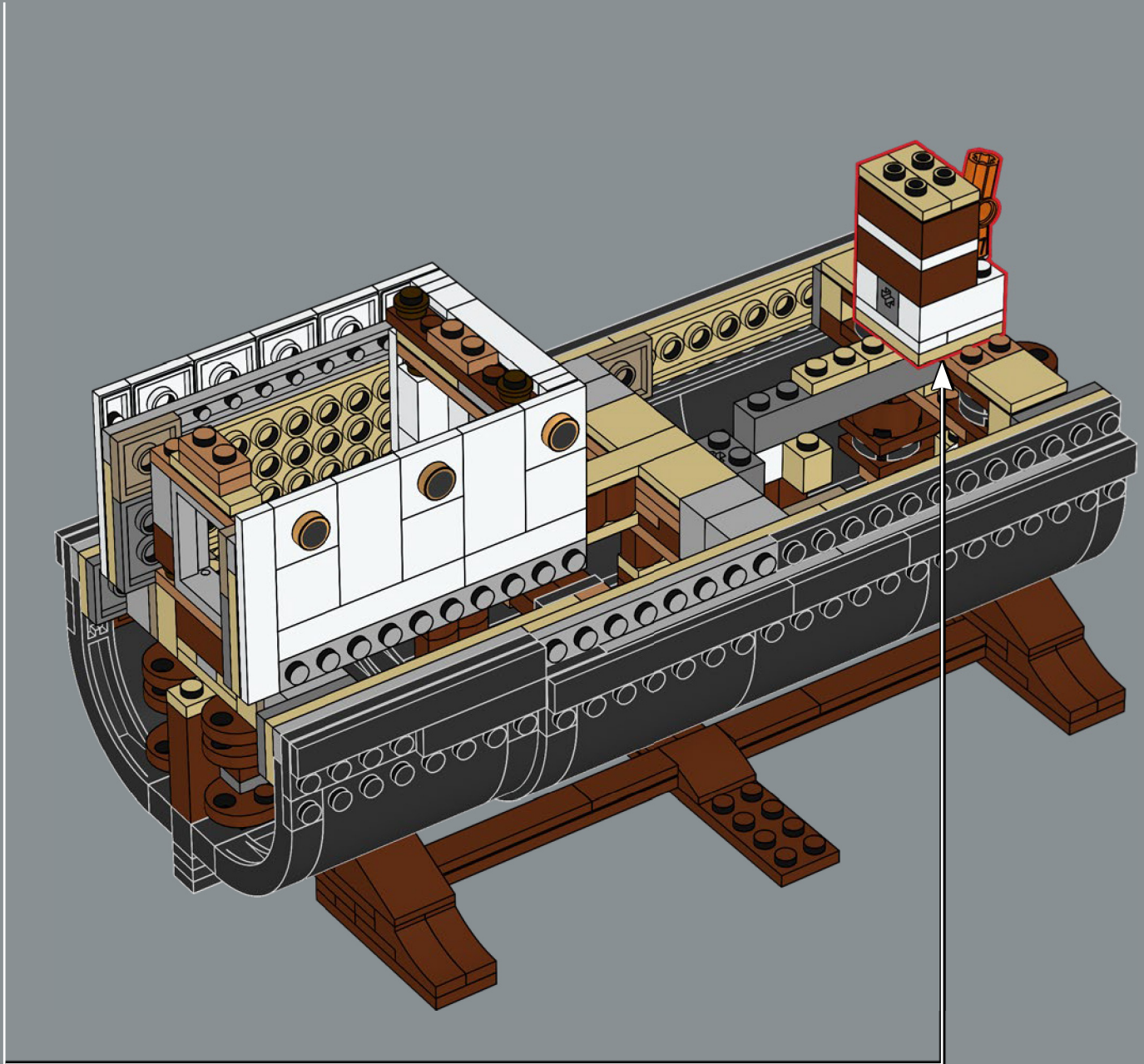
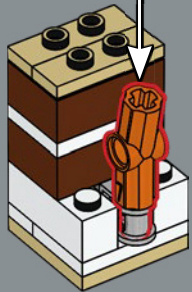

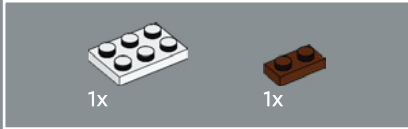
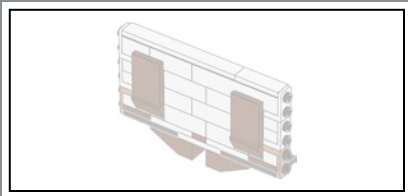

233

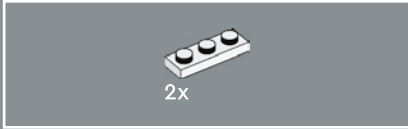
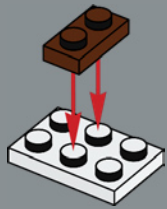

234

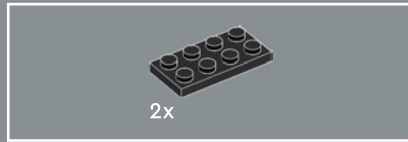
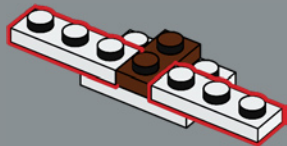

235

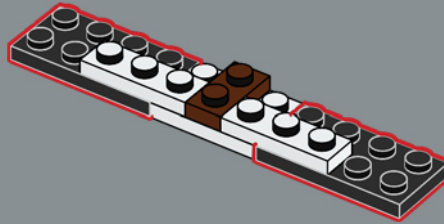

236

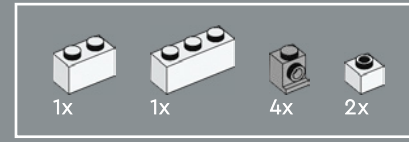
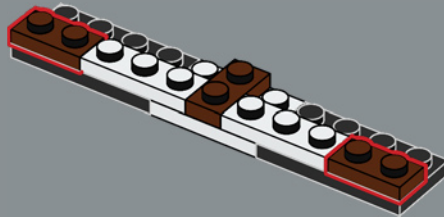

237

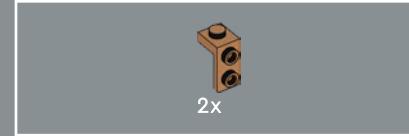
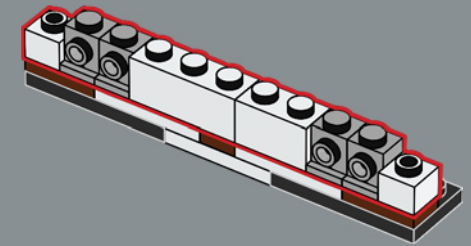

238

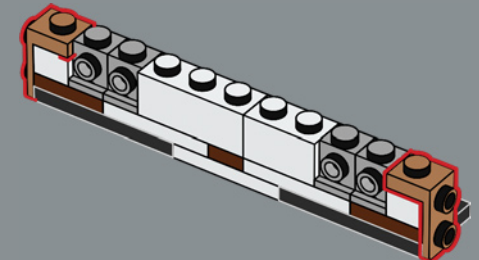

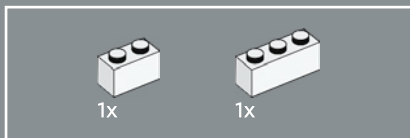

239

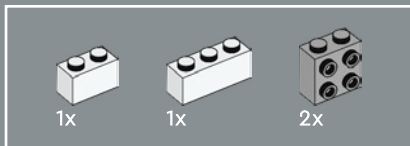
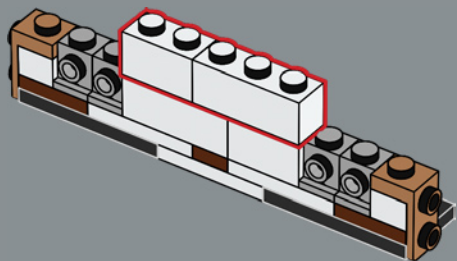

240

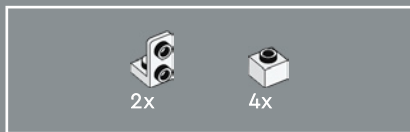
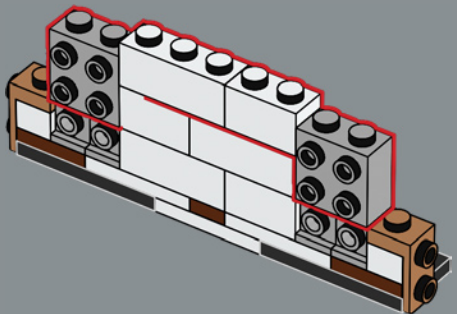

241

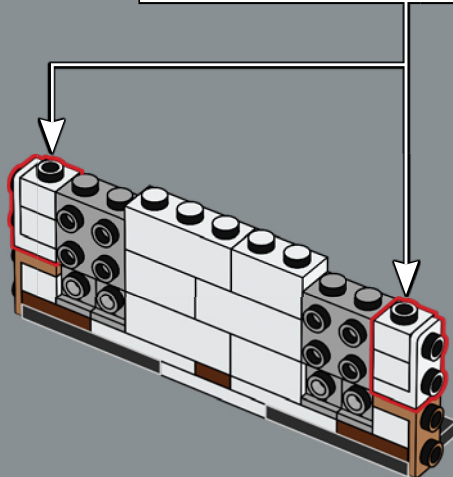
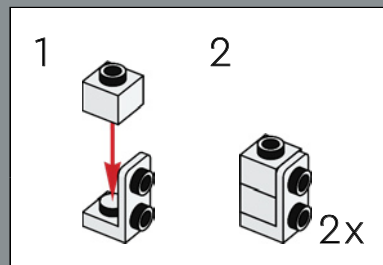

242

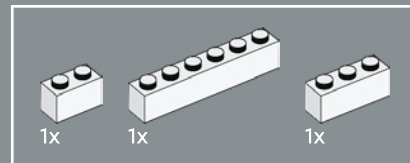
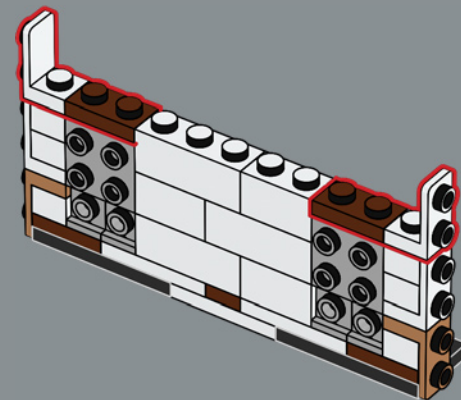

243

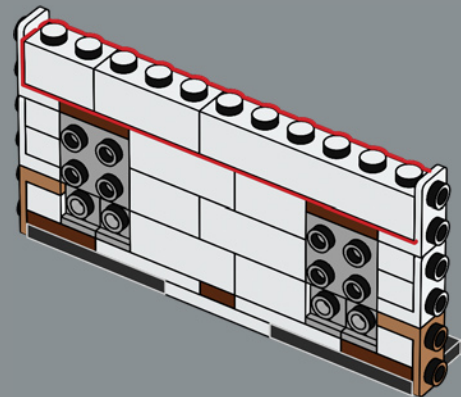

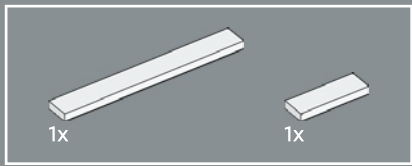

244

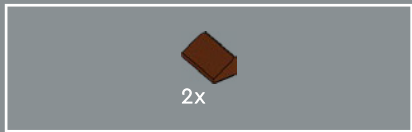
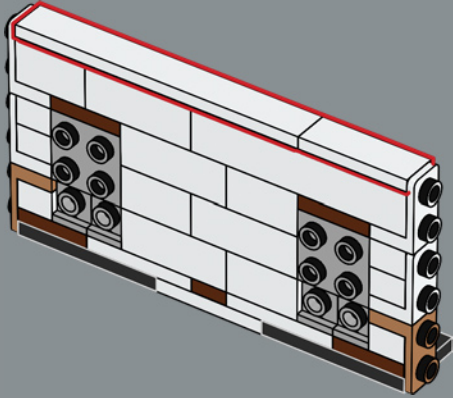

245

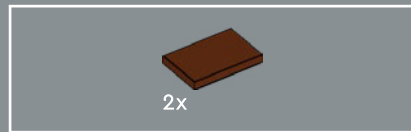
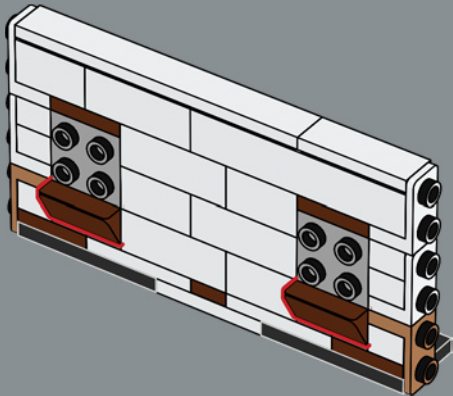

246

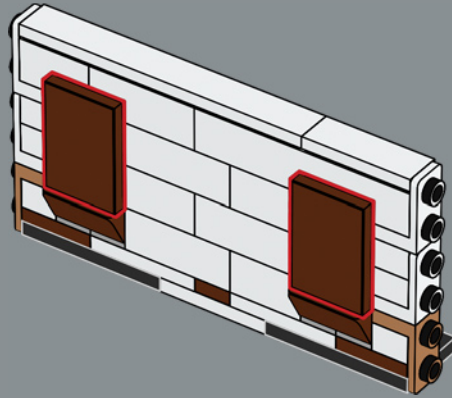

247

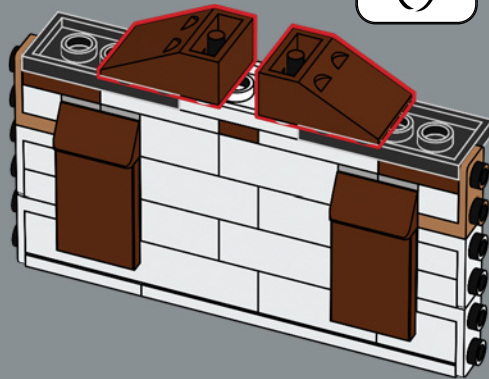

248

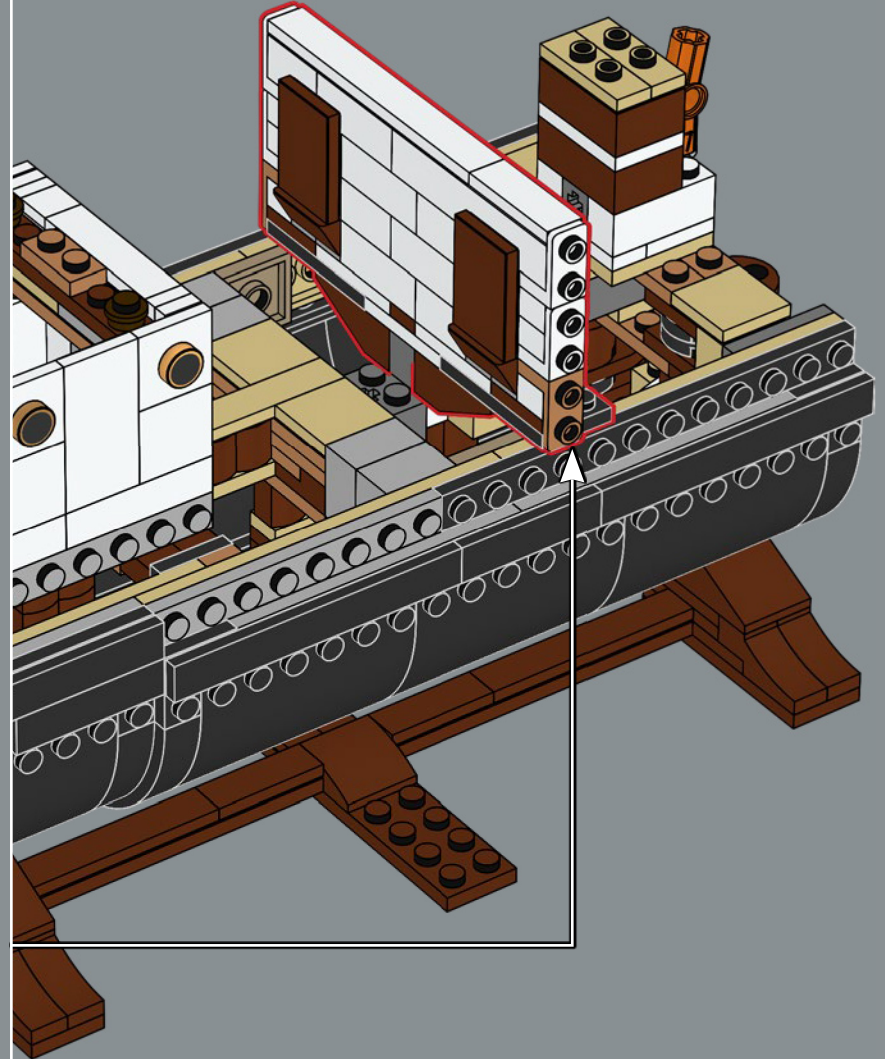

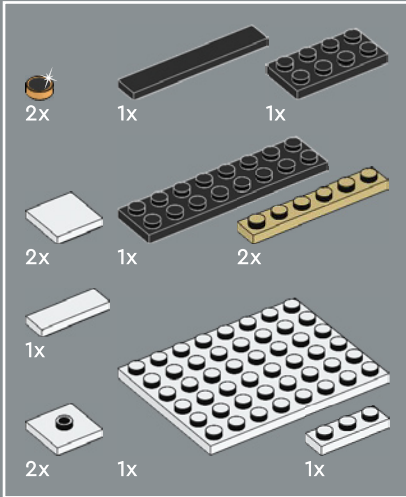
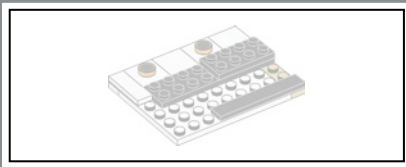

249

1

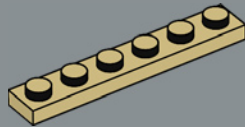

2

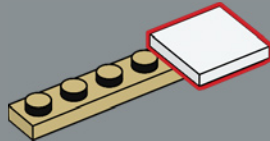

3

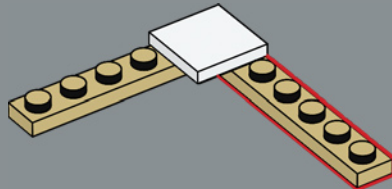

4

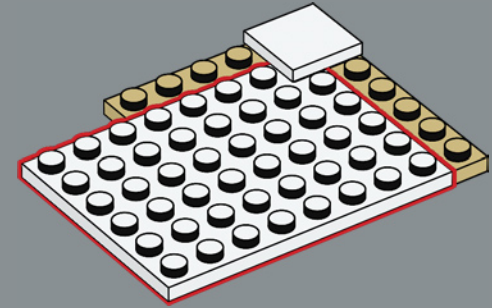

5

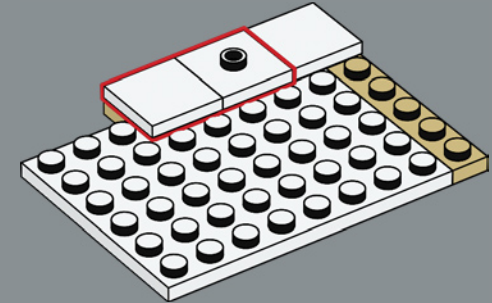

6

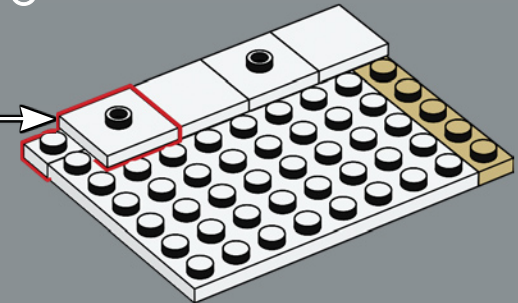
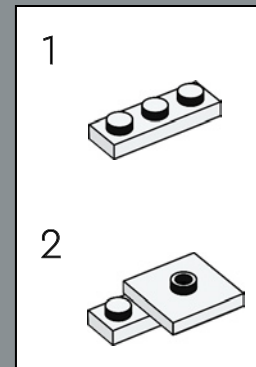

7

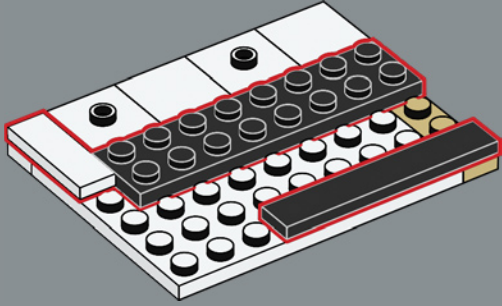

8

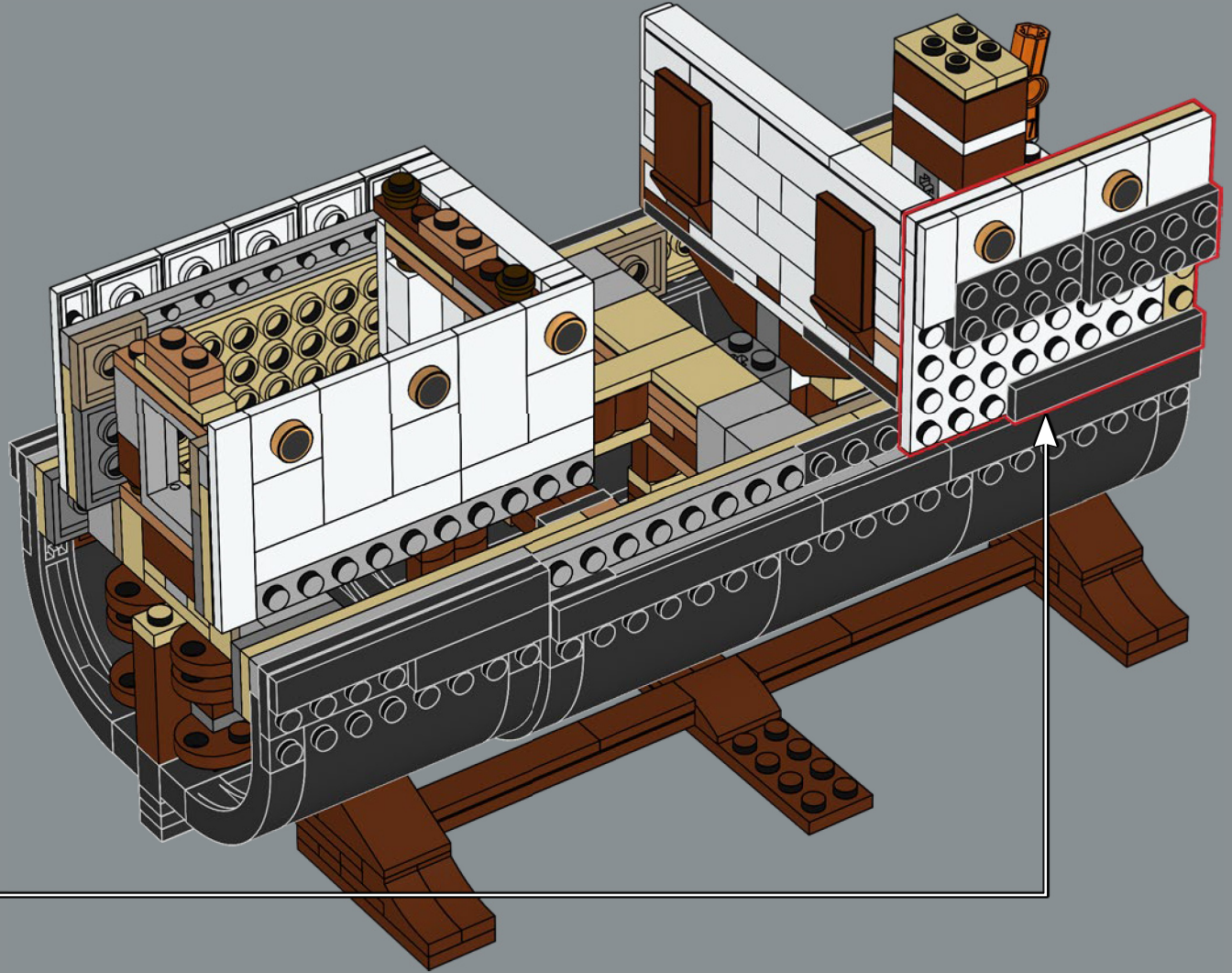
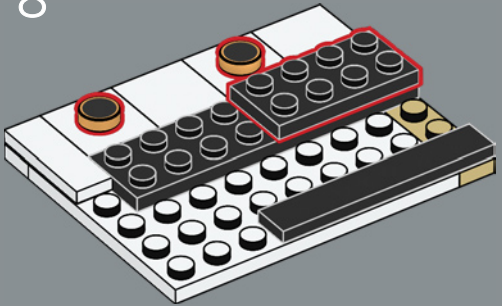

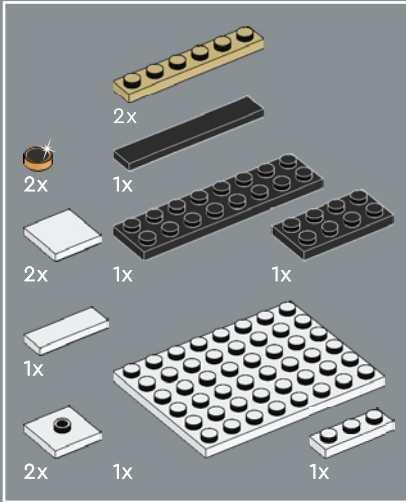
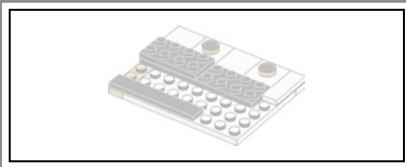

250

1

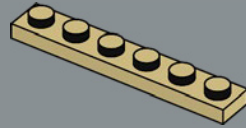

2

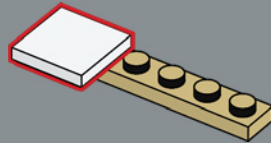

3

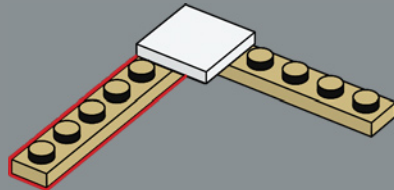

4

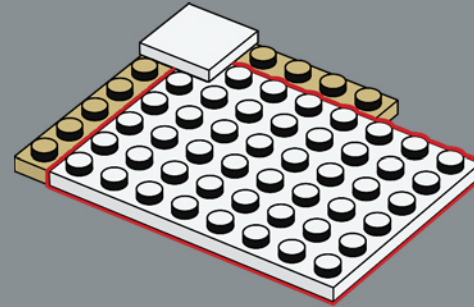

5

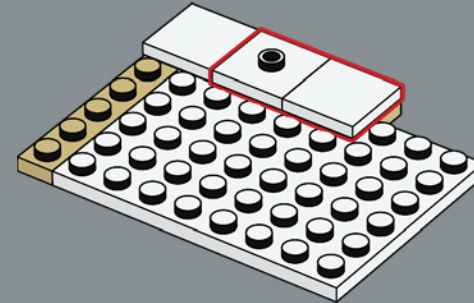

6

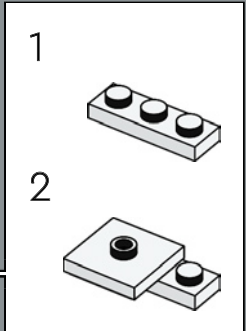
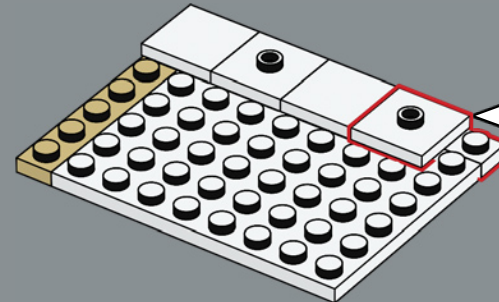

7

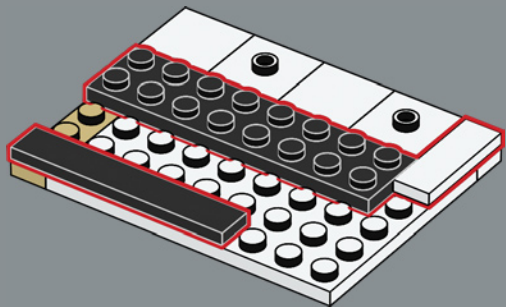

8

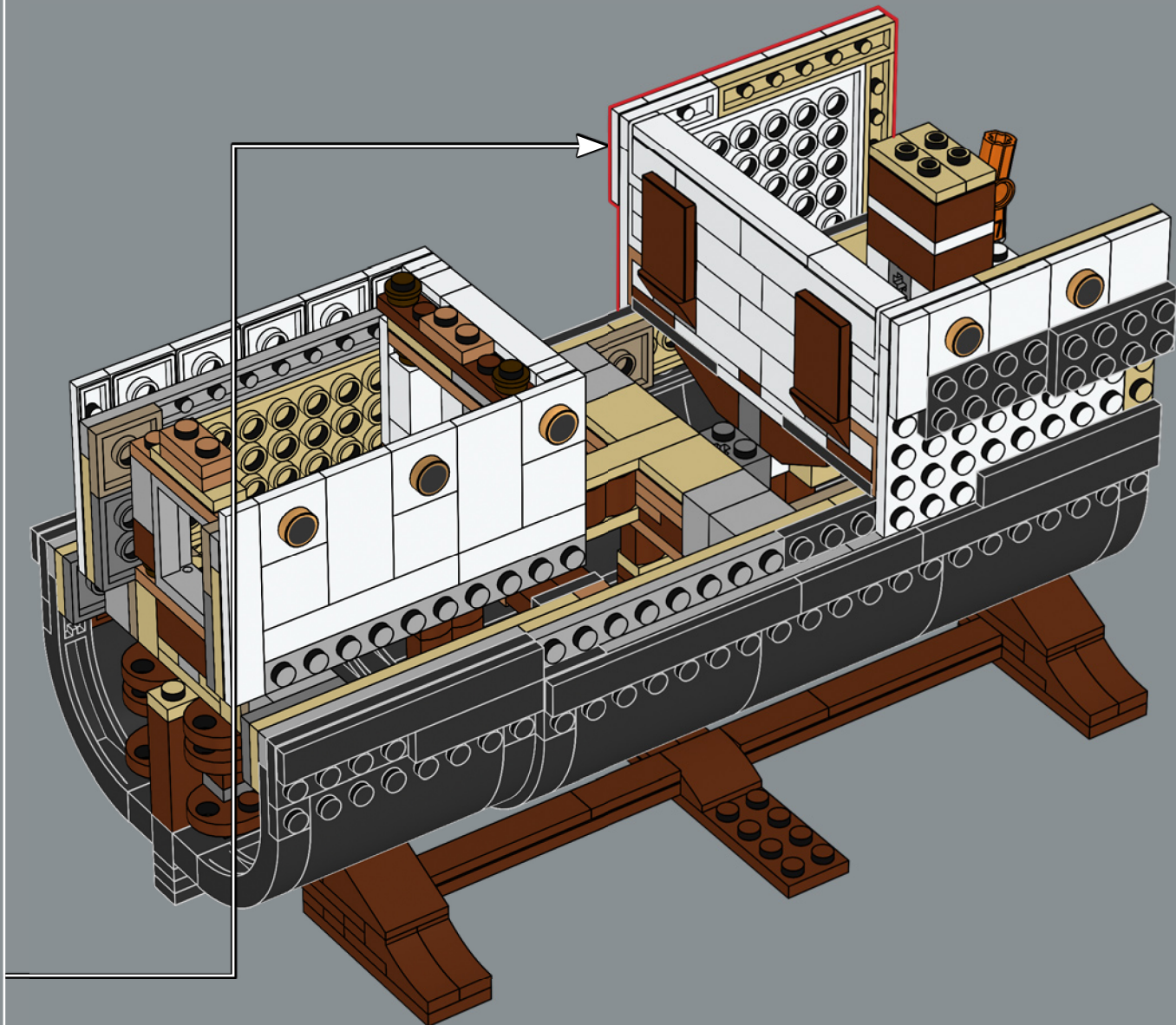
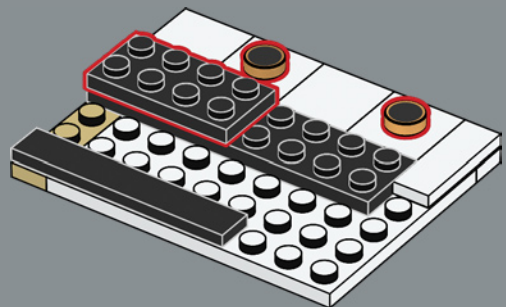

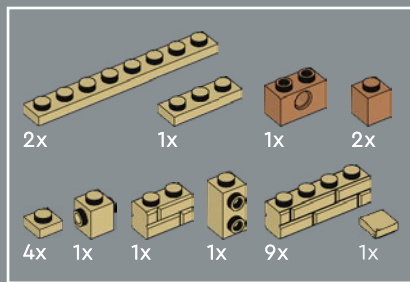
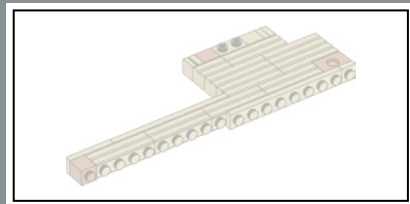

251

1

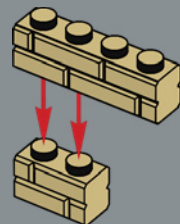

2

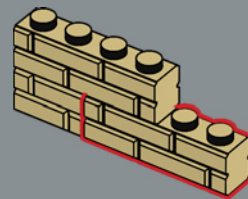

3

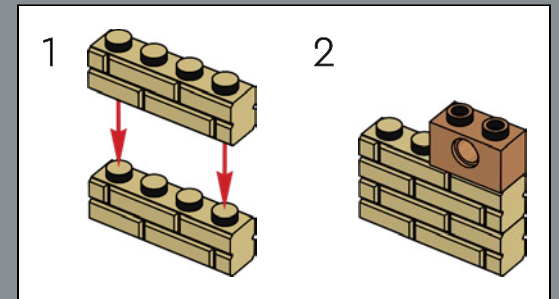
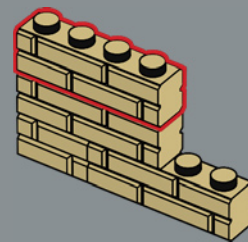

4

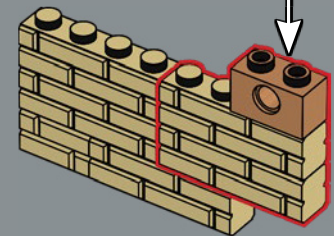

5

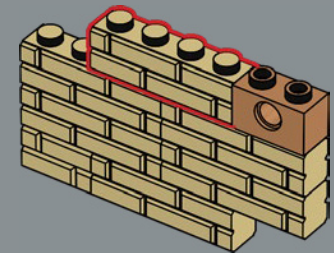

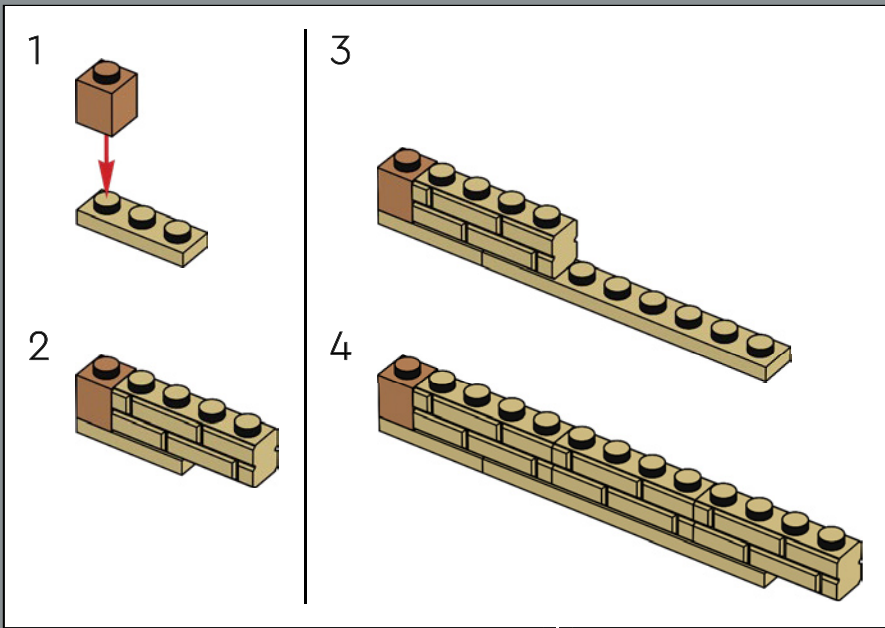

6

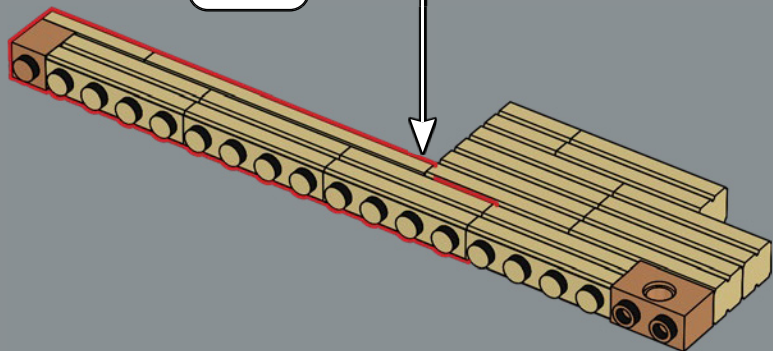

7

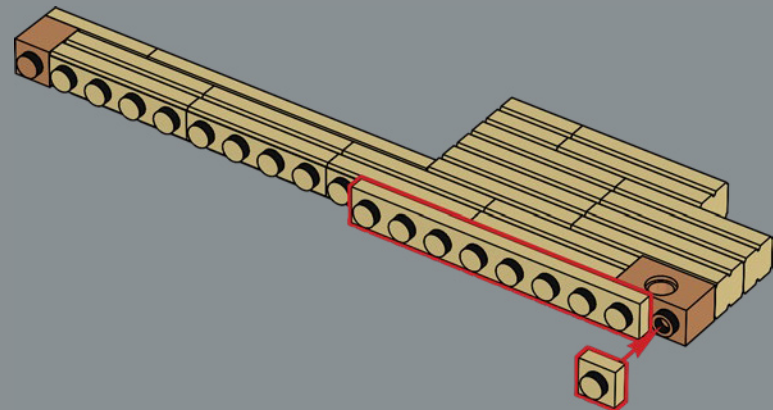

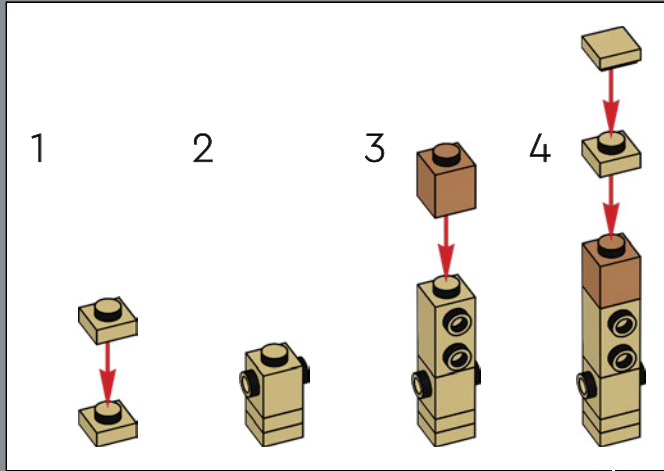

8

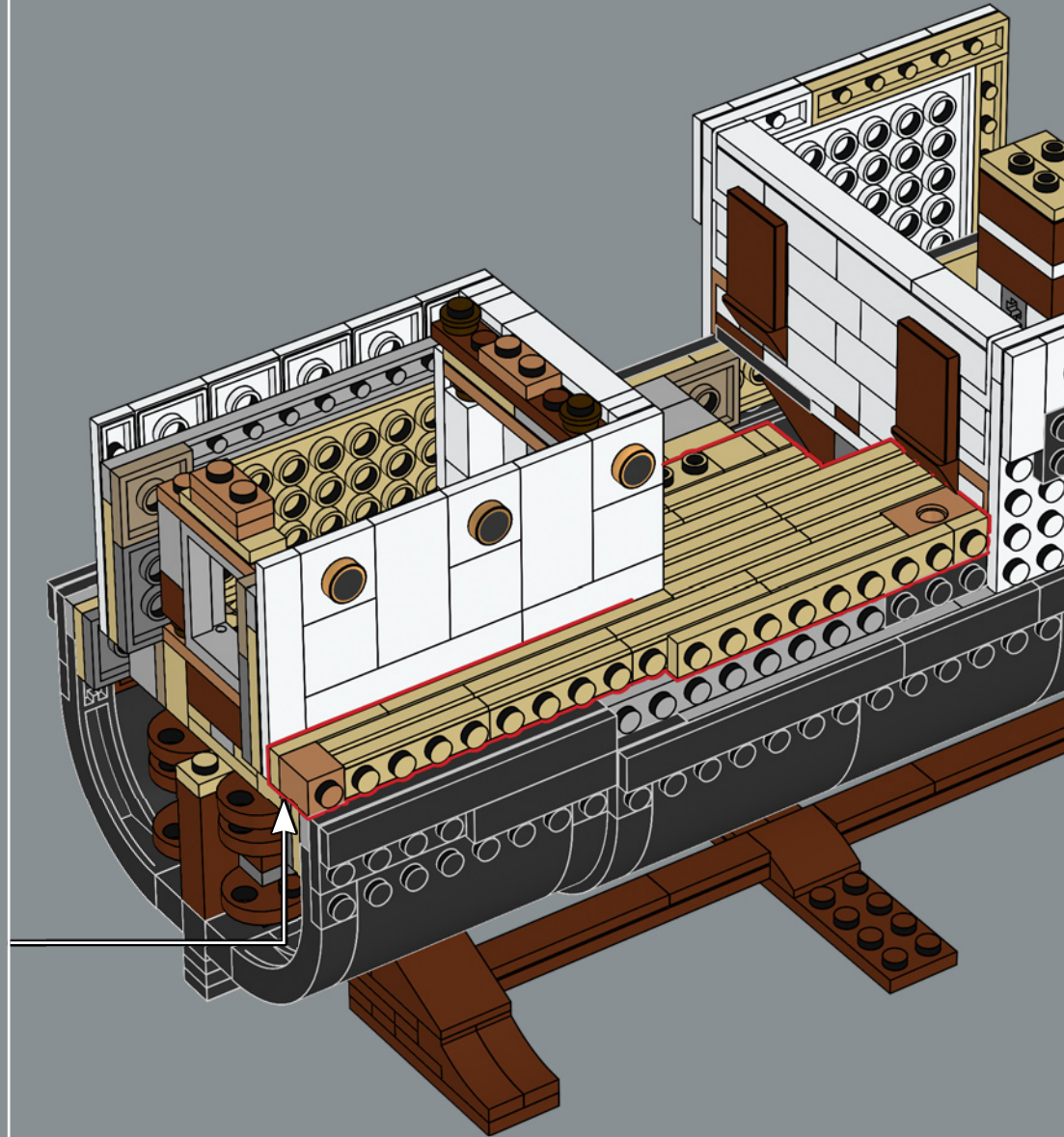
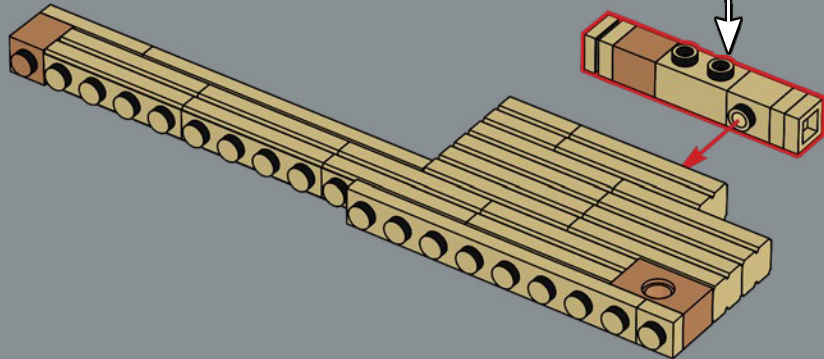

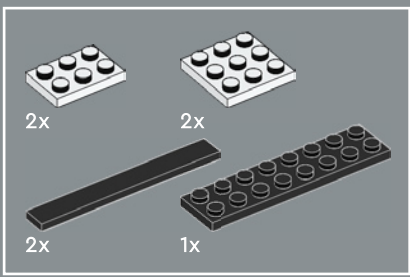

252

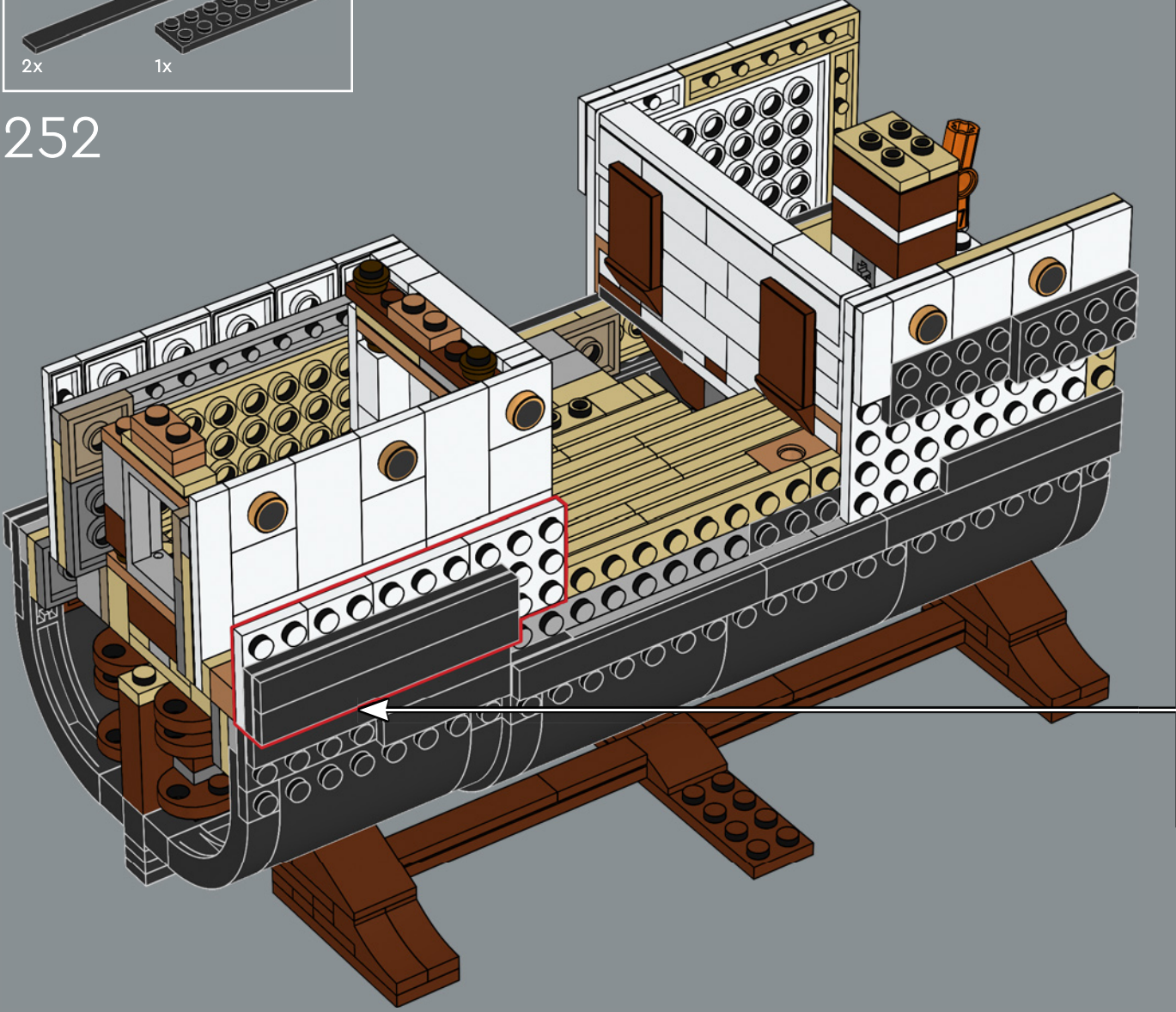

1

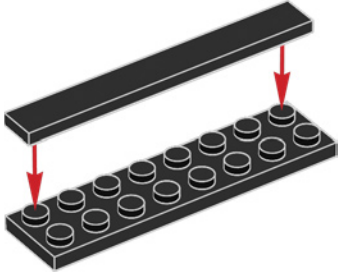

2

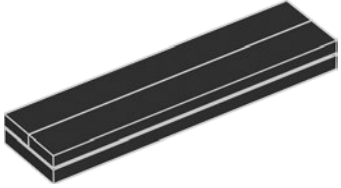

3

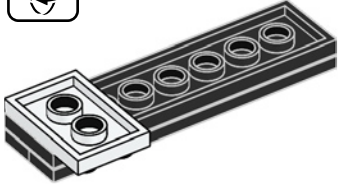

4

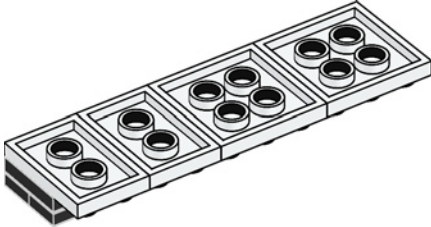

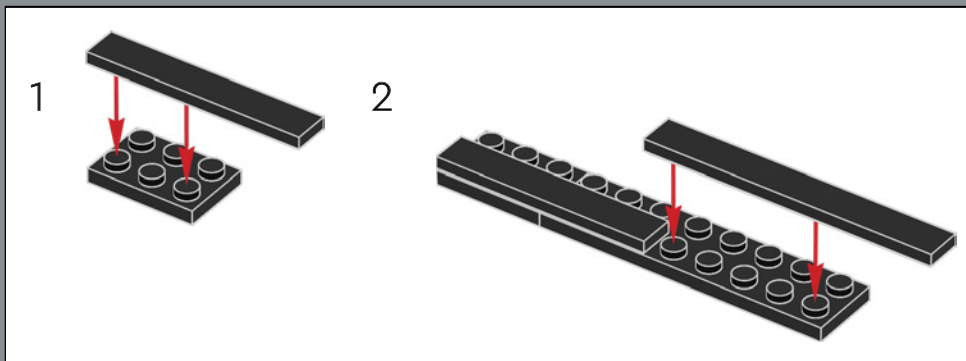
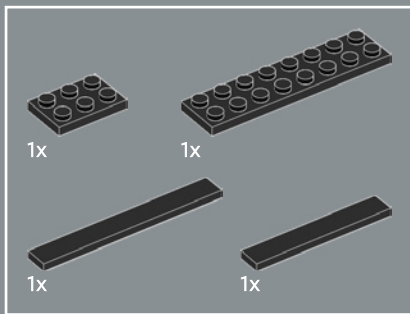

253

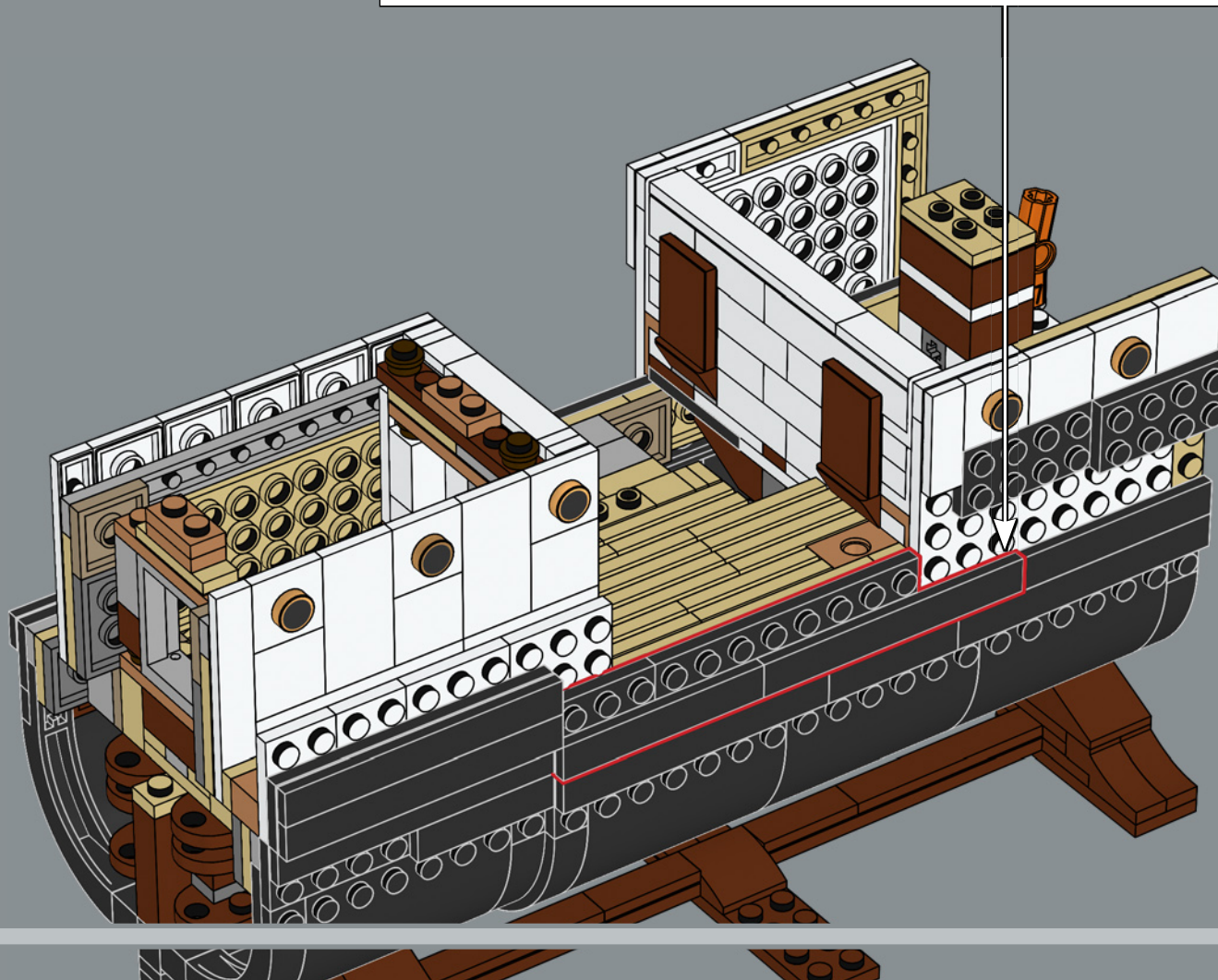

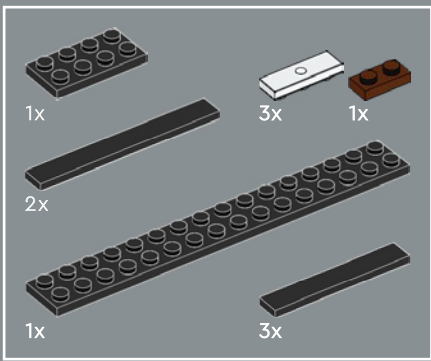

254

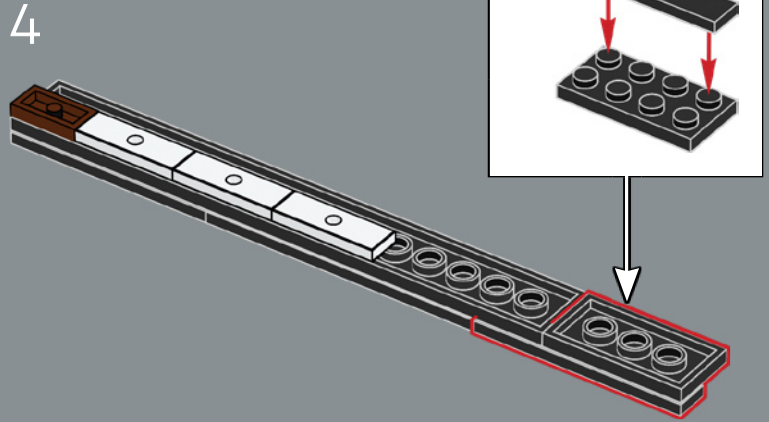
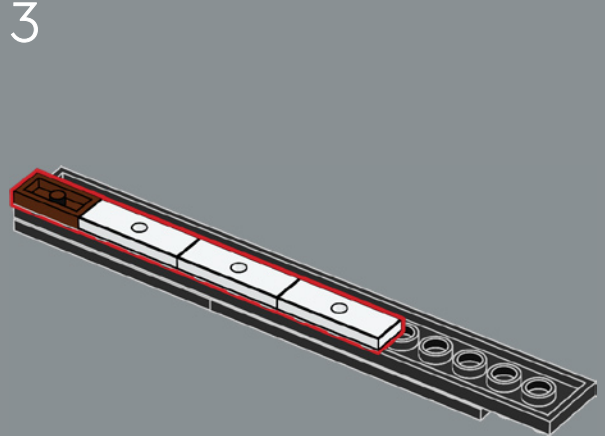
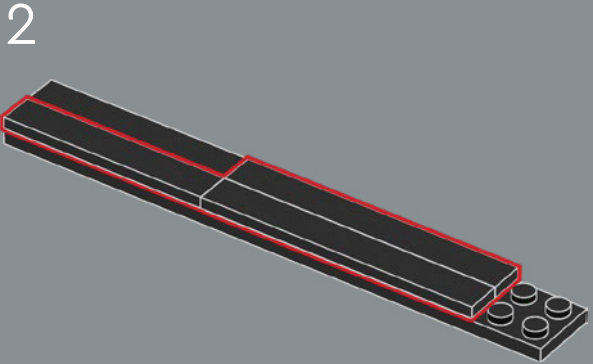
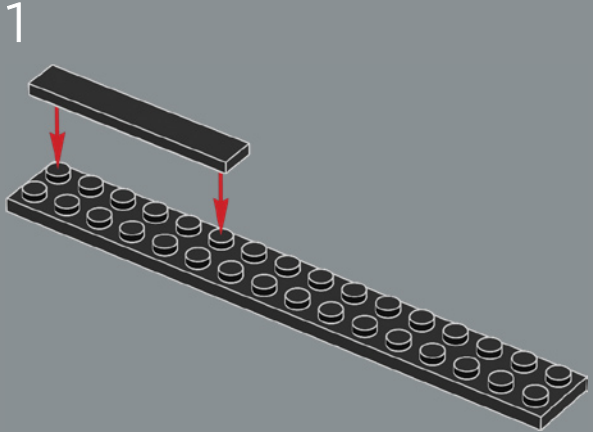

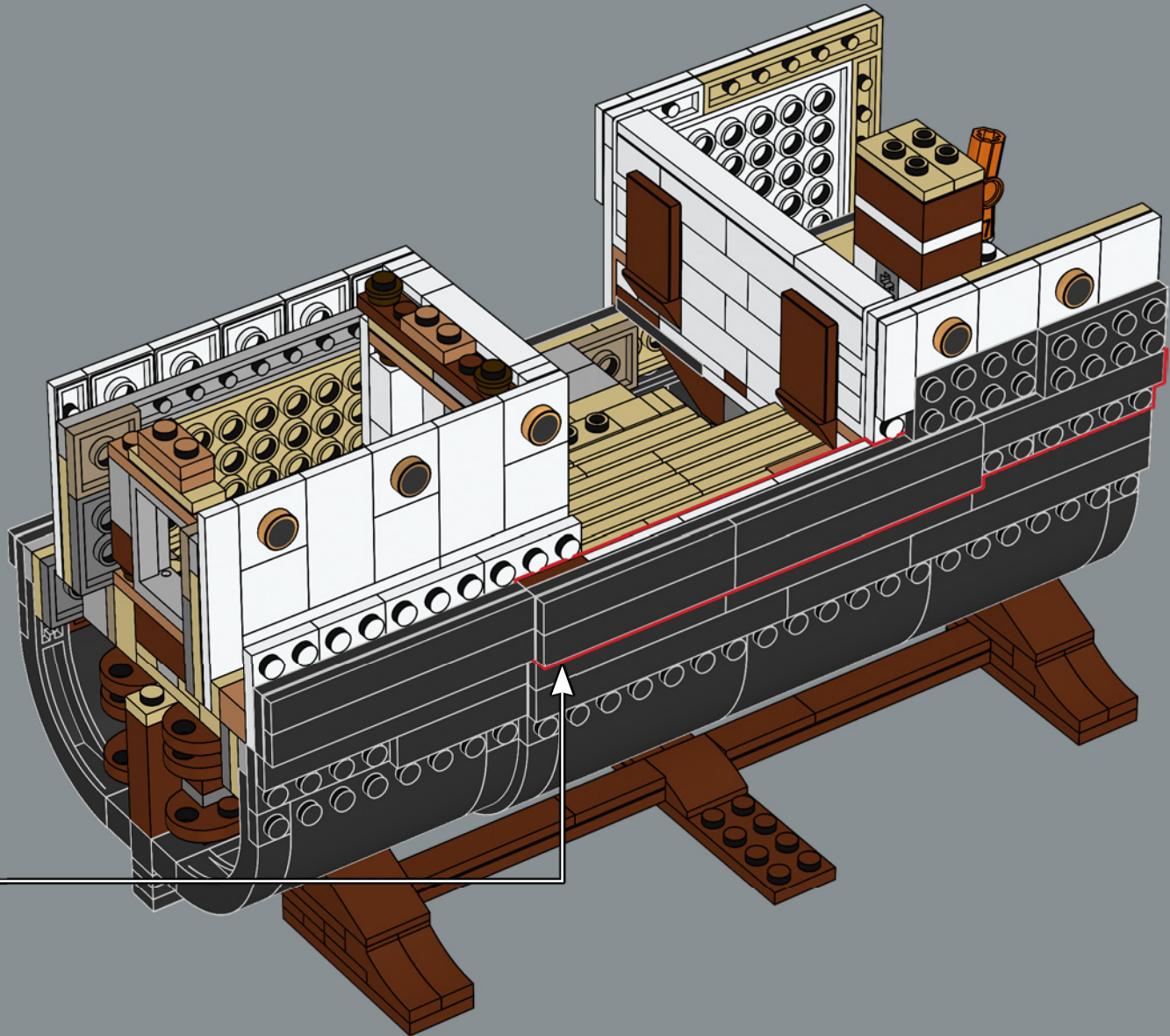

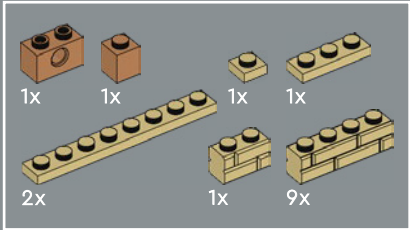
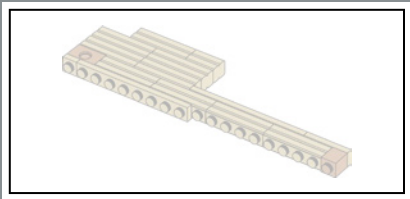

255

1

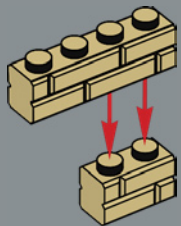

2

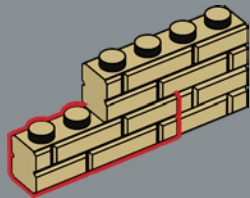

3

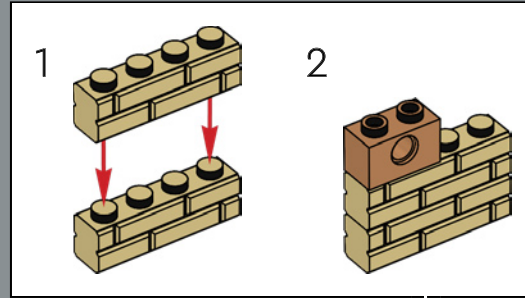
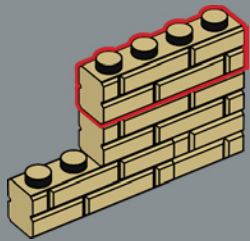

4

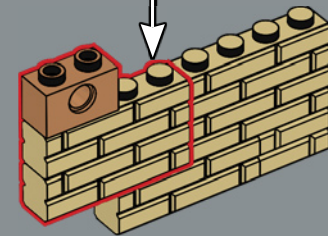

5

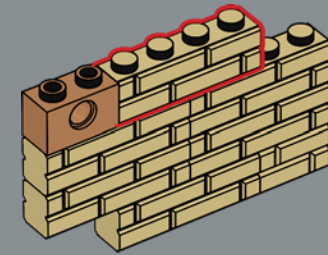

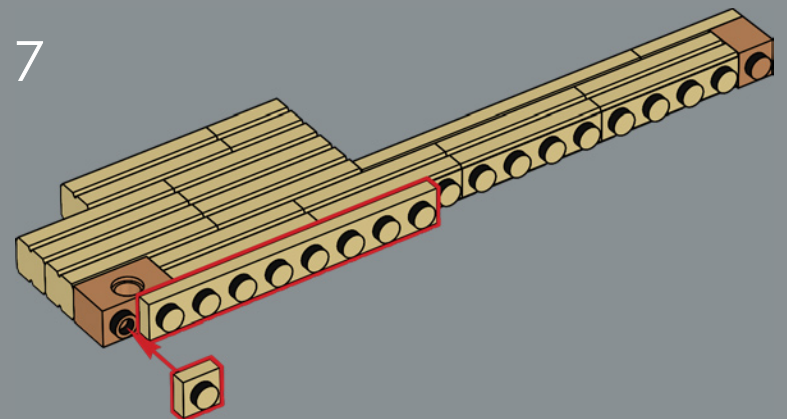
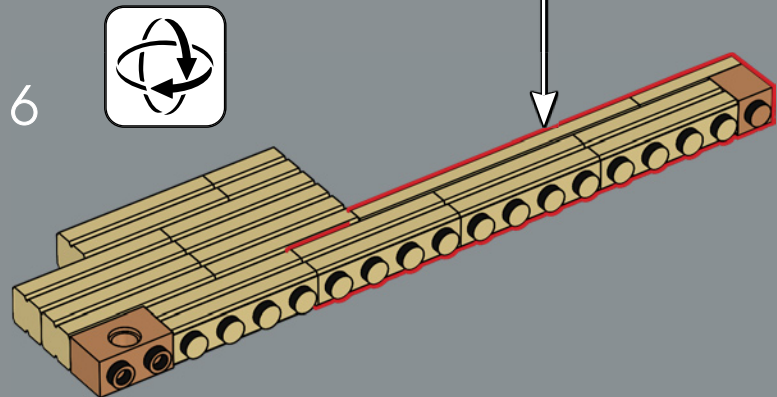
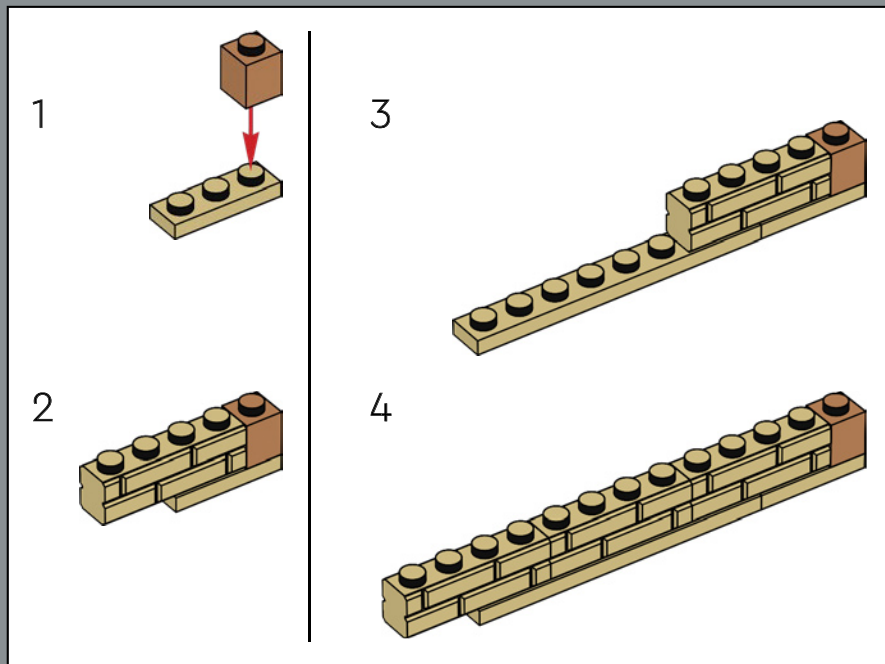

Per conferire al ponte inferiore l'aspetto di assi di legno, qui viene utilizzato il lato posteriore dei mattoncini con profilo "muro" LEGO®.

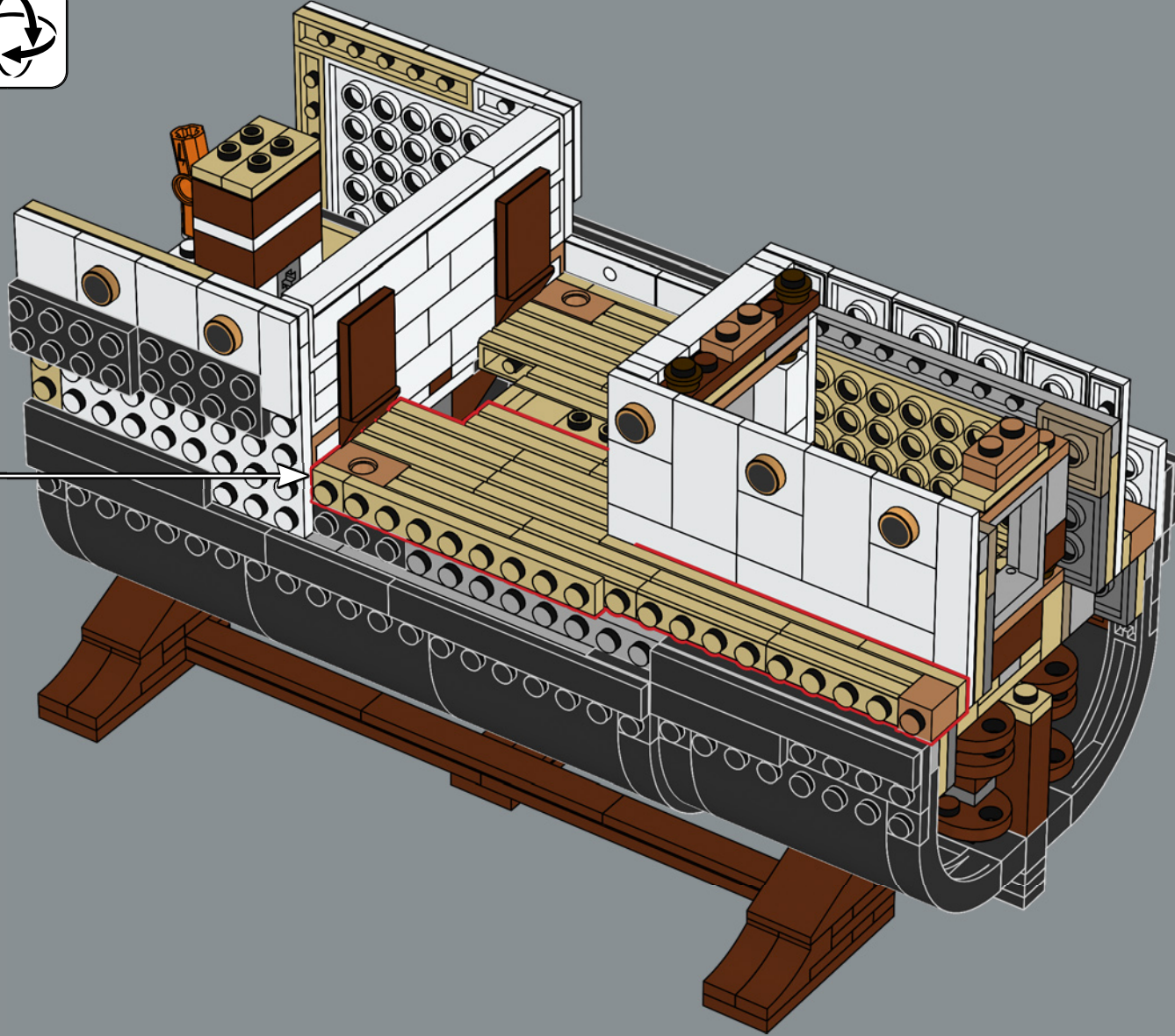

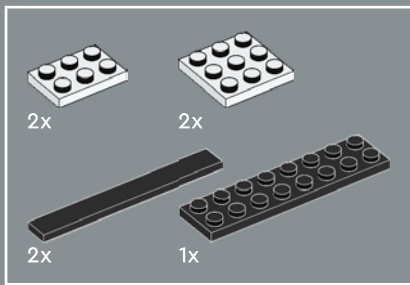

256

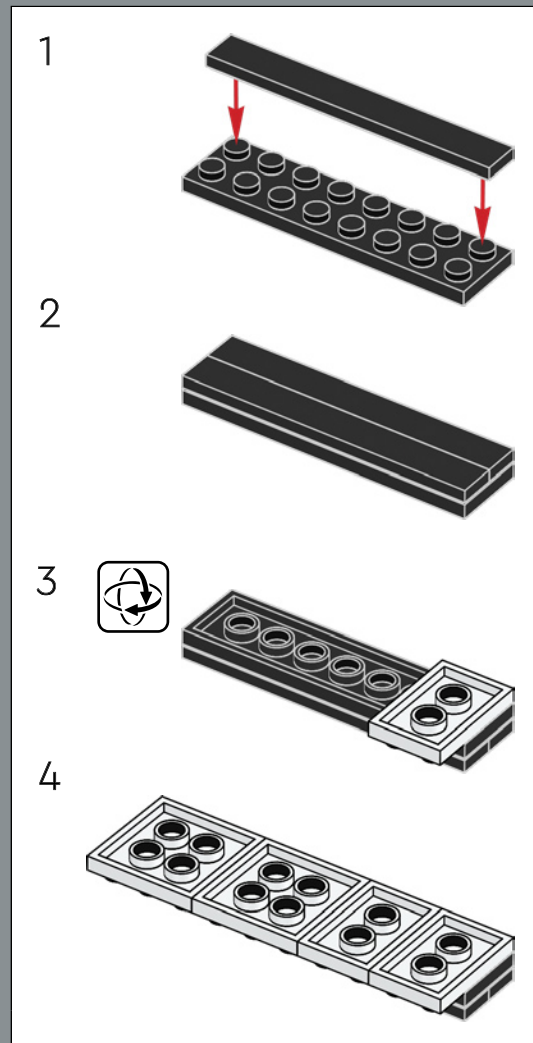
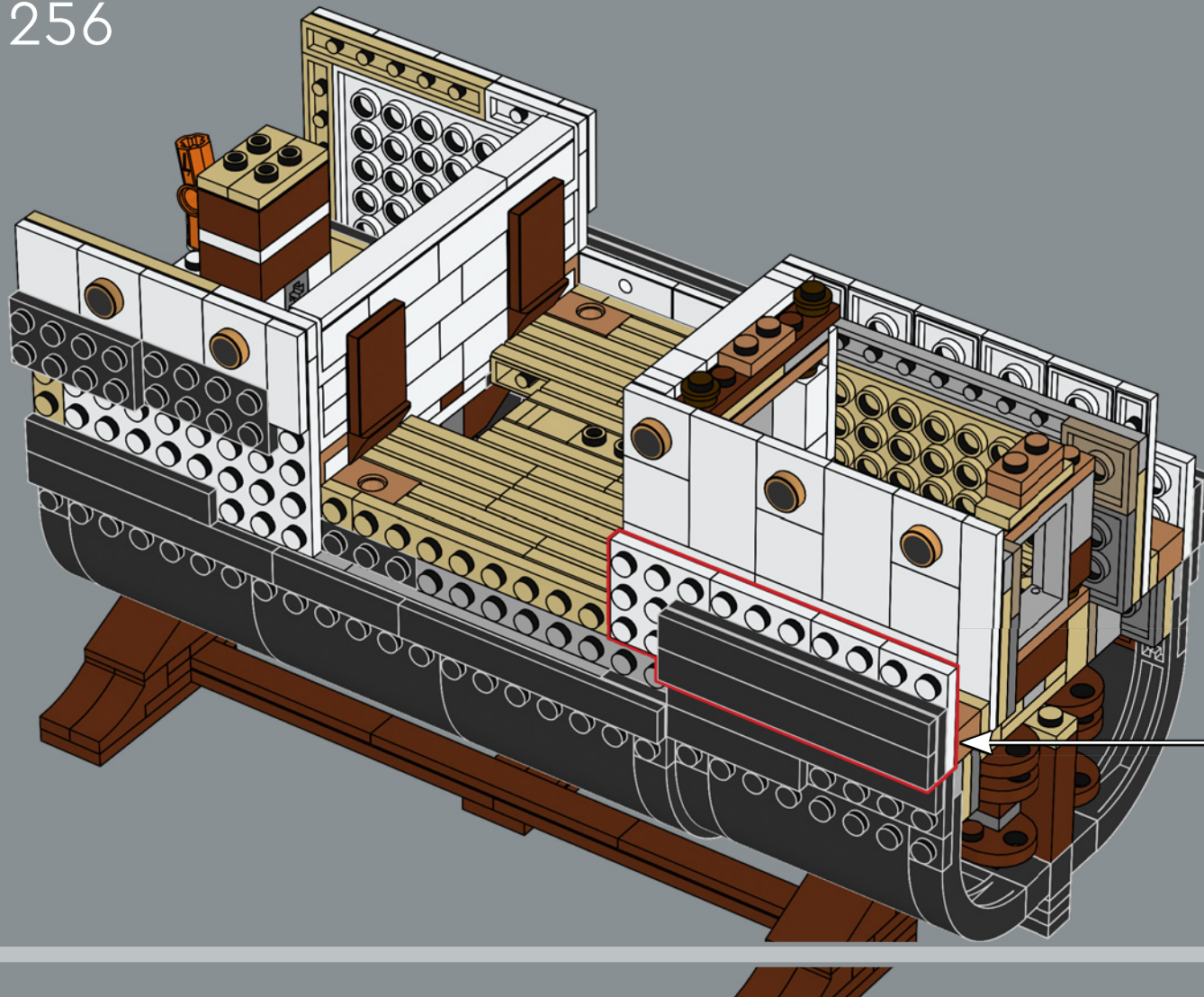

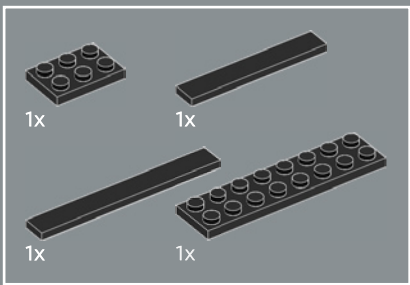

257

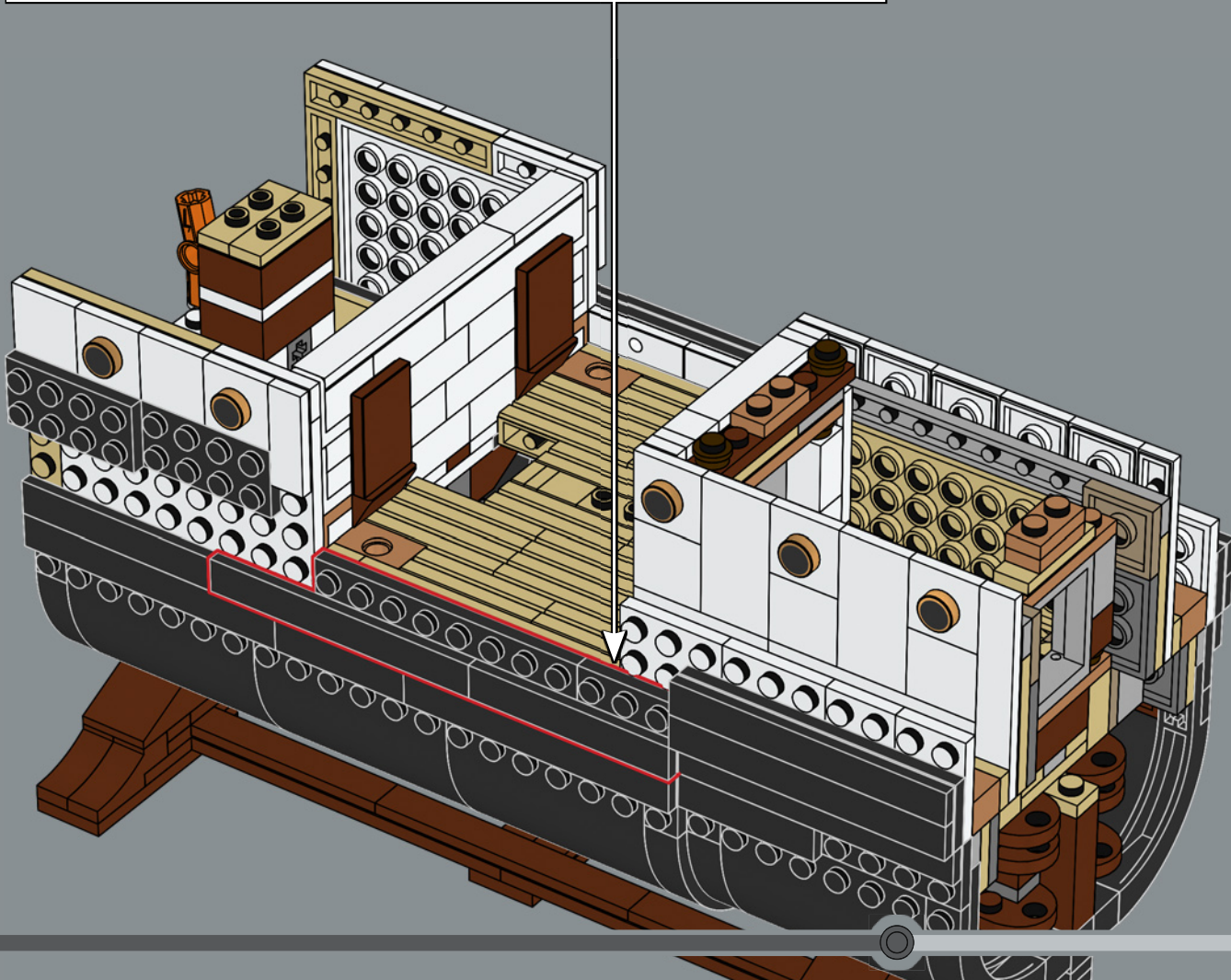
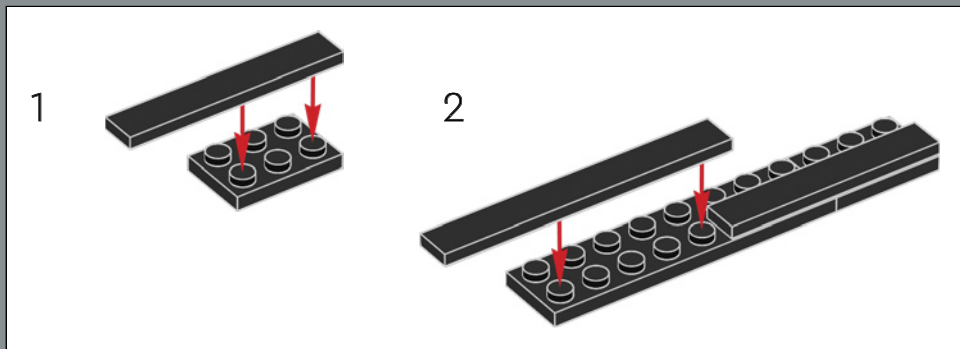

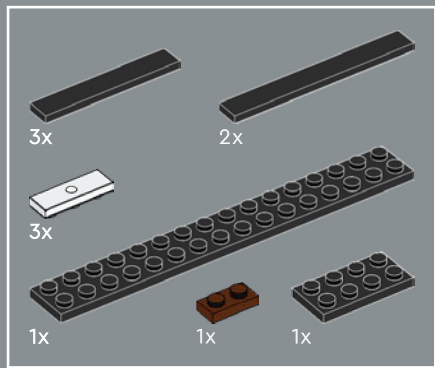

258

1

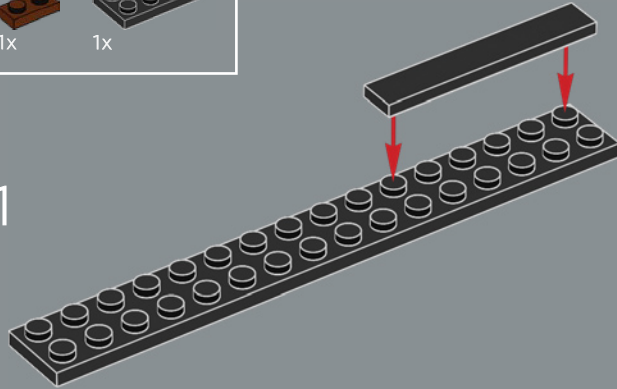

2

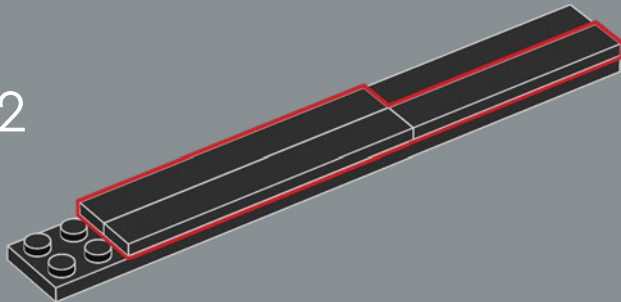

3

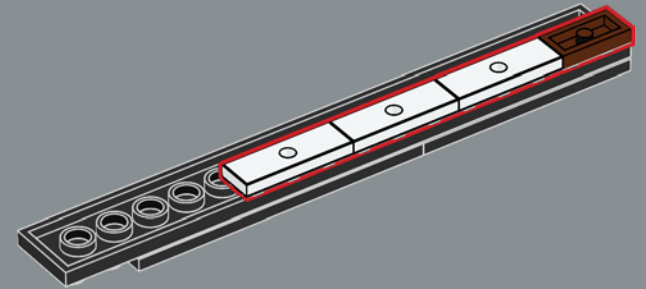

4

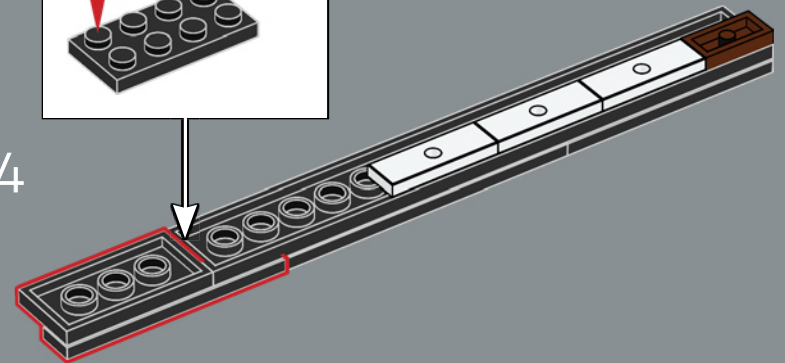
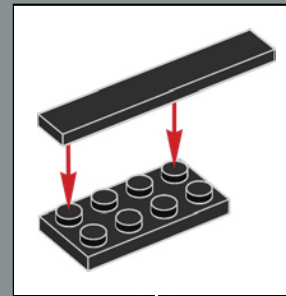

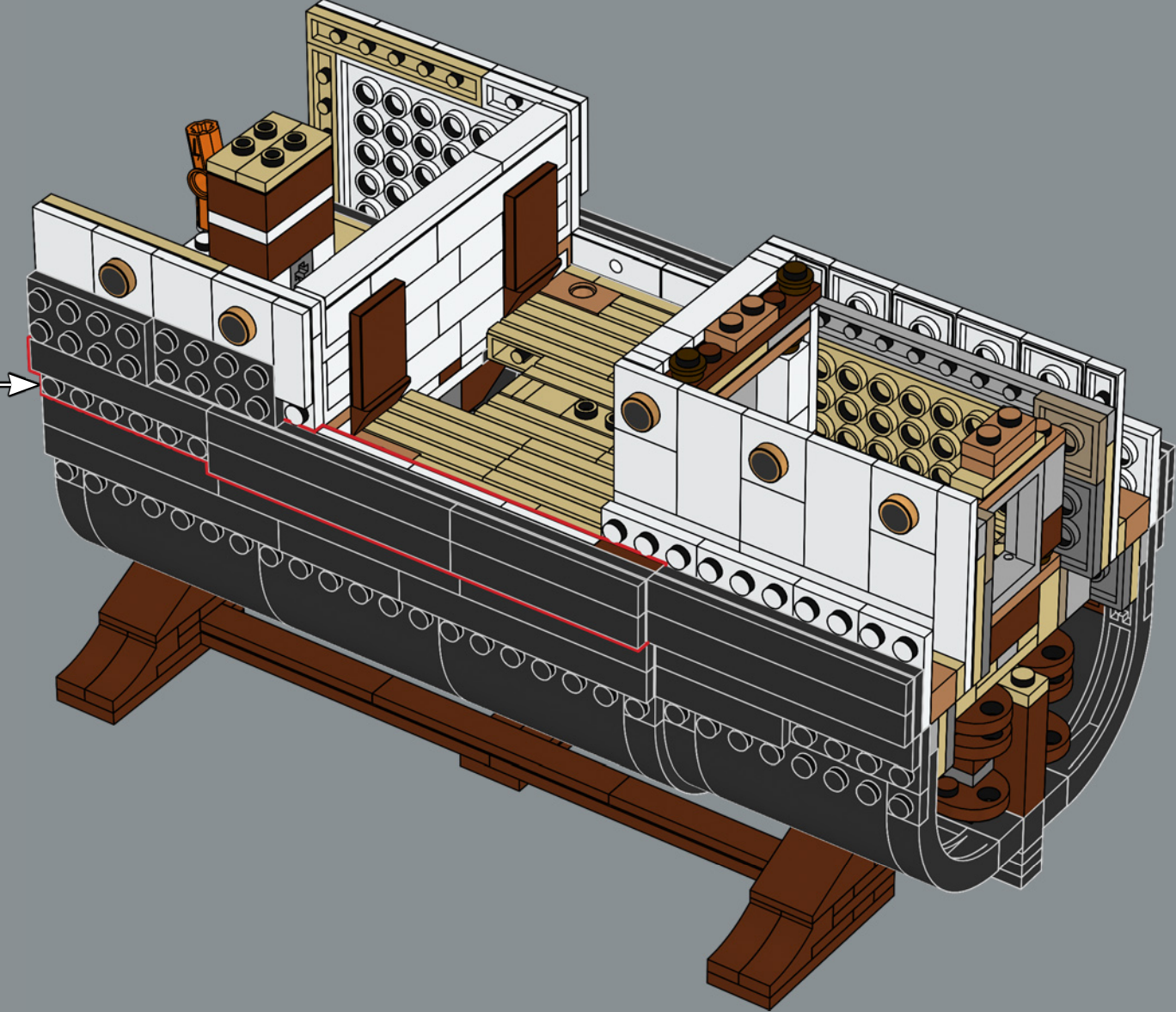

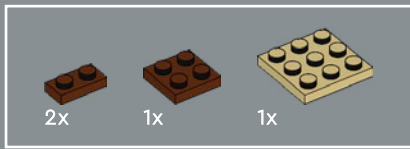

259

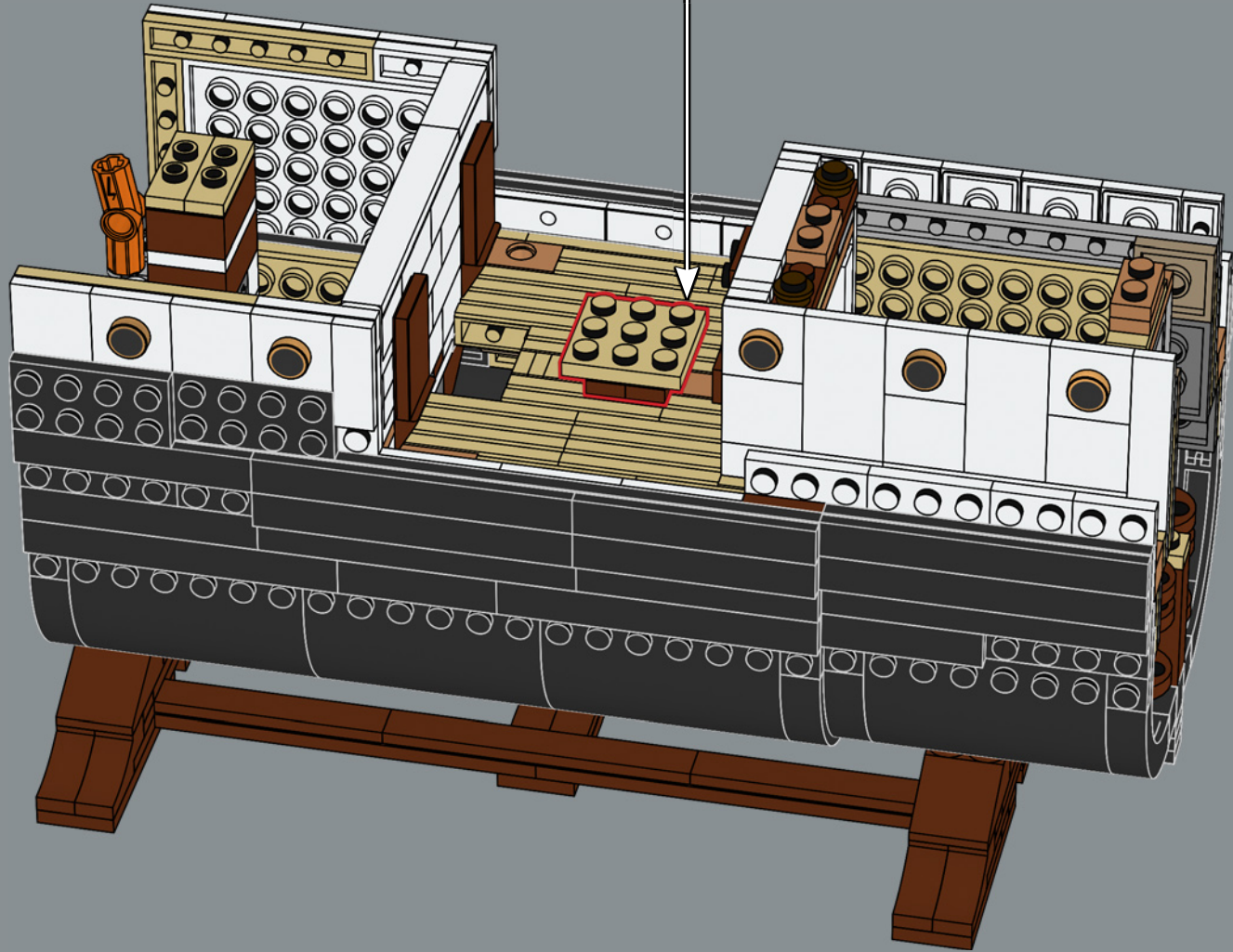
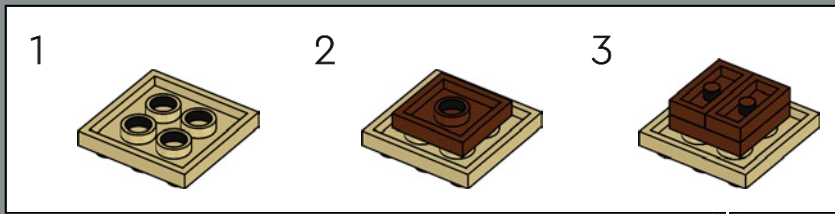

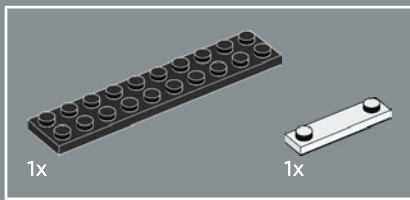
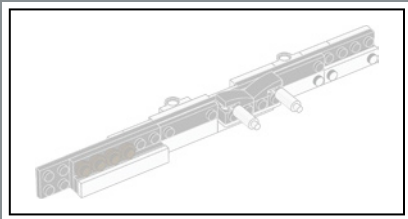

260

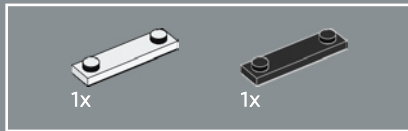
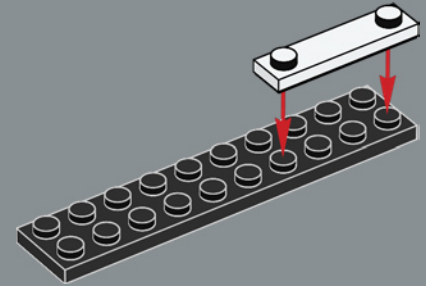

261

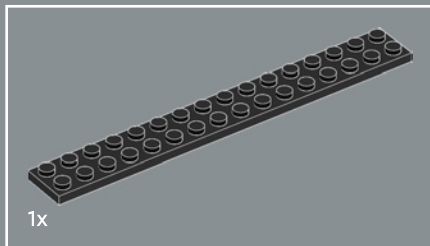
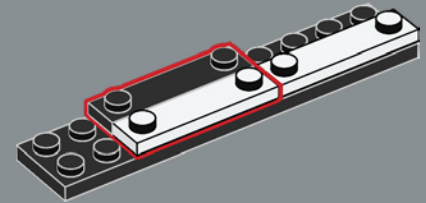

262

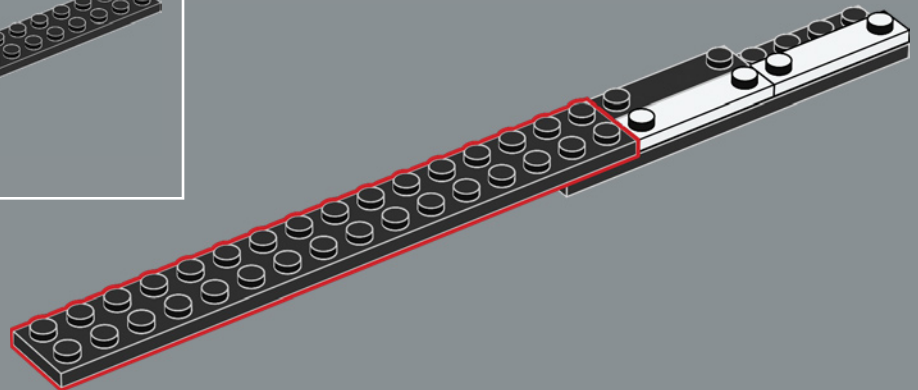

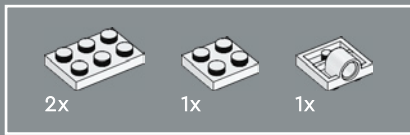

263

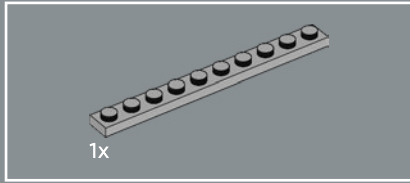
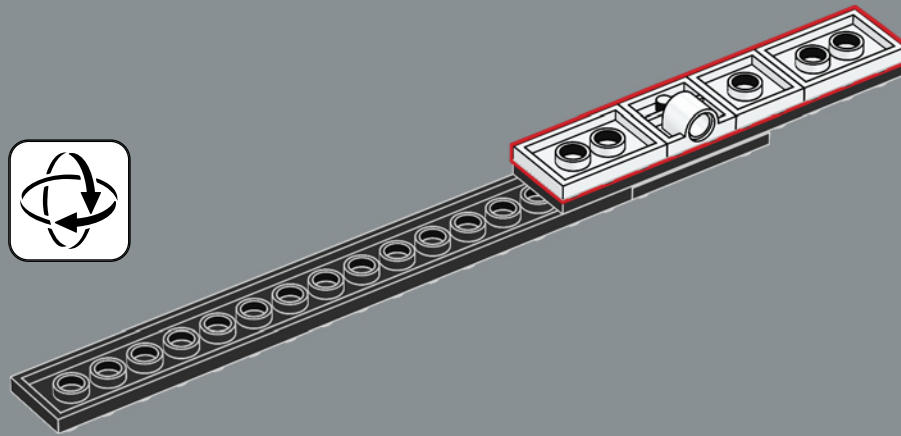

264

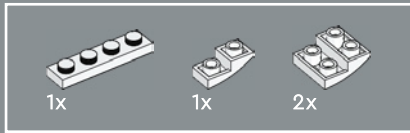
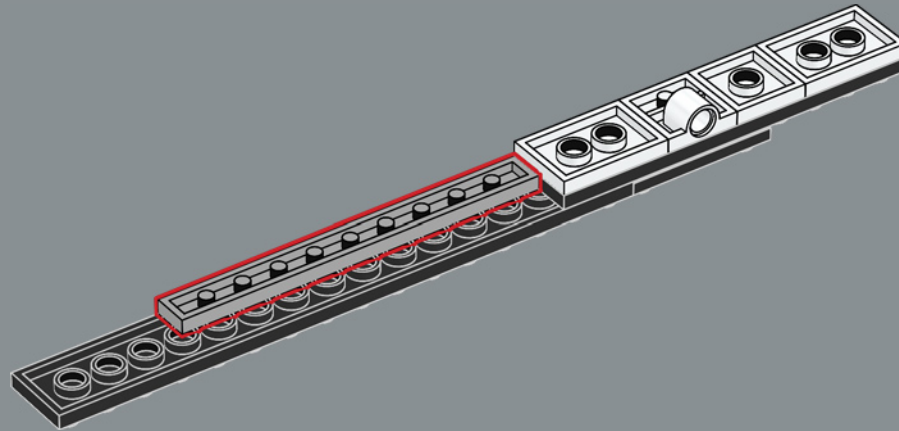

265

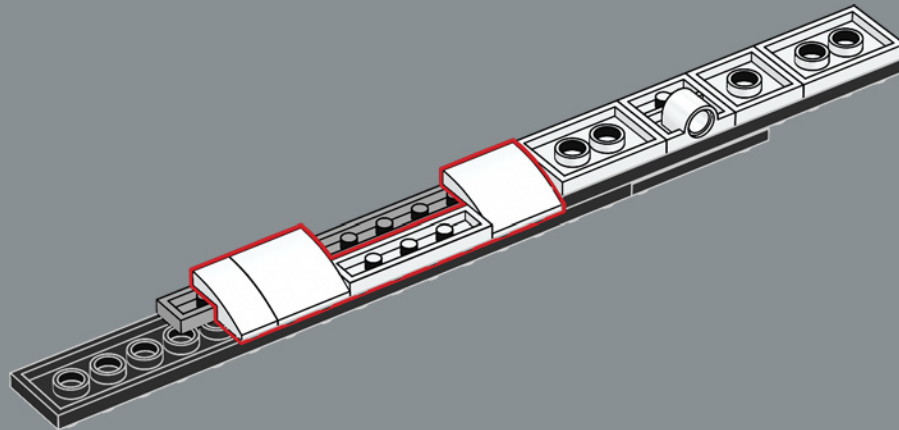



266

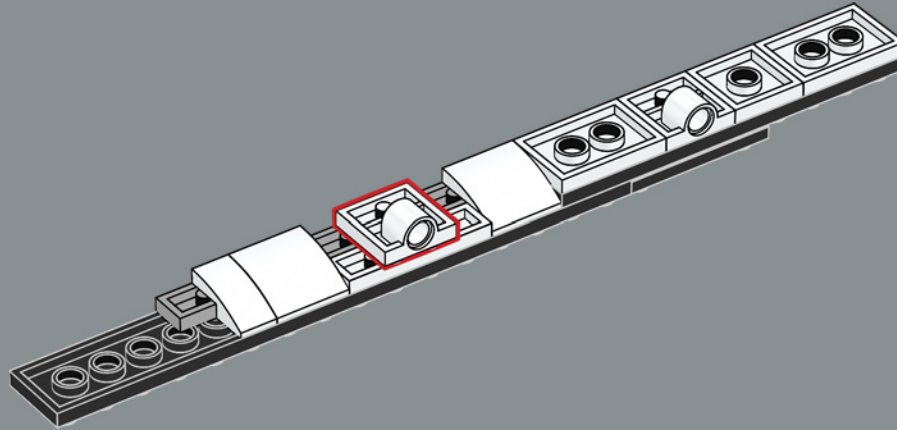

267

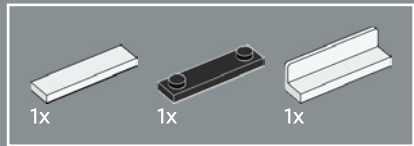
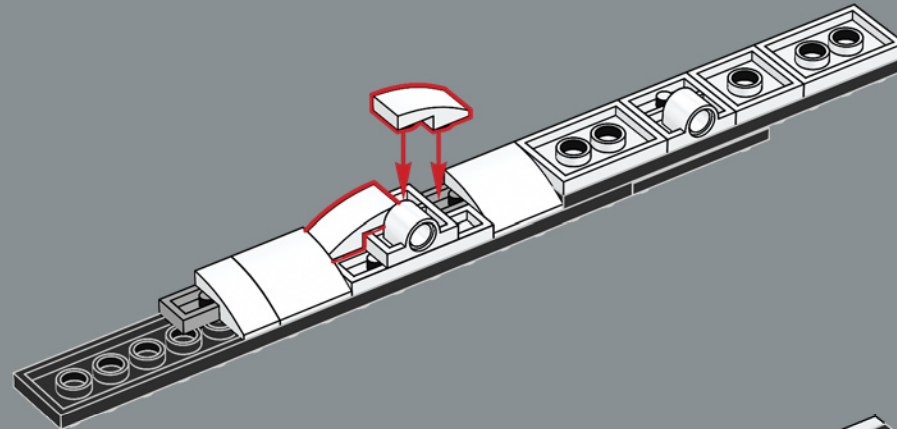

268

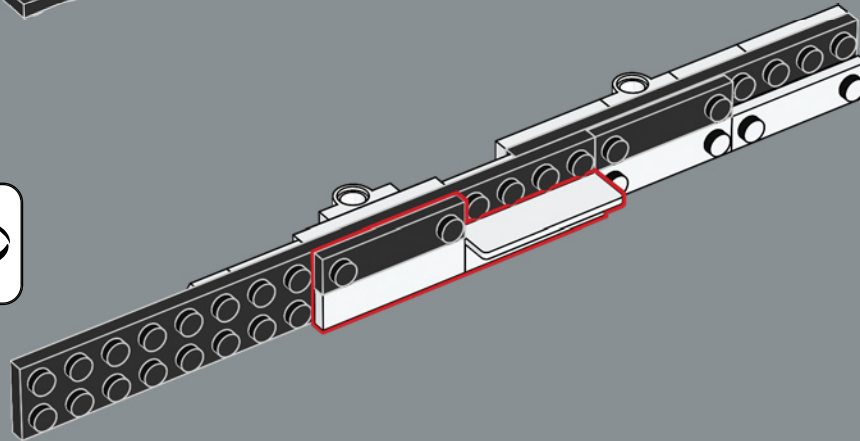

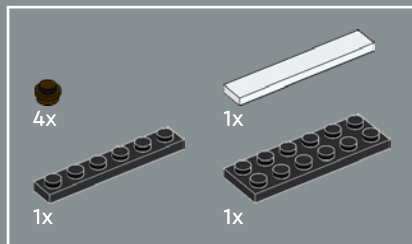

269

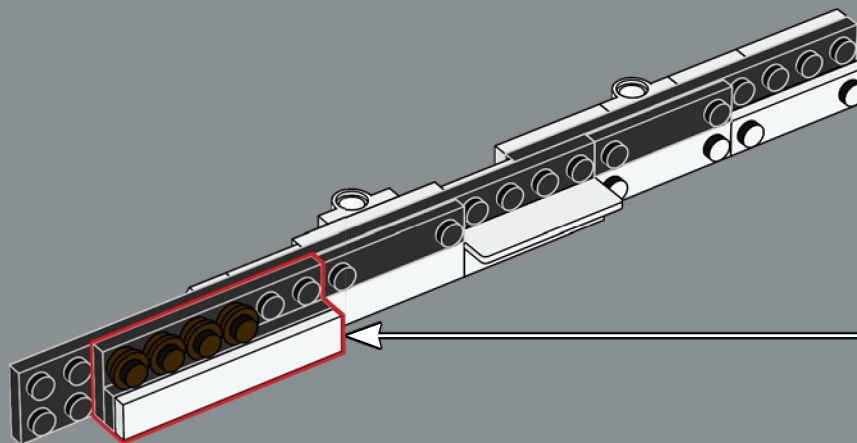
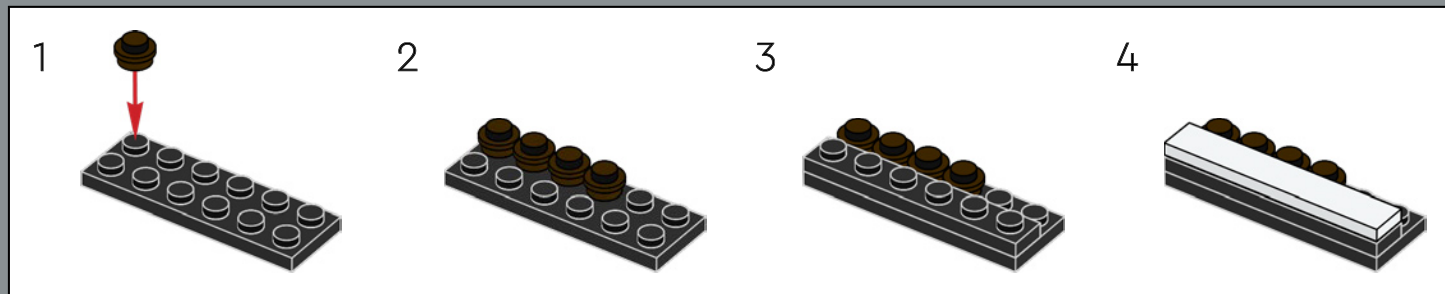



4x

270

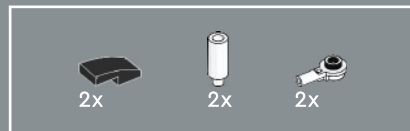
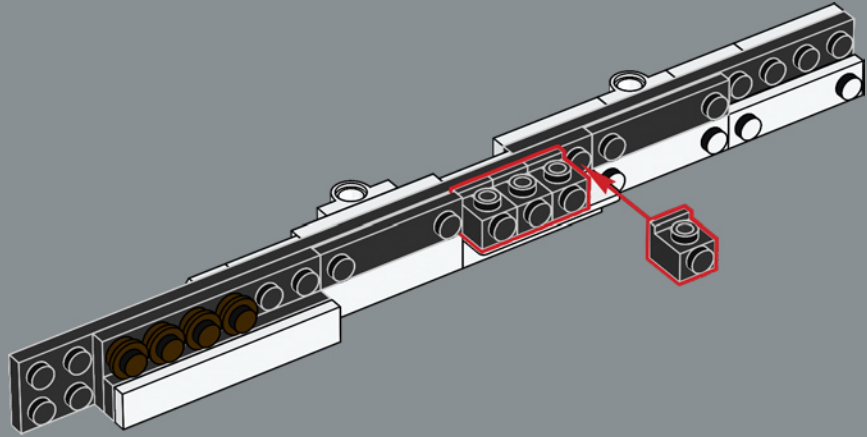

271

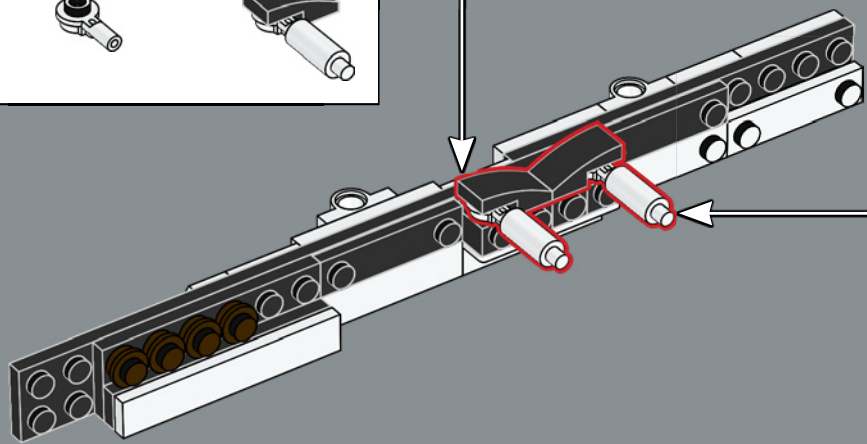
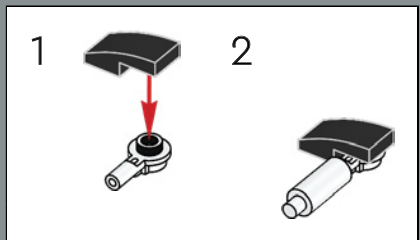
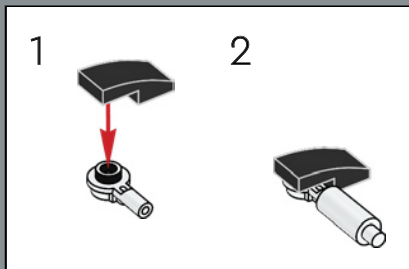

272

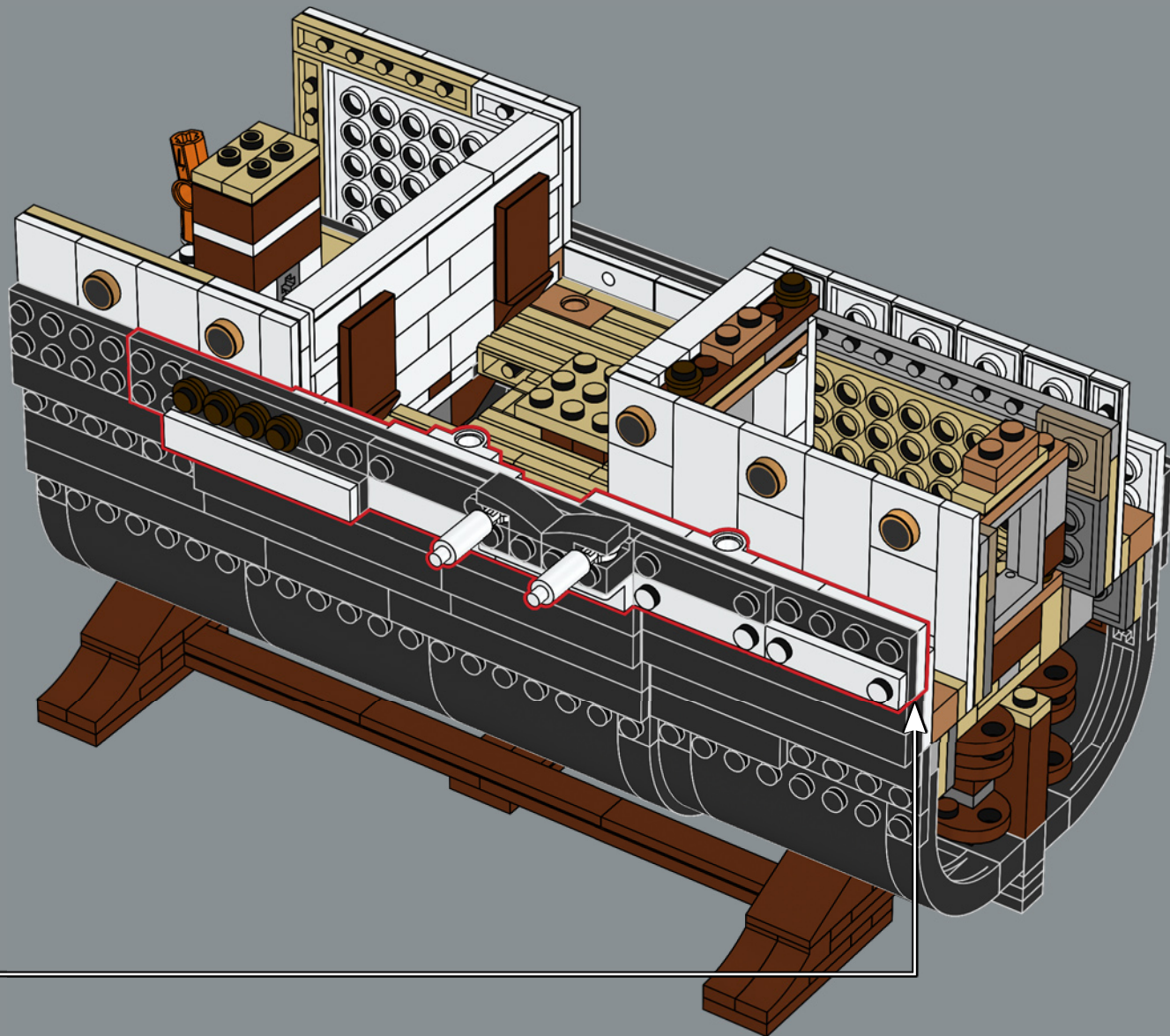

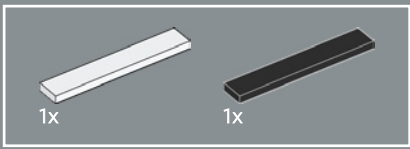

273

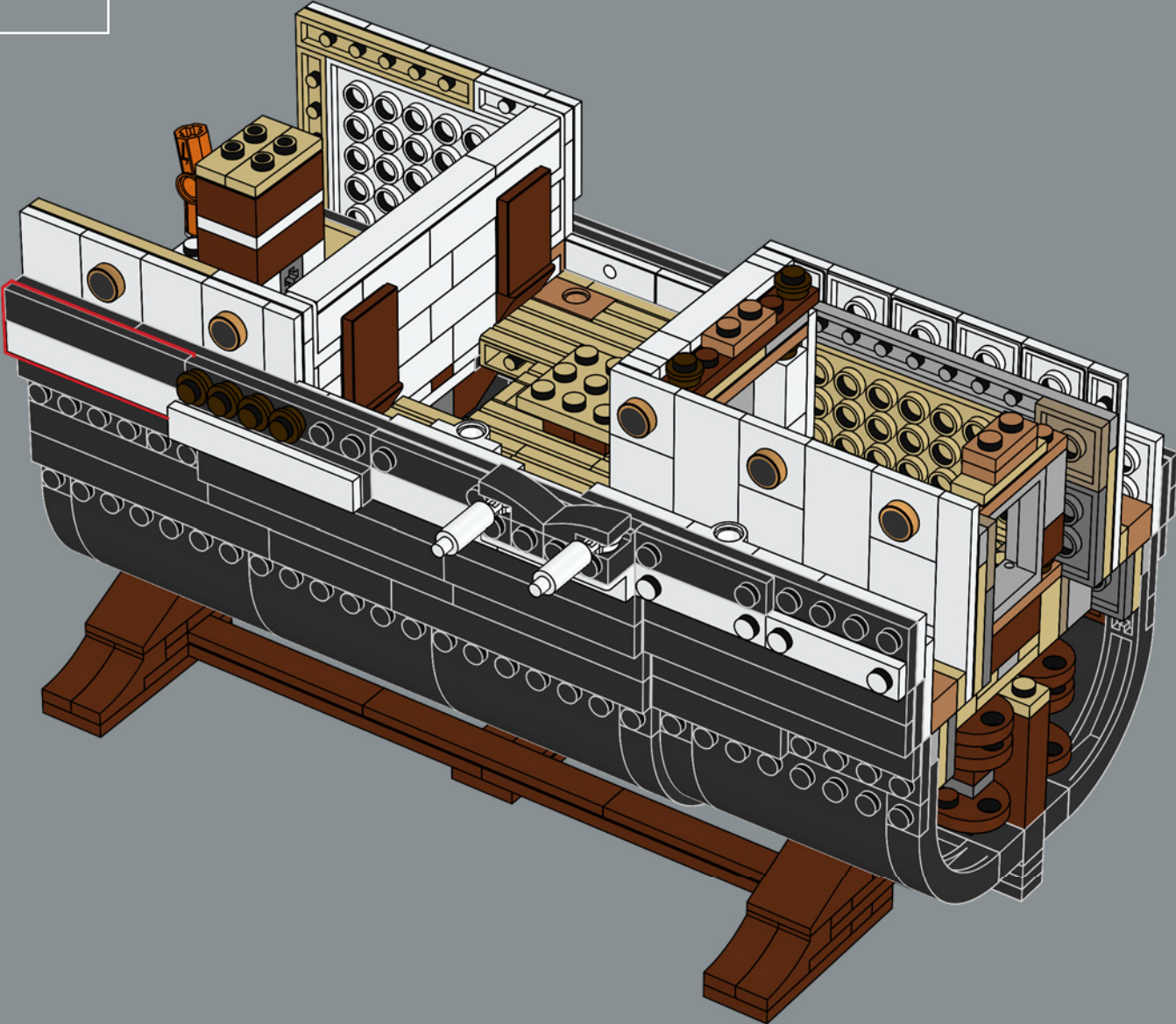

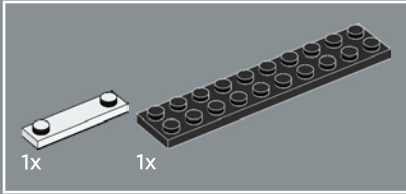
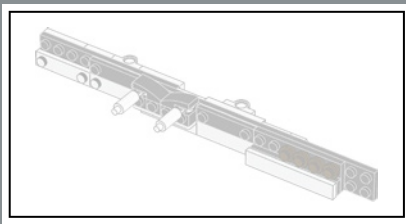

274

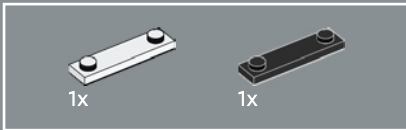
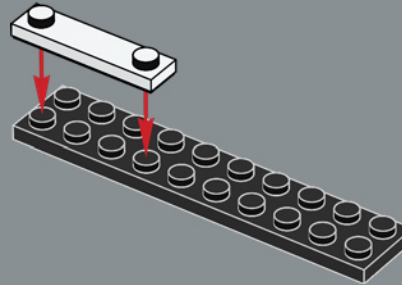

275

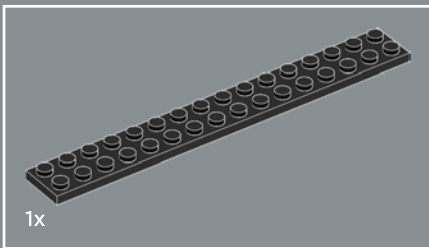
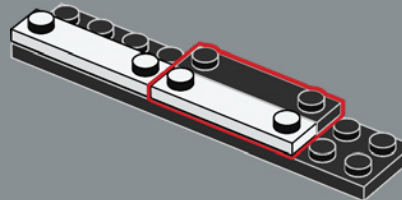

276

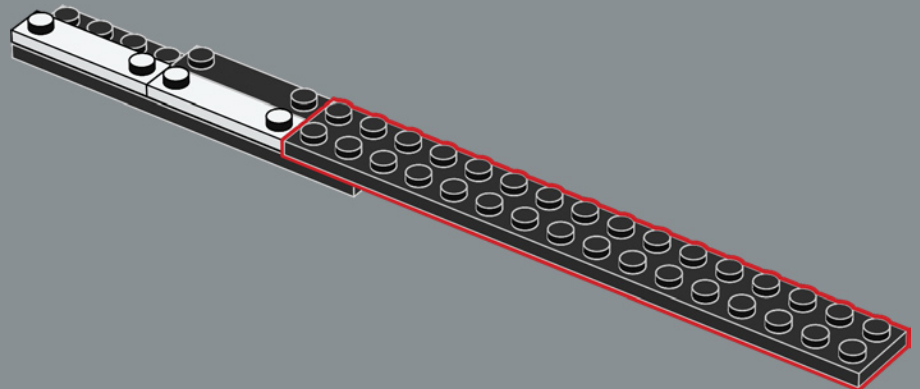

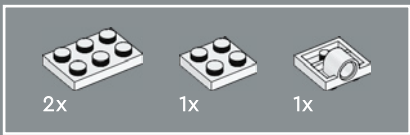

277

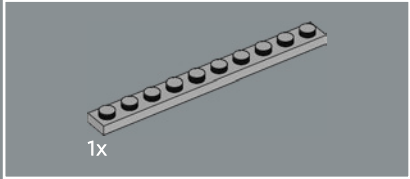
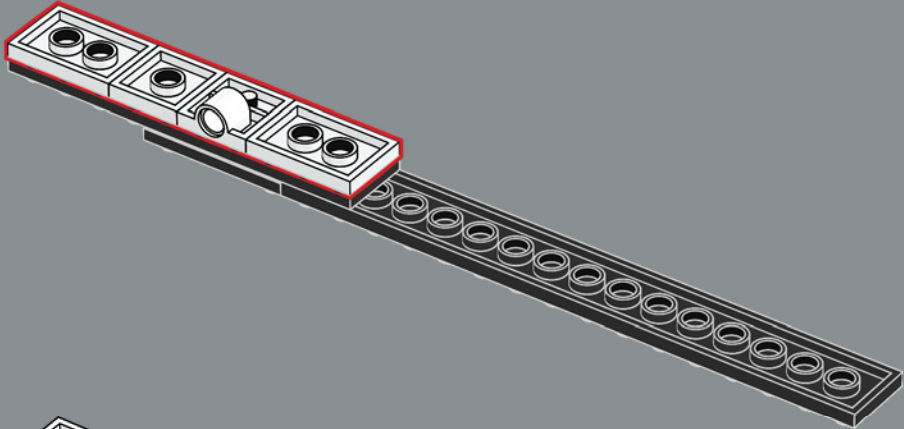

278

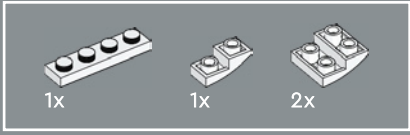
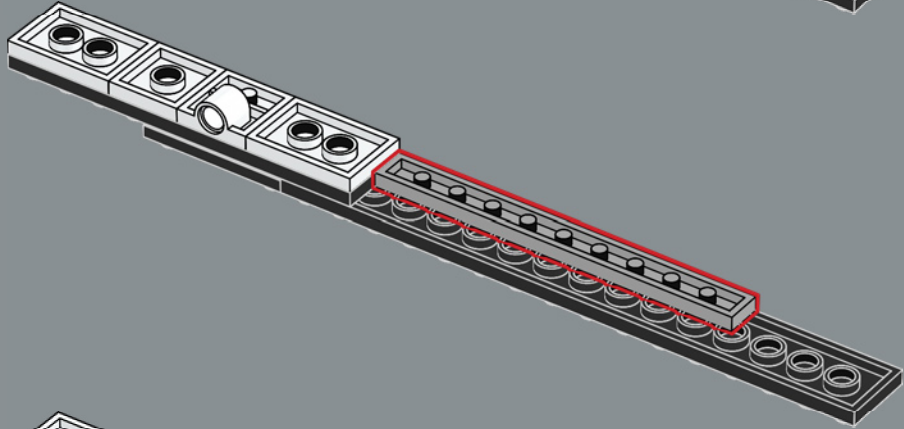

279

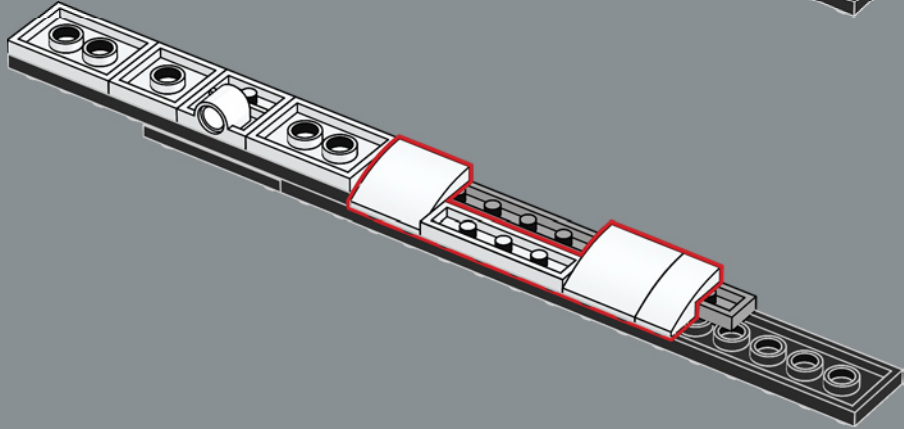

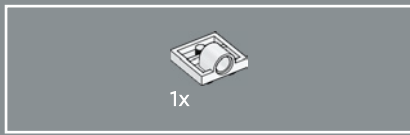

280



281

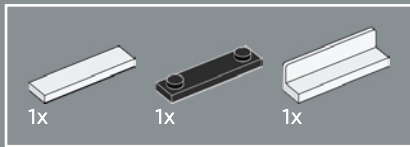

282

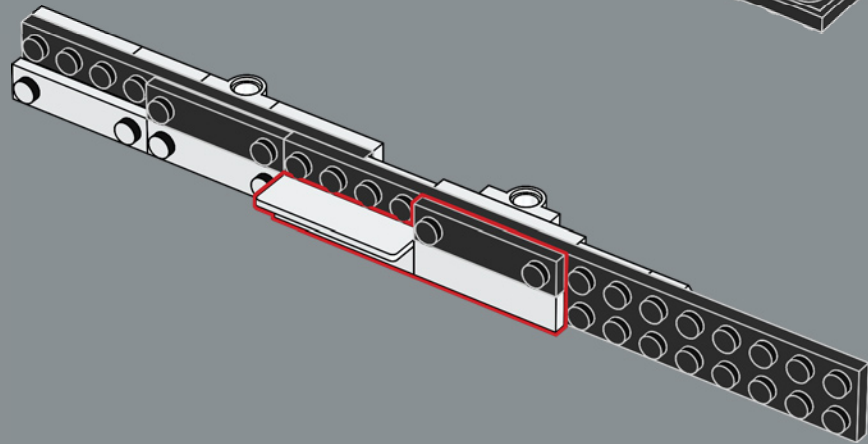
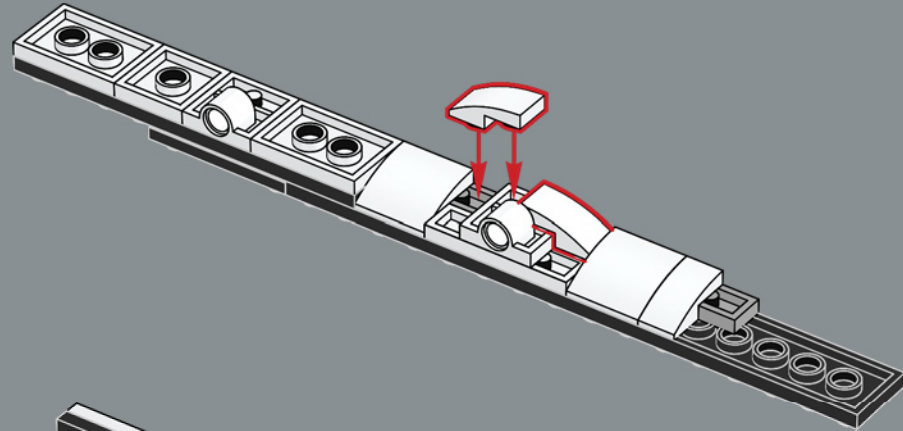
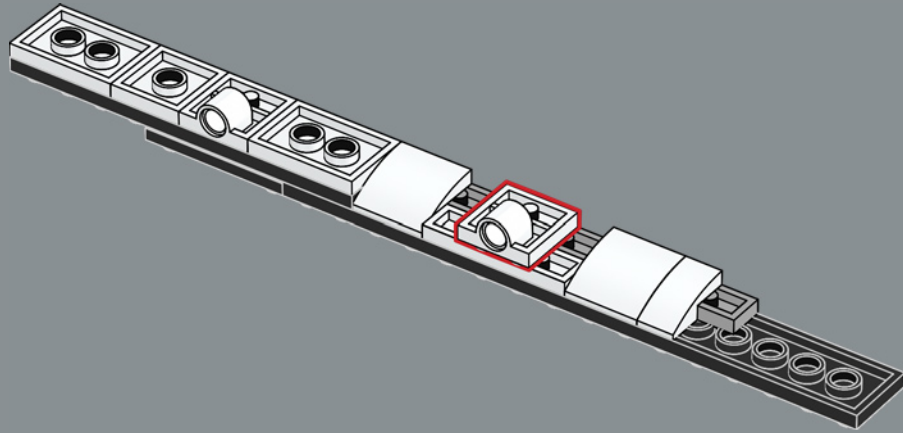

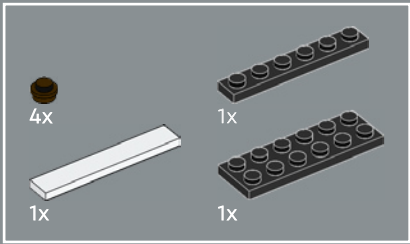

283

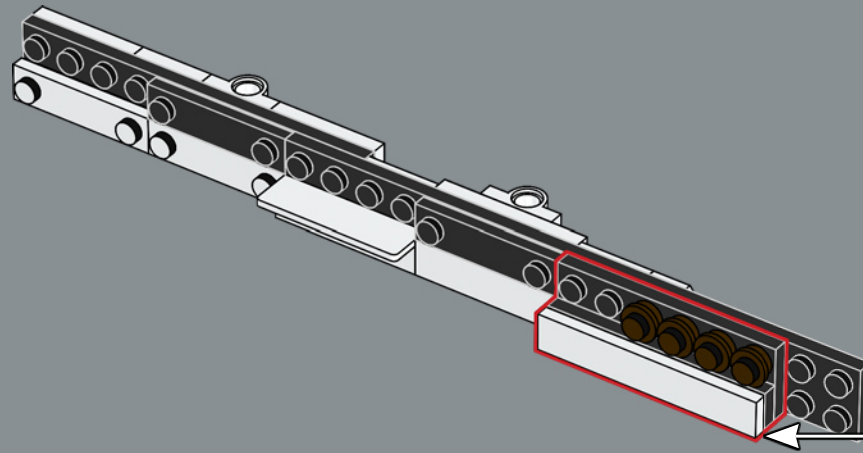
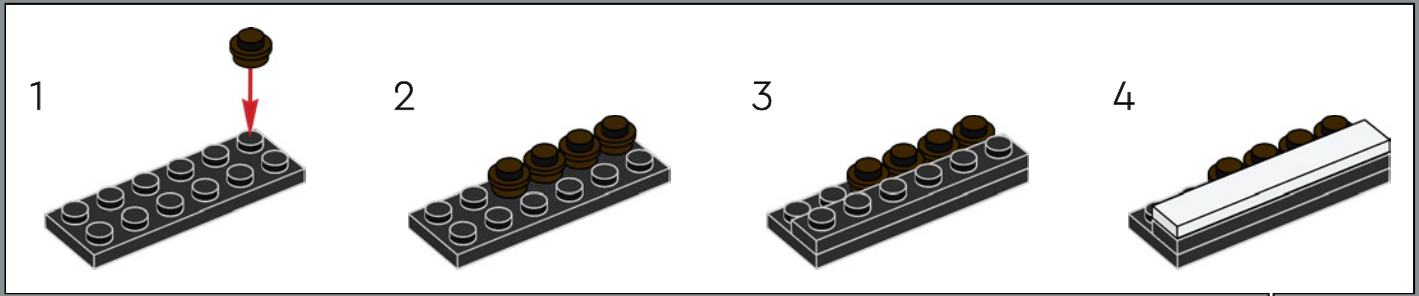



284

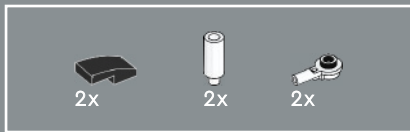
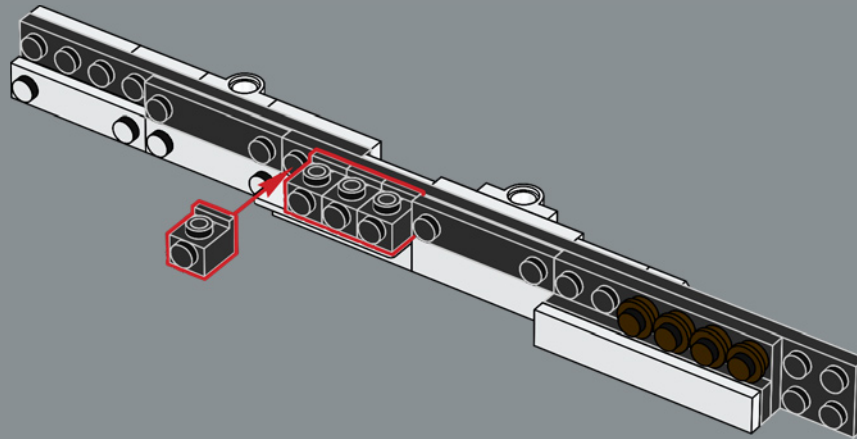

285

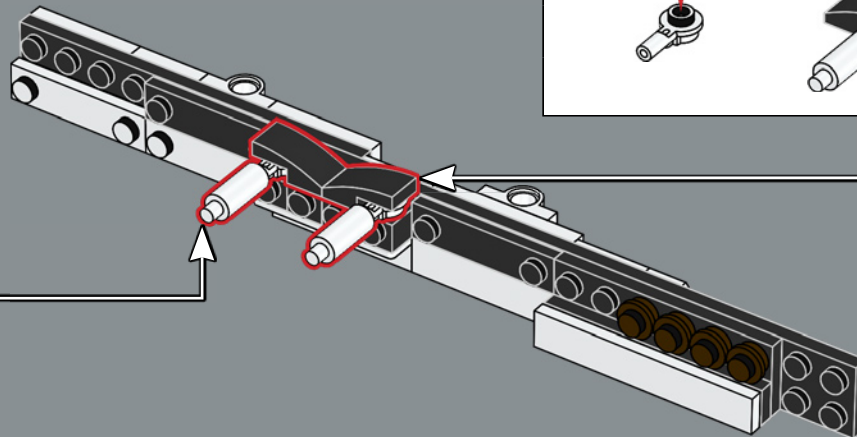
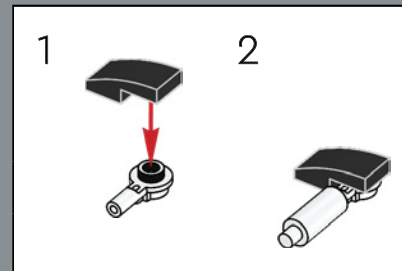
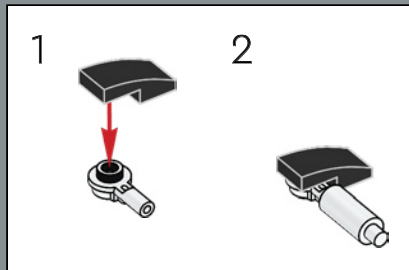

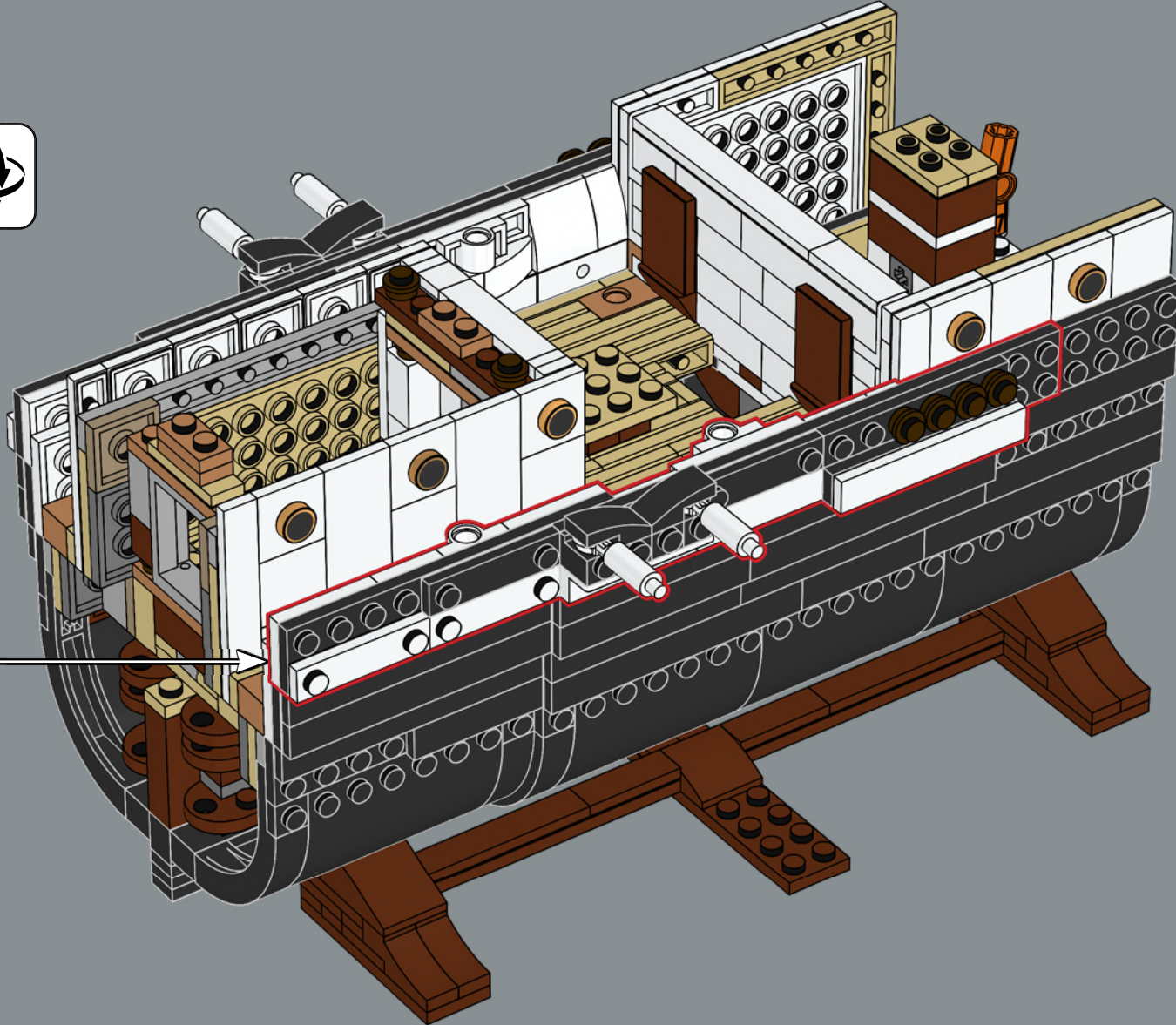

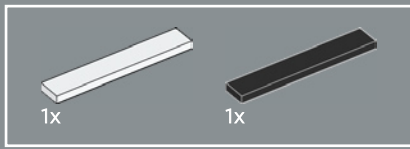

287

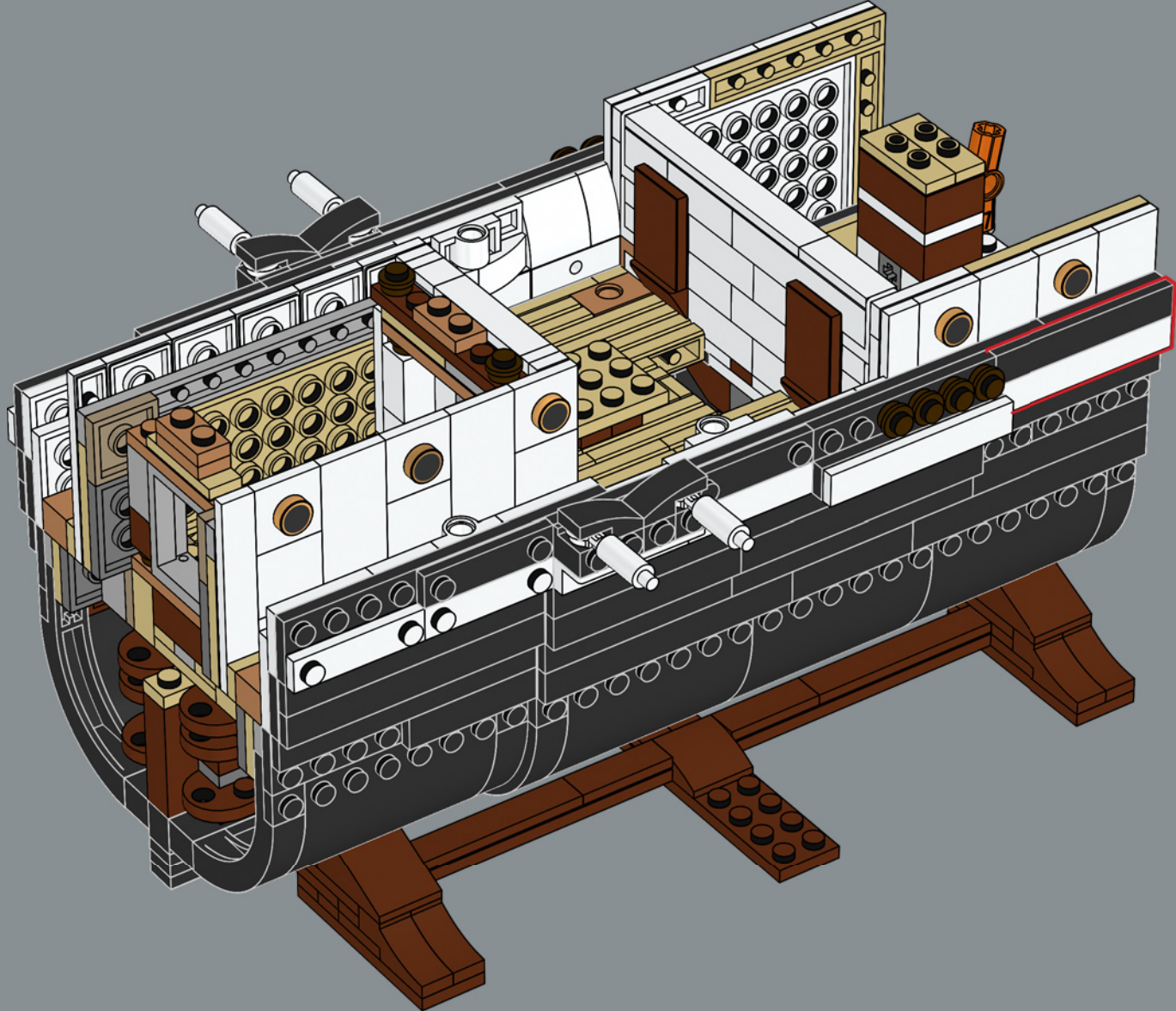

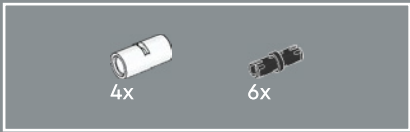

288

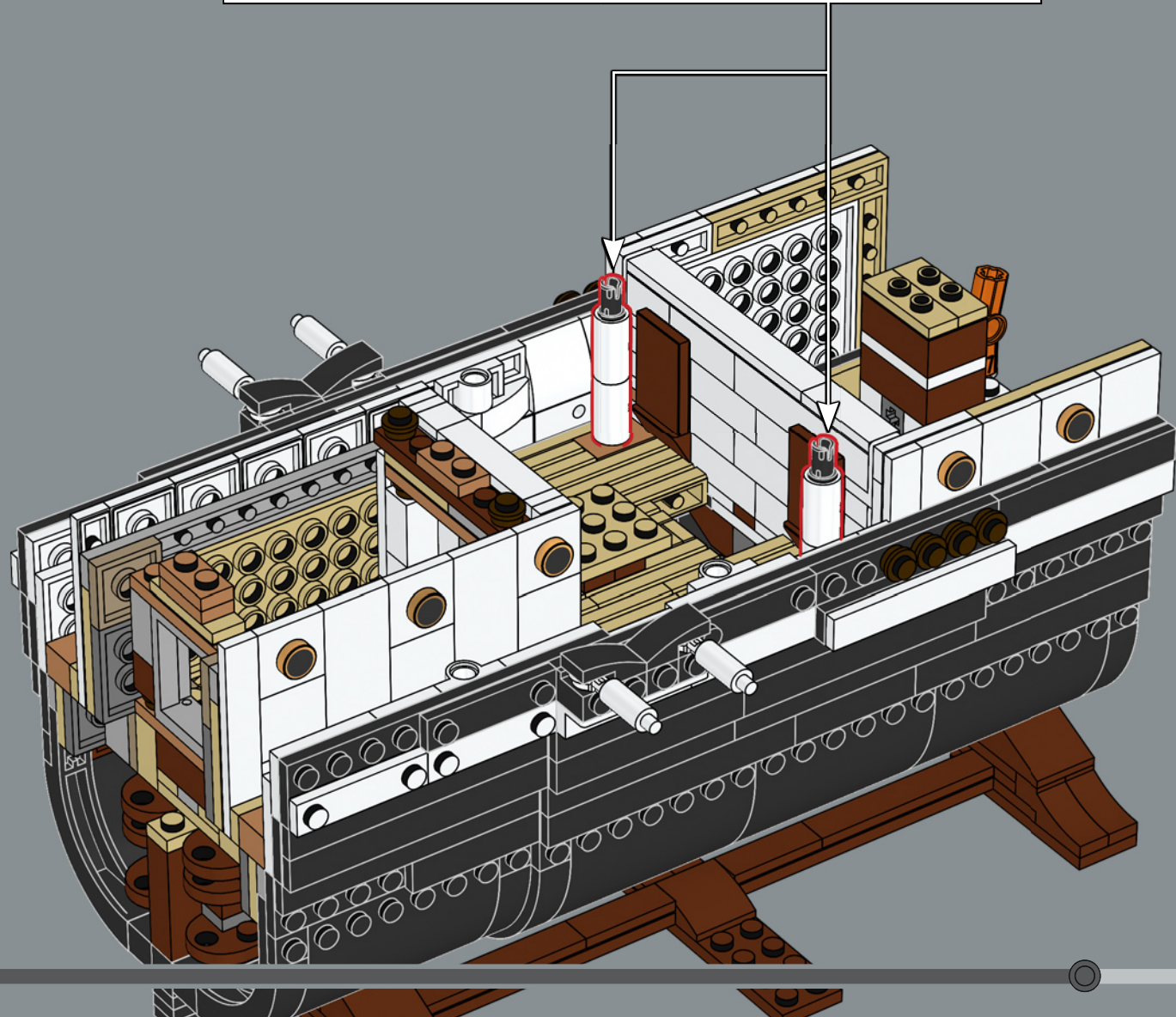
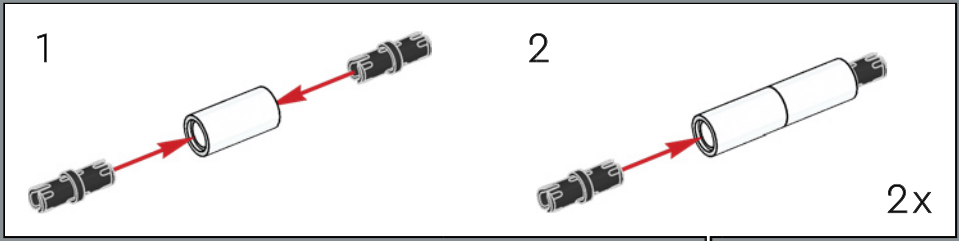

289

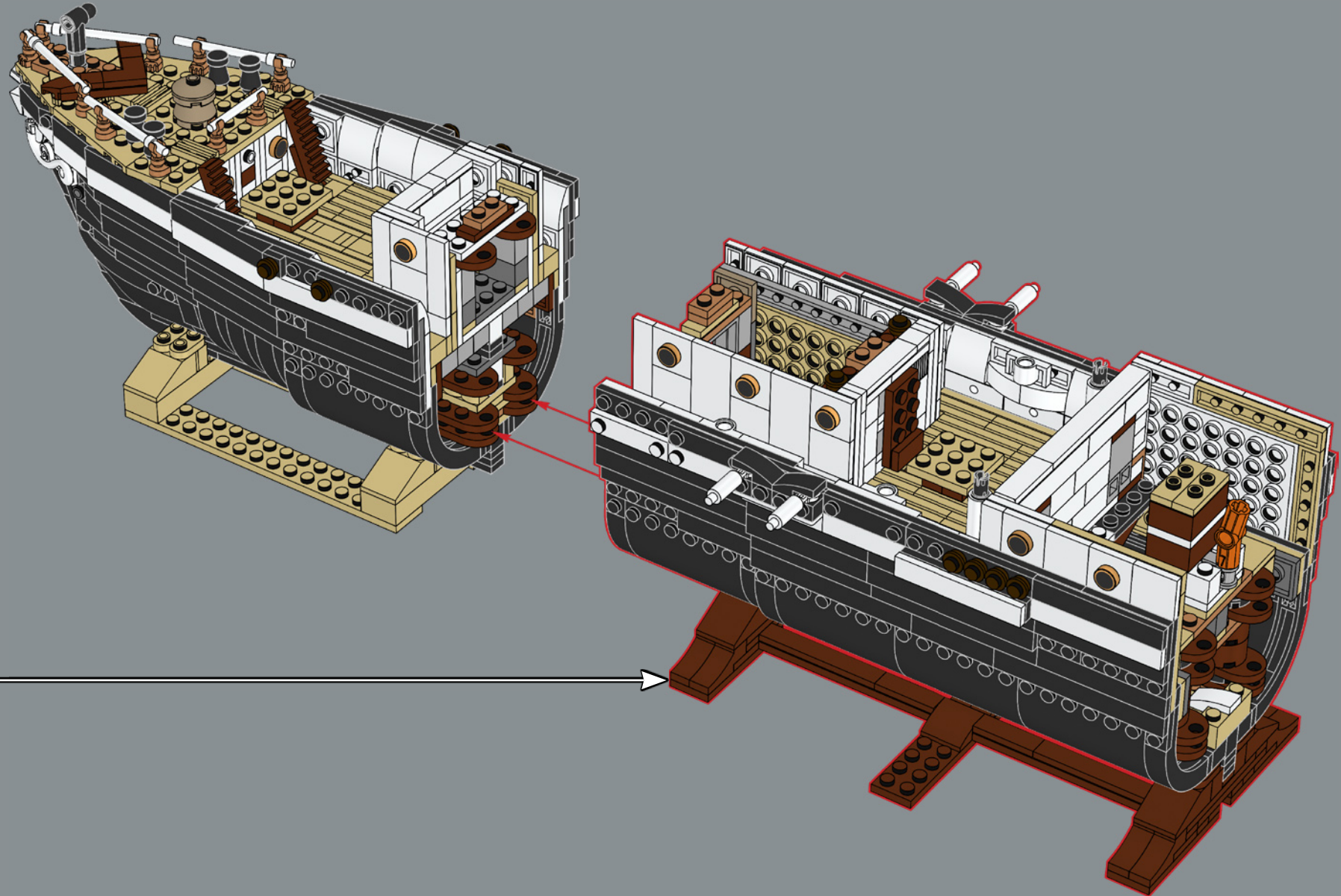



I maestri artigiani resero l'*Endurance* una delle navi in legno più resistenti mai costruite, rafforzando la robustezza dello scafo, ove possibile. Nel modello LEGO®, le tre sezioni dello scafo sono collegate da assi LEGO Technic, che le mantengono saldamente in posizione.

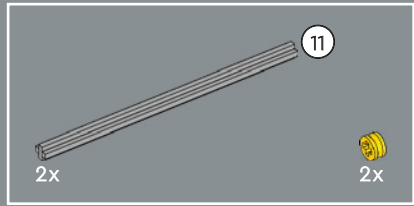

290

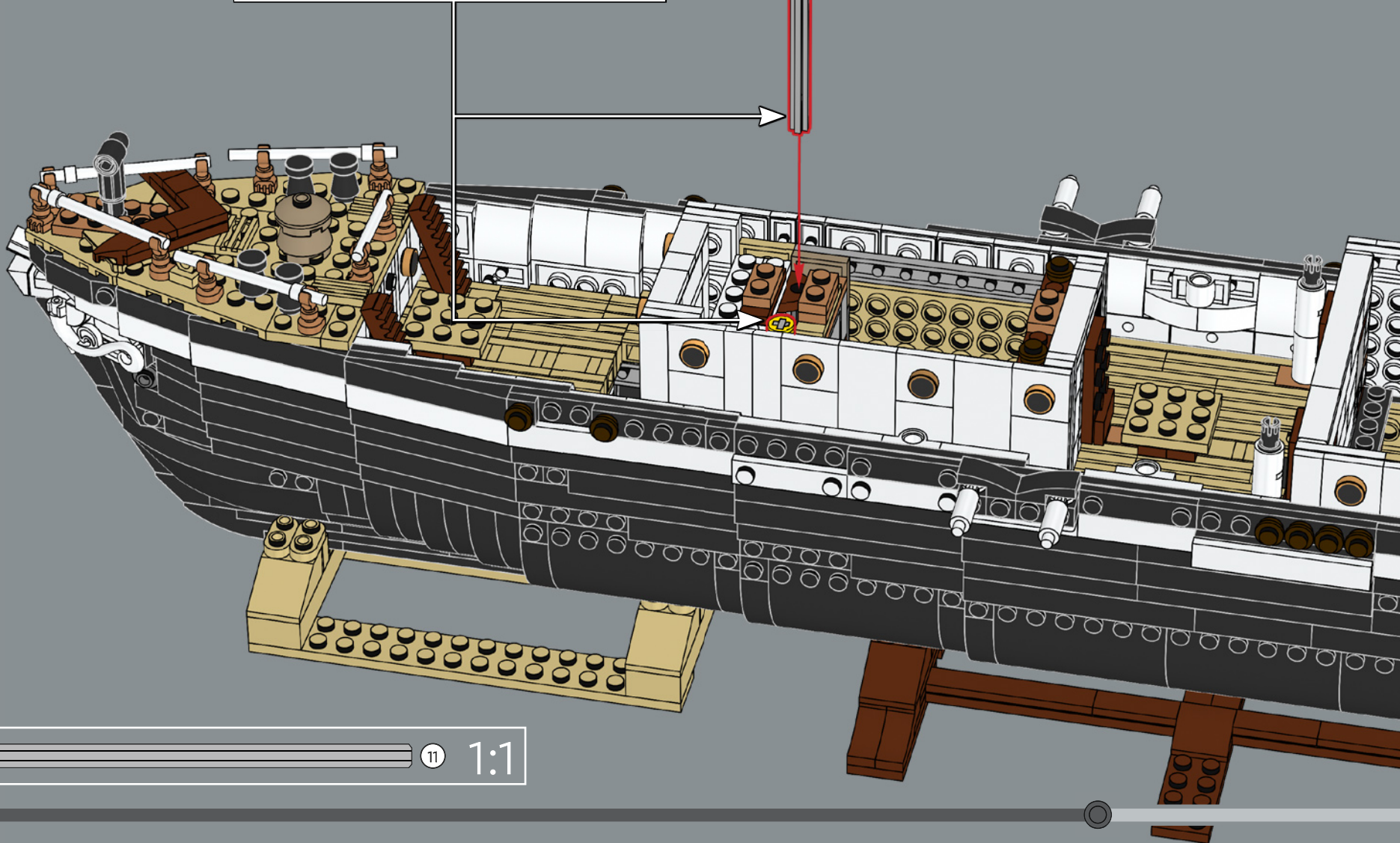
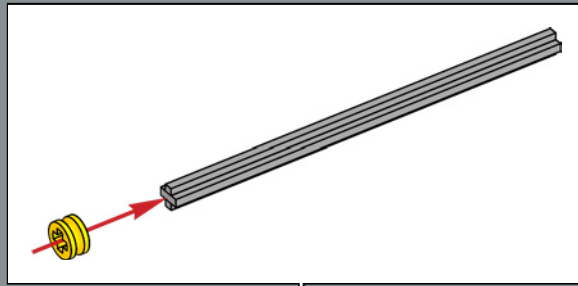

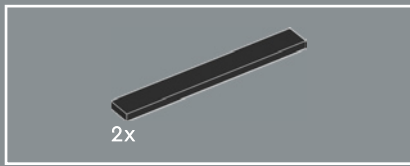

291

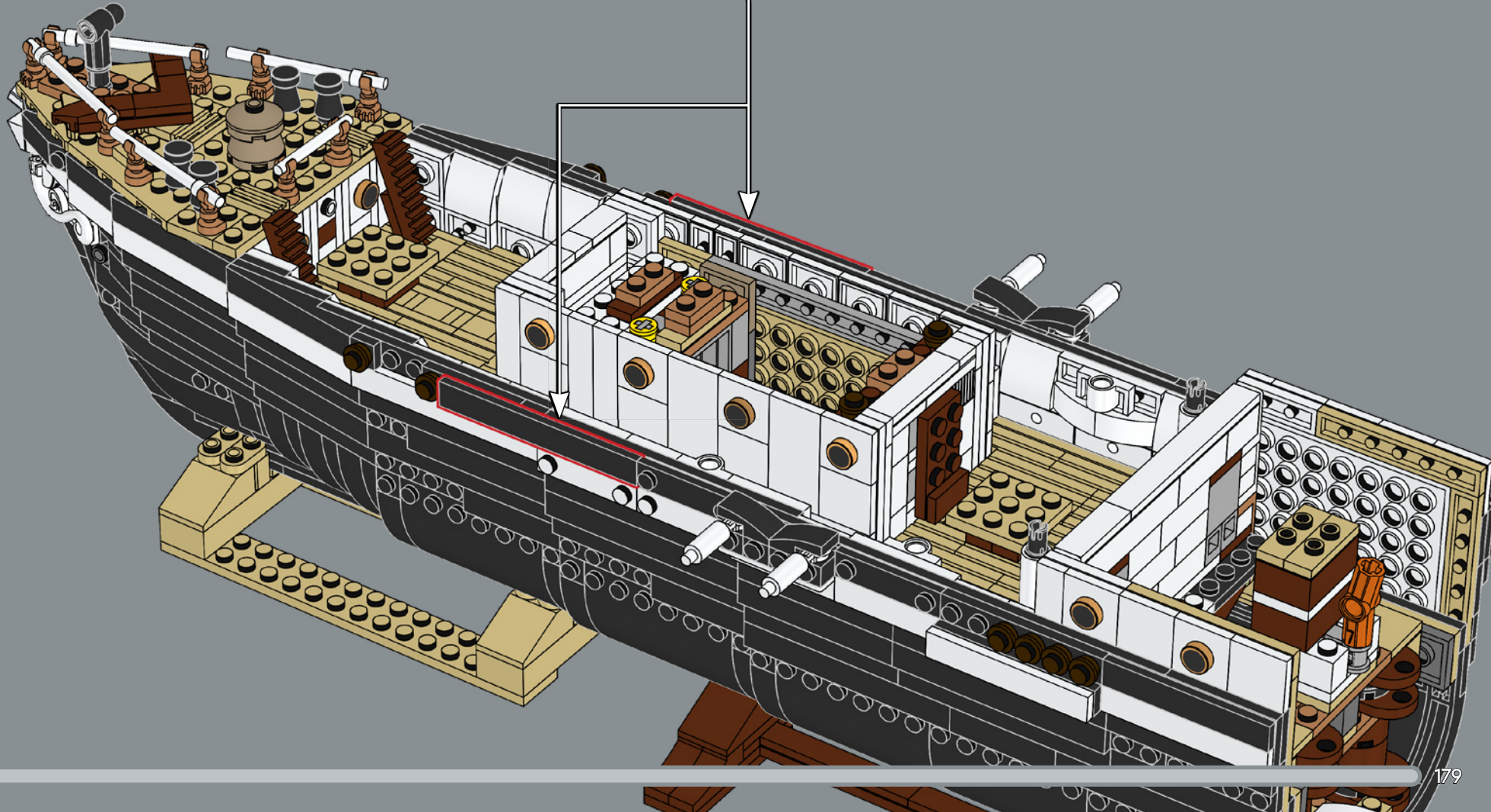
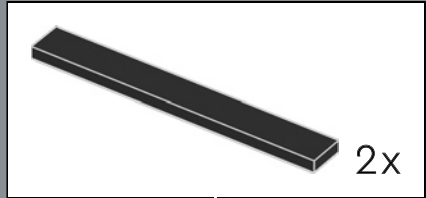

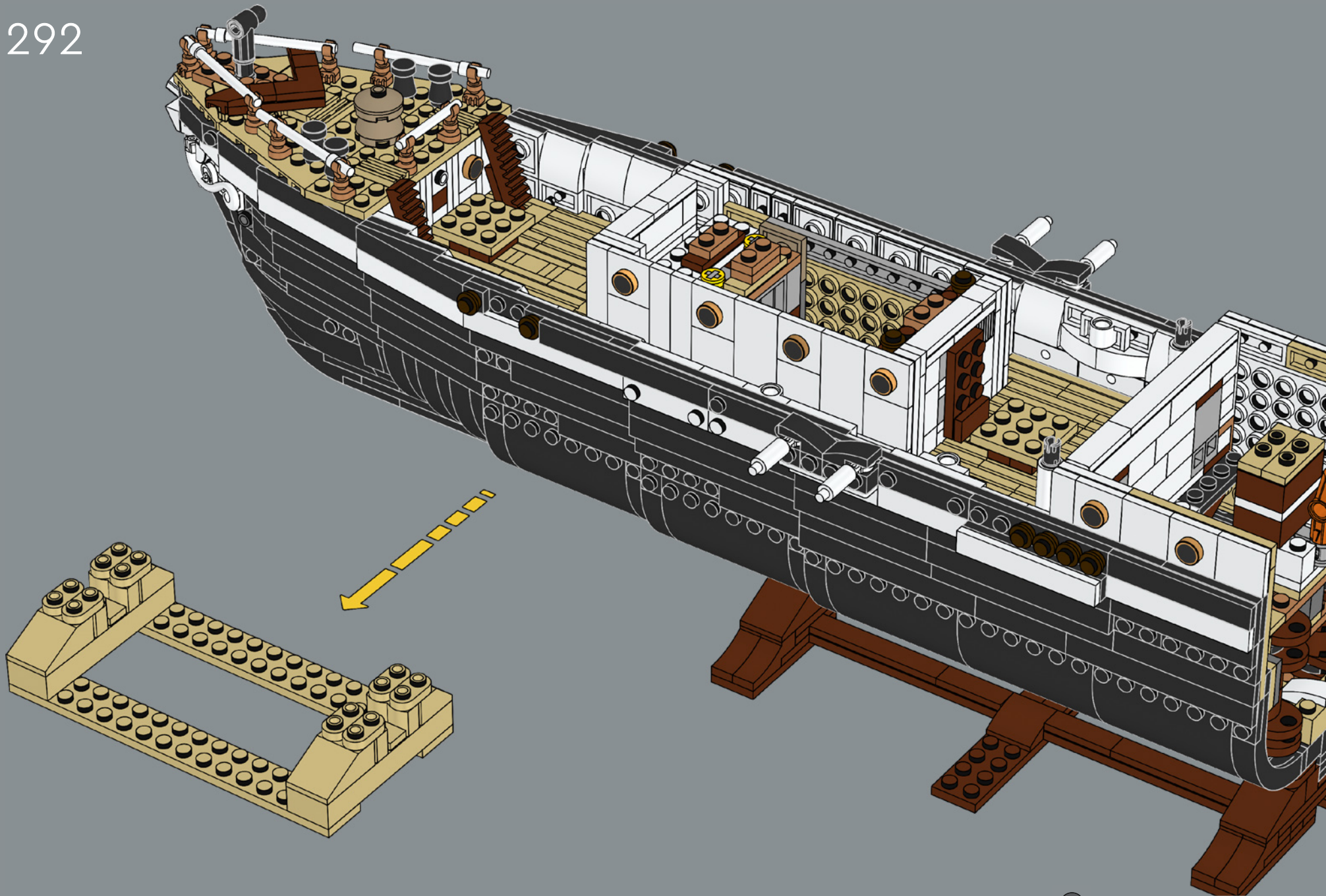

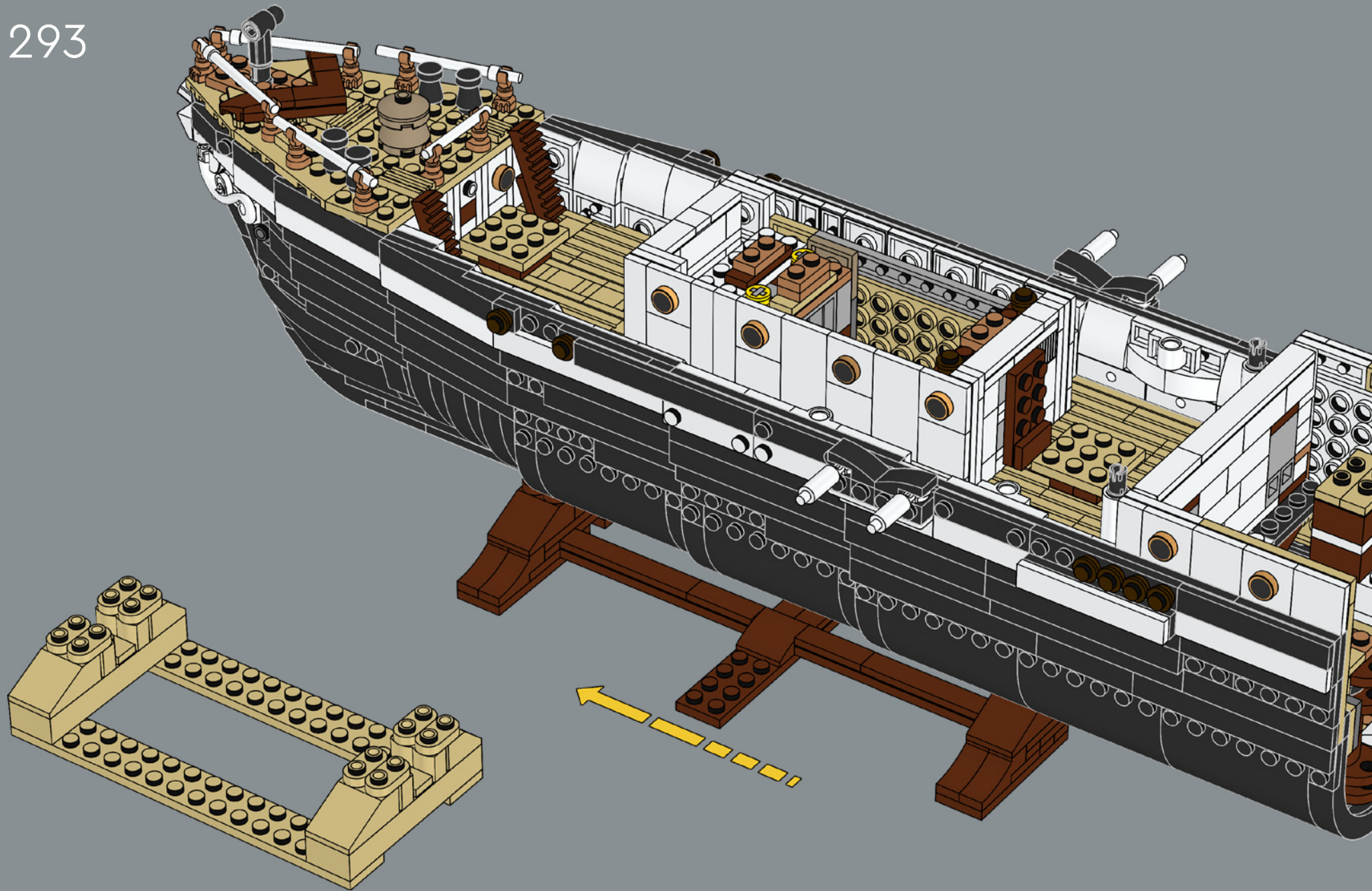

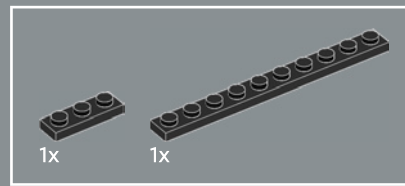
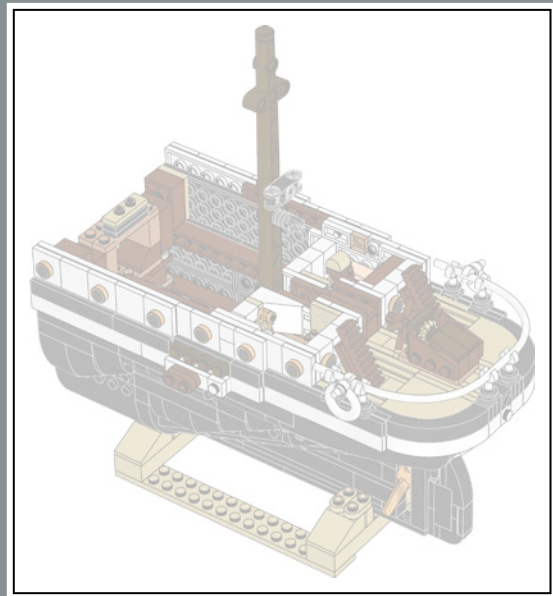
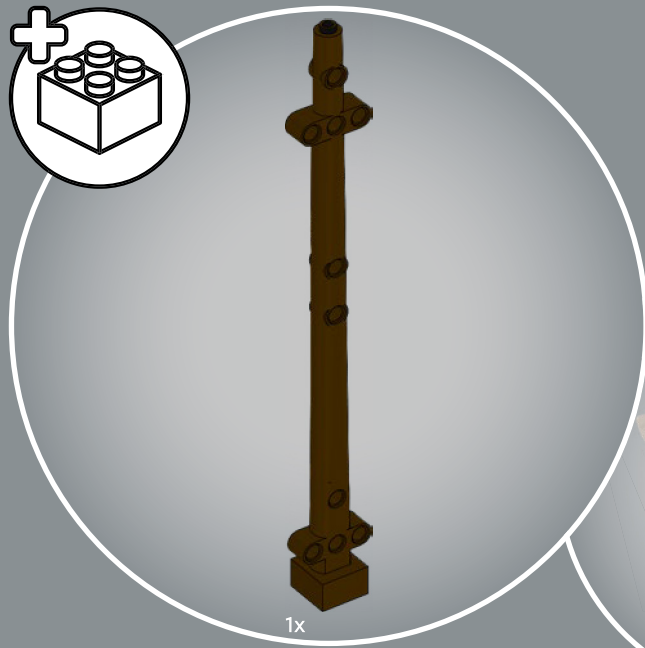
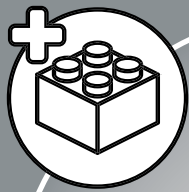

294

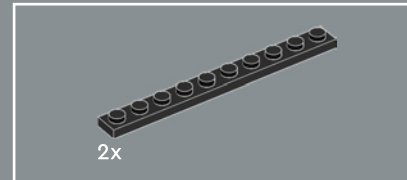
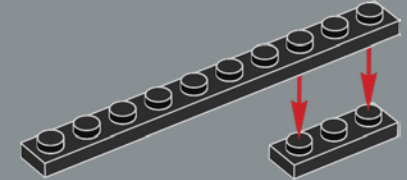

295

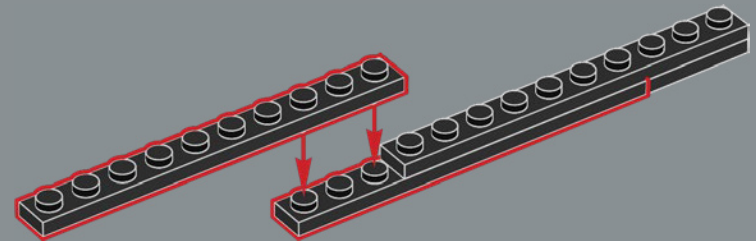

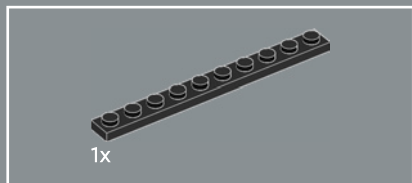

296

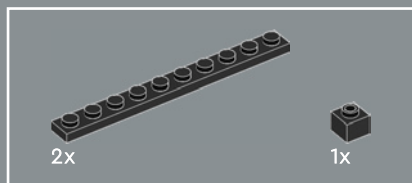
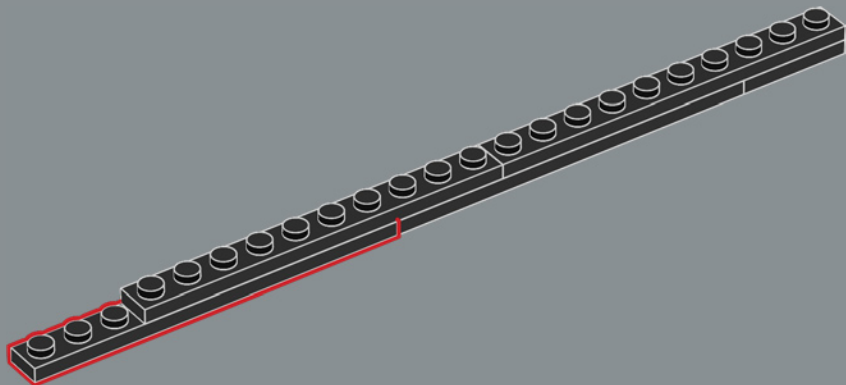

297

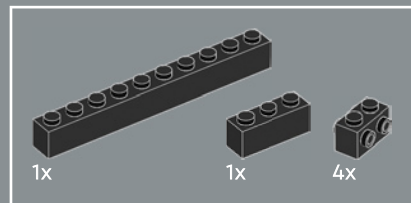
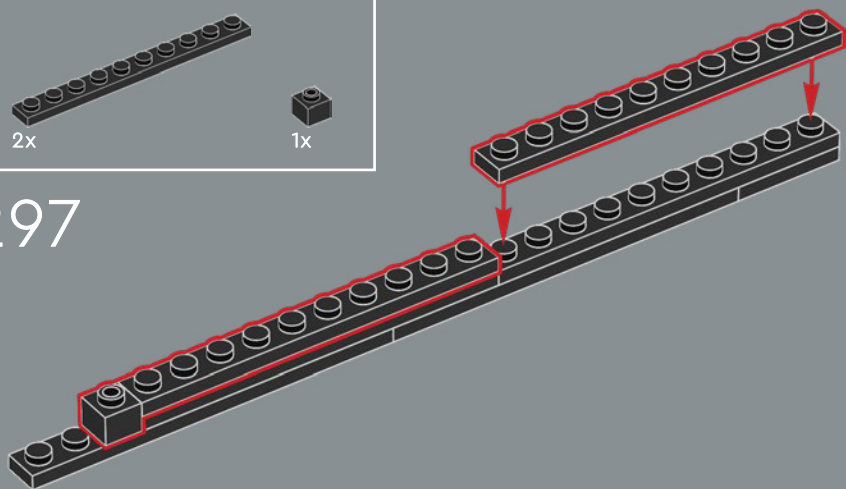

298

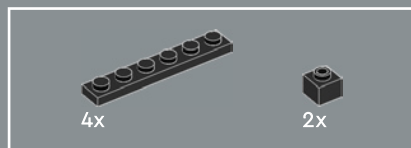
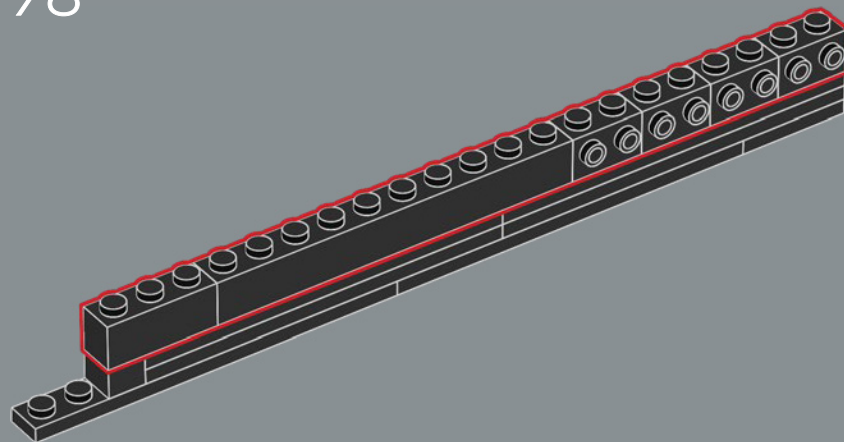

299

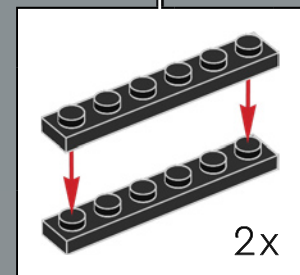
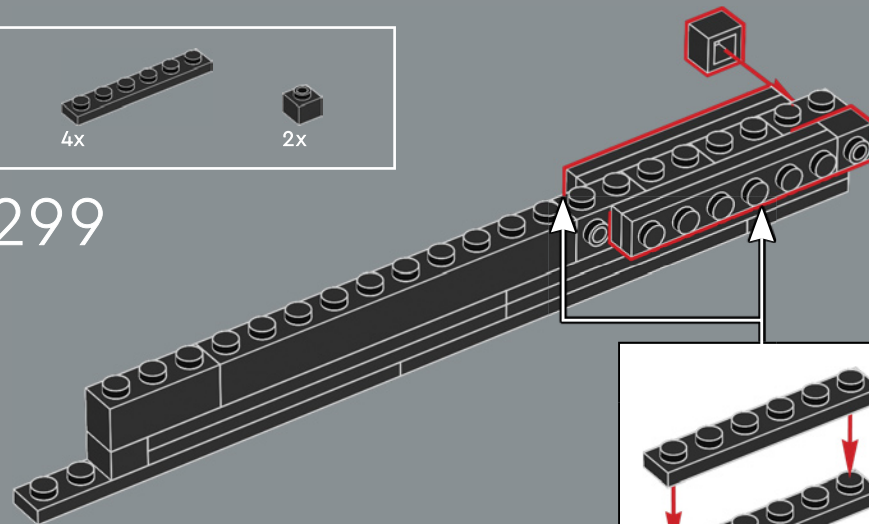

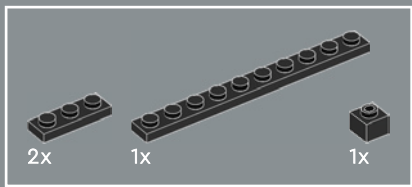

300

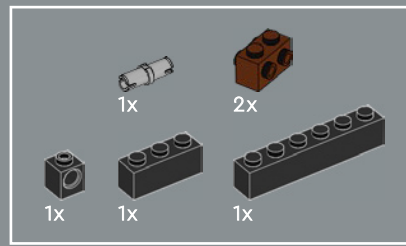
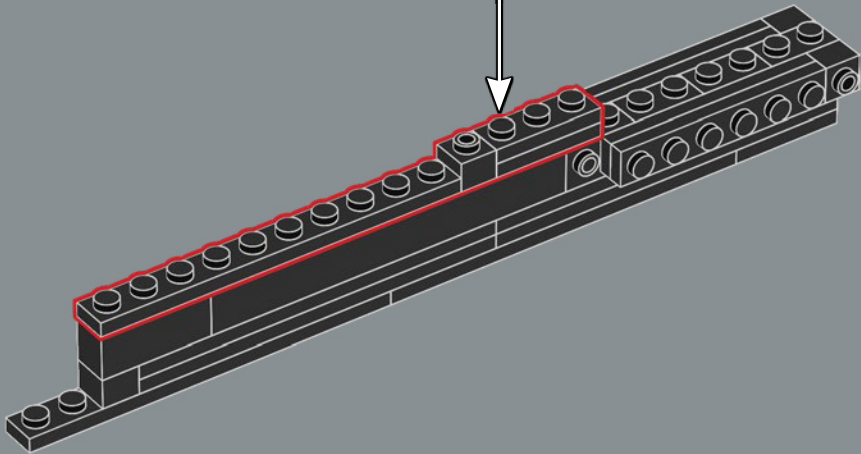
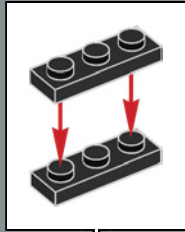

301

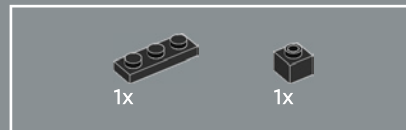
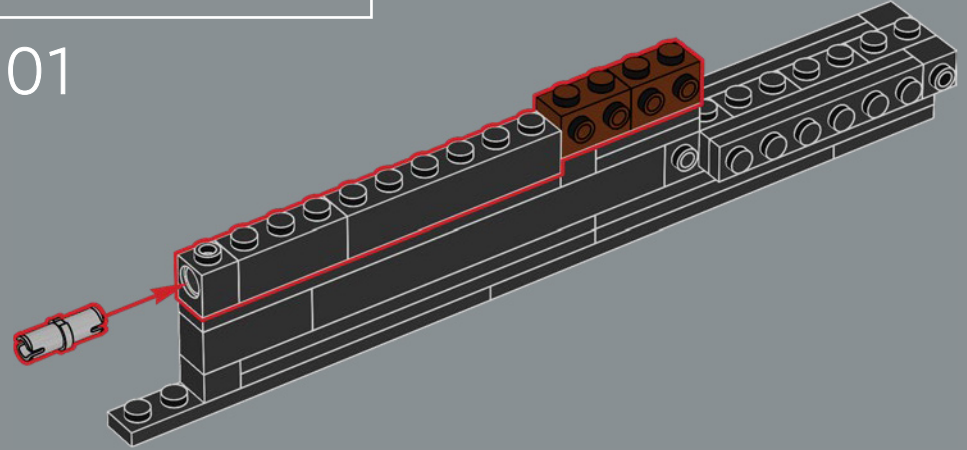

302

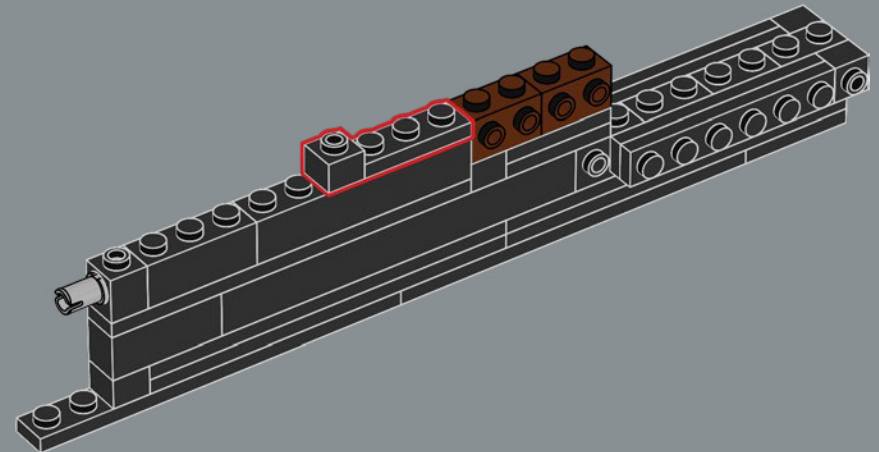

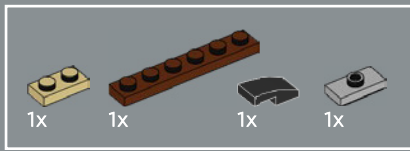

303

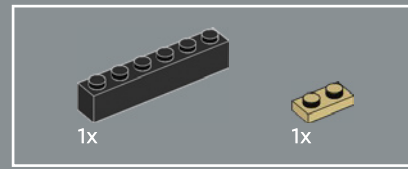
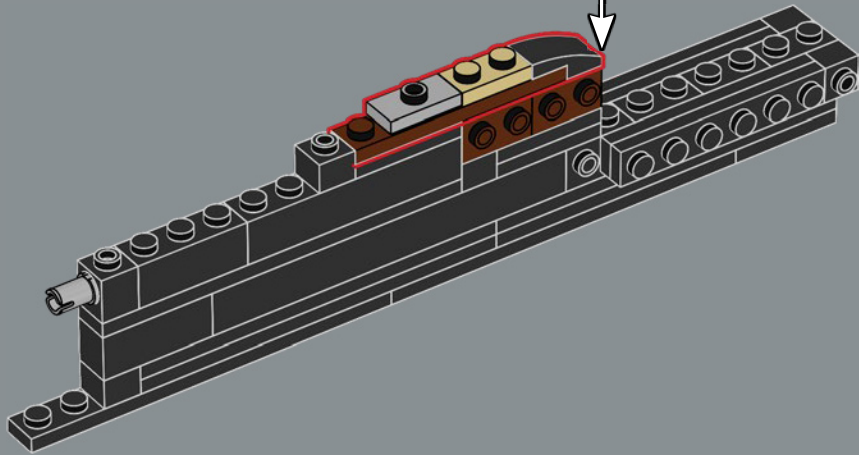
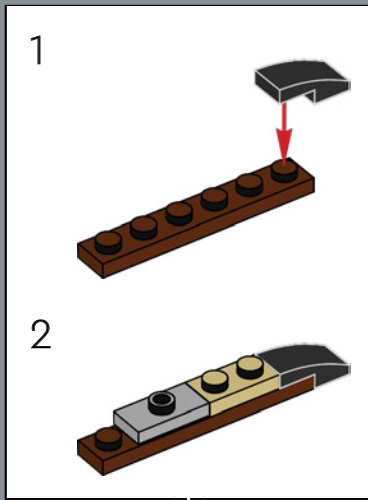

304

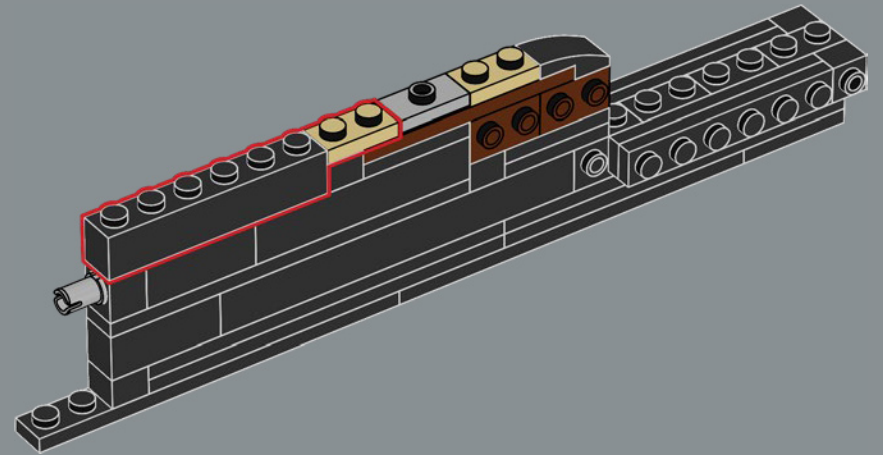



305

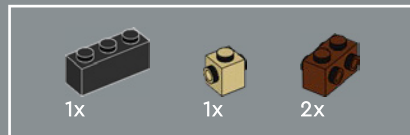
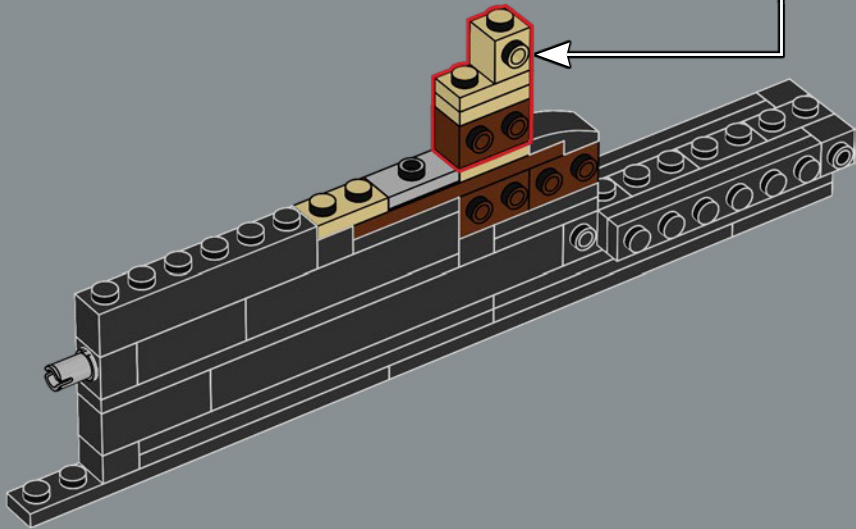
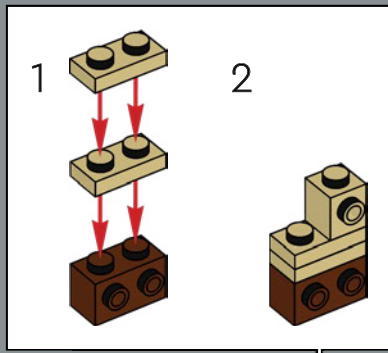

306

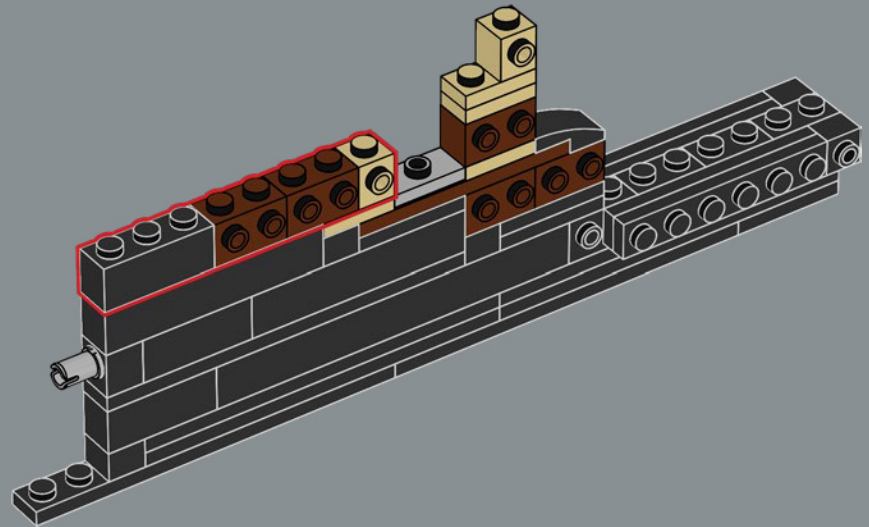

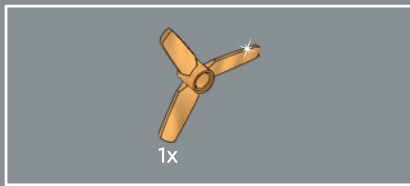

Nella vera *Endurance*, l'elica era nera, ma l'elemento LEGO® è stato realizzato in oro stampato per farlo risaltare contro lo scafo nero della nave.



307

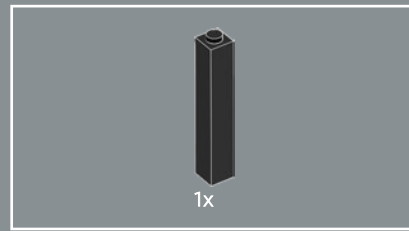
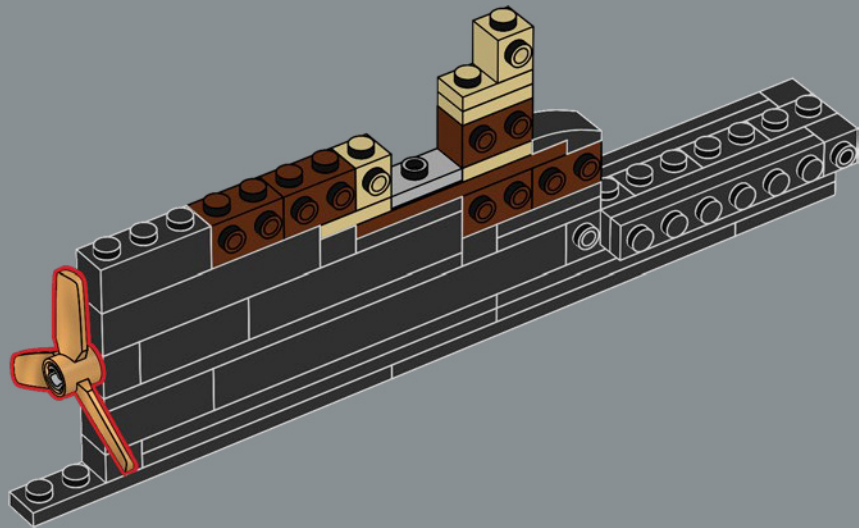

308

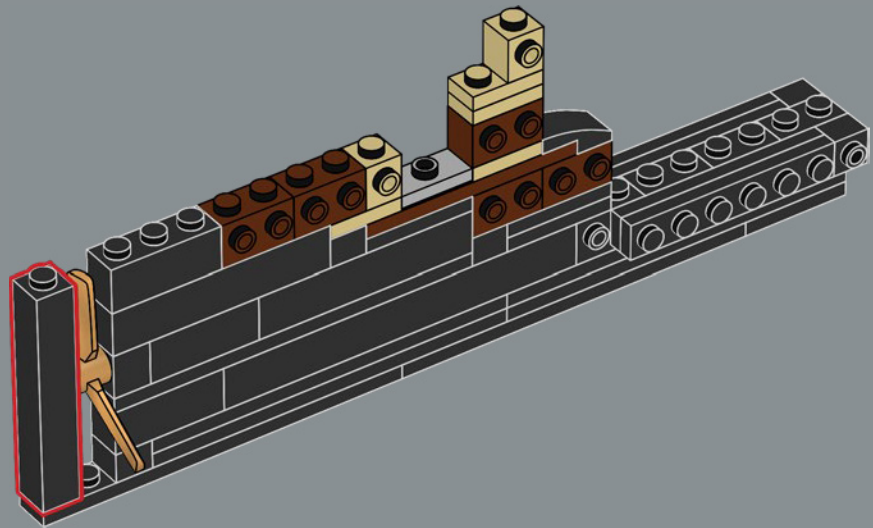

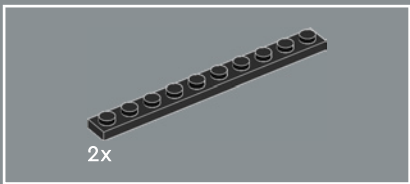

309

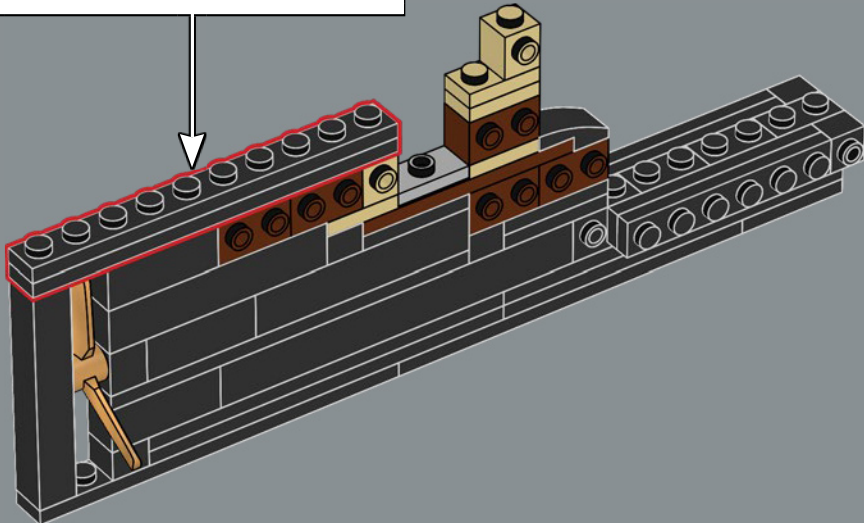
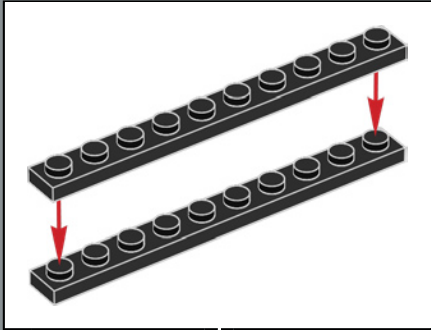

310

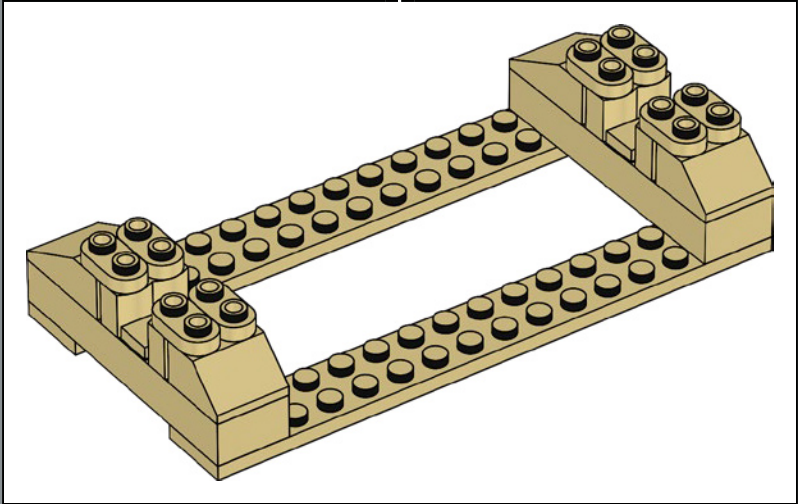
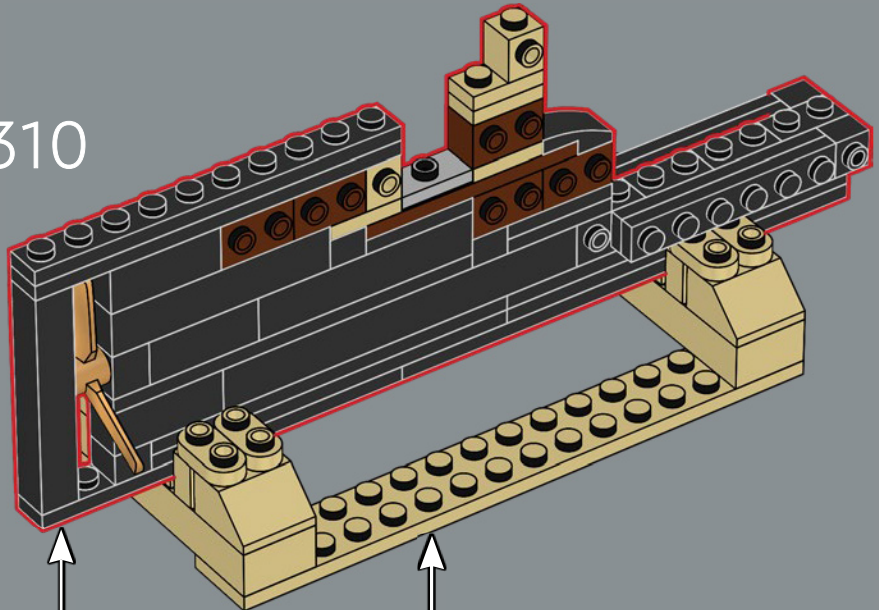

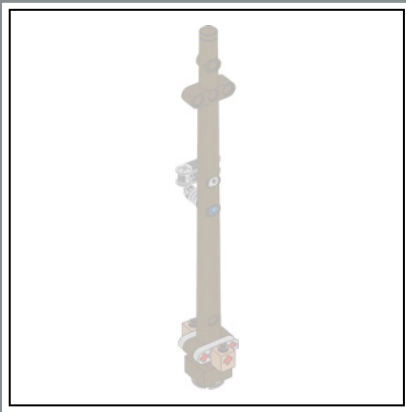

1



2

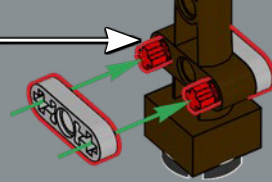
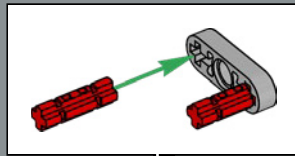

3

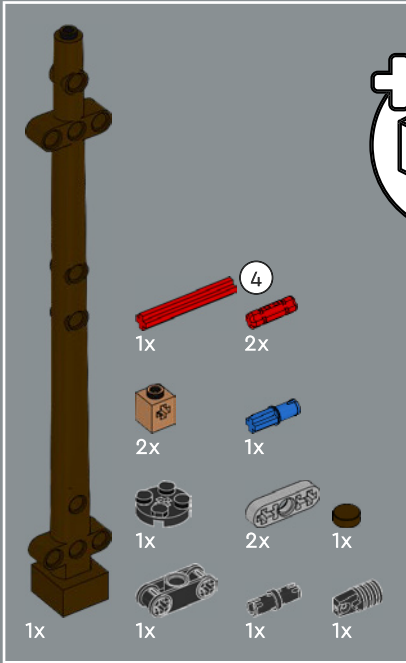
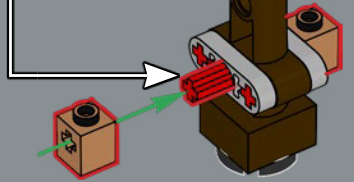
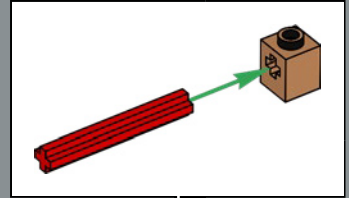

311

4

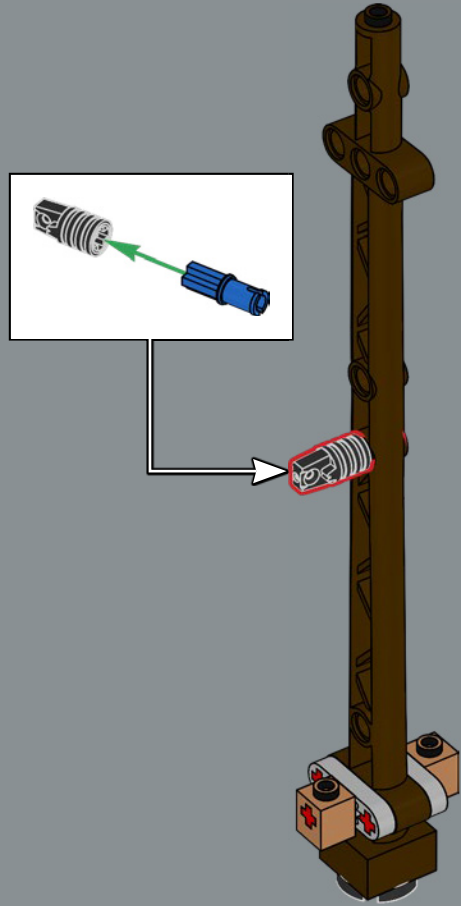

5

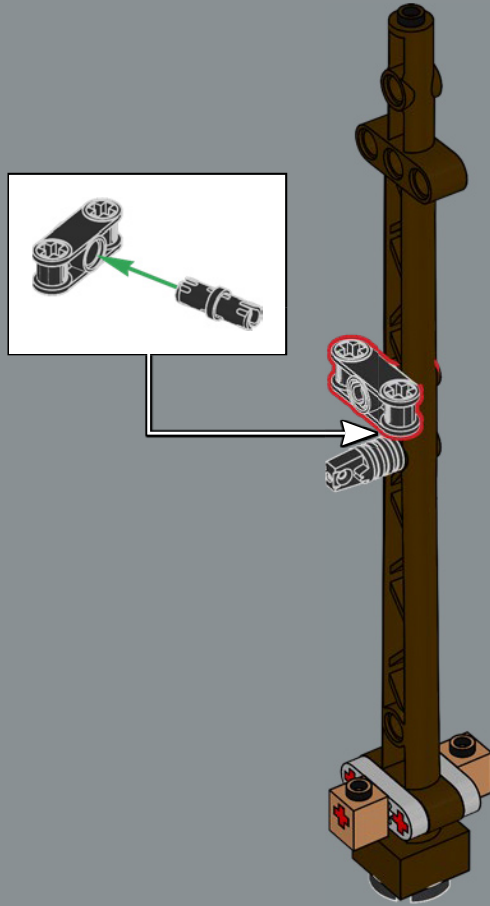

6

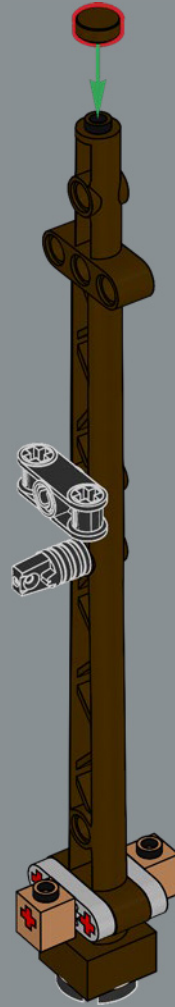

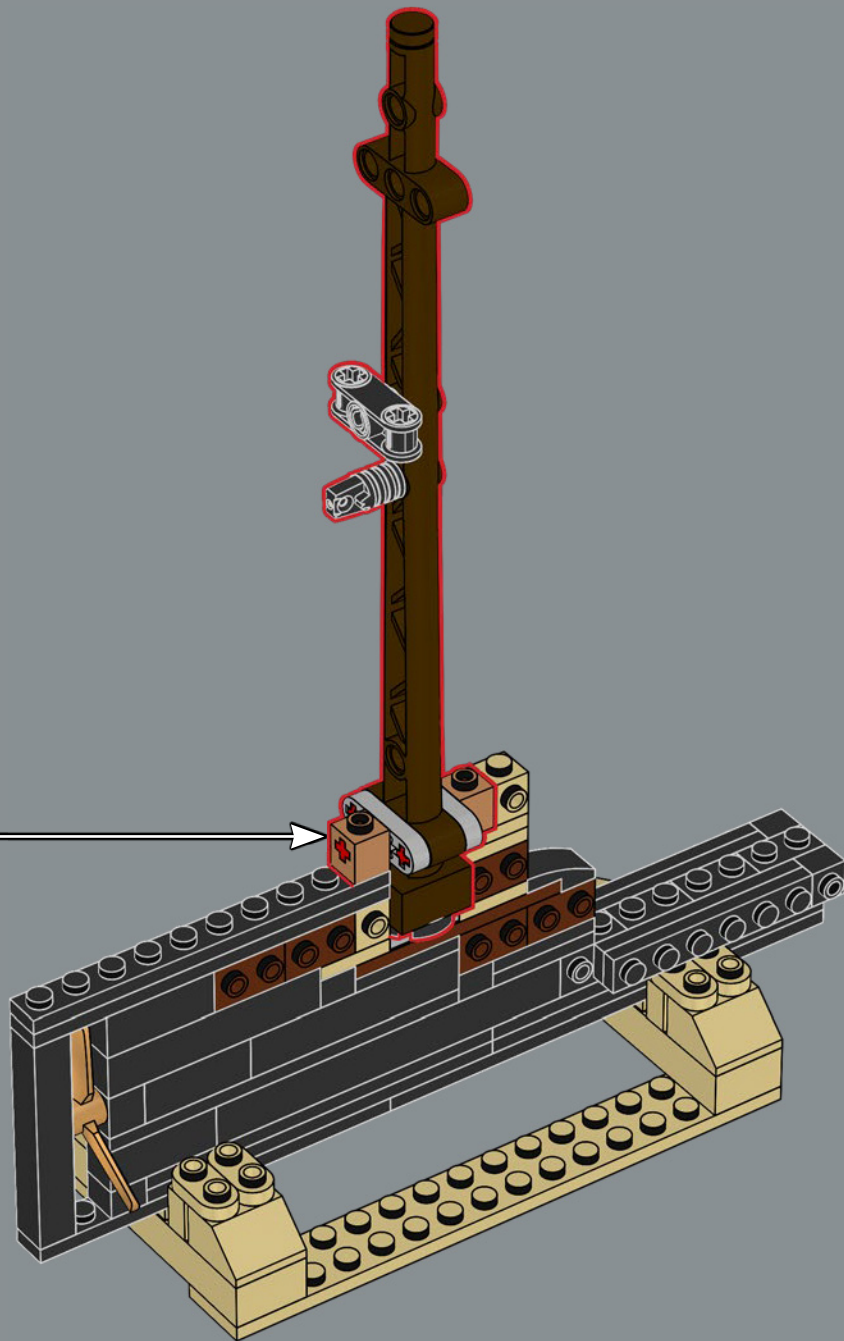

		
4x	1x	1x

312

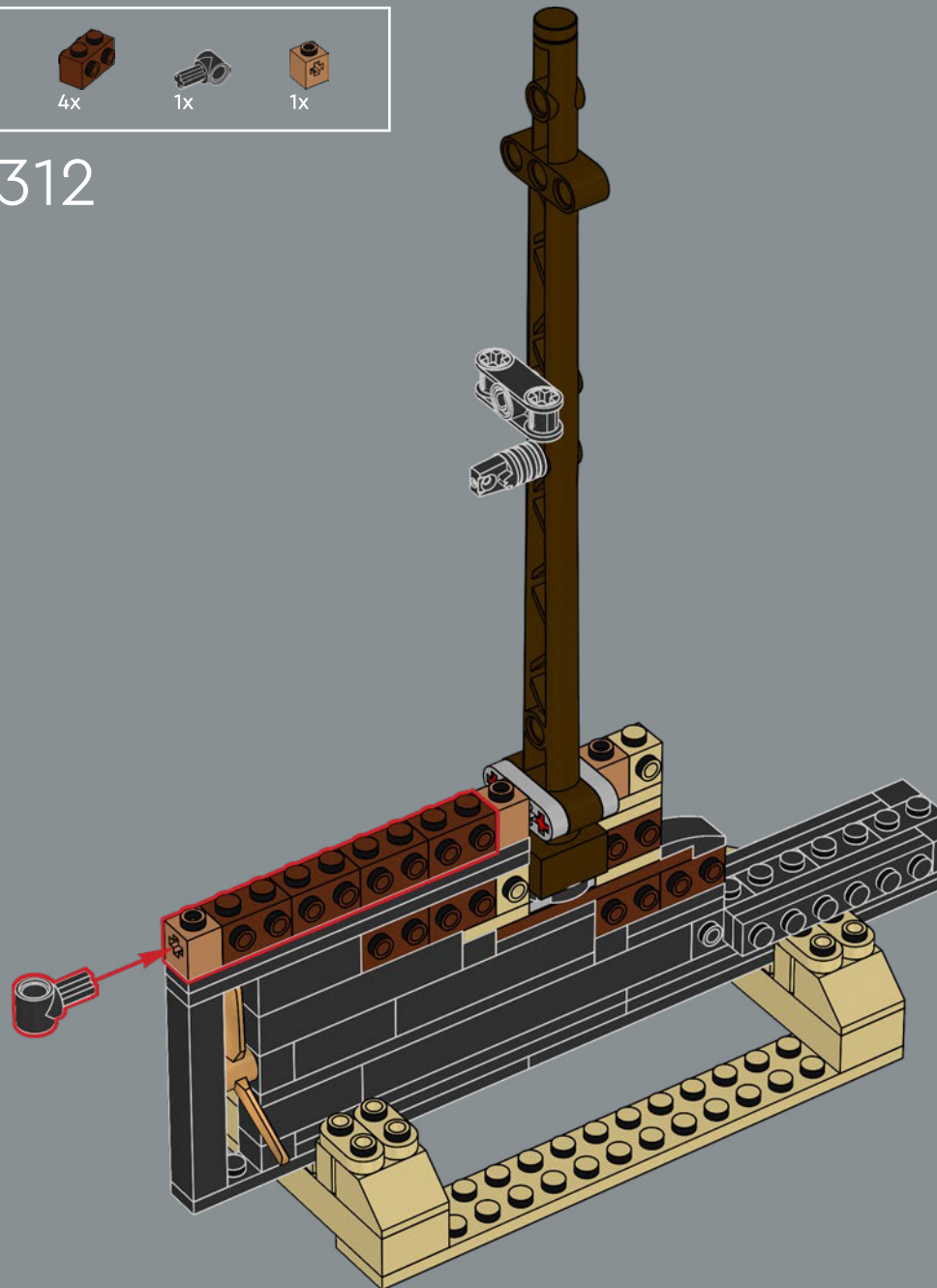

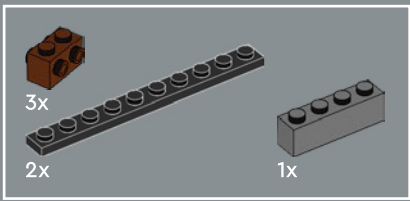

313

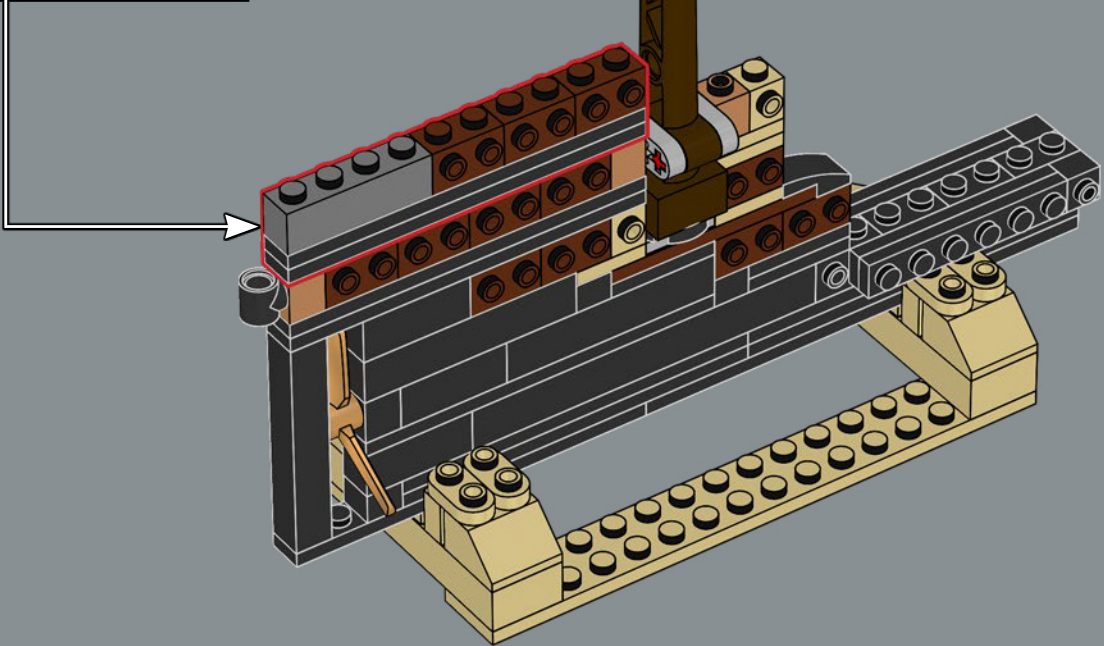
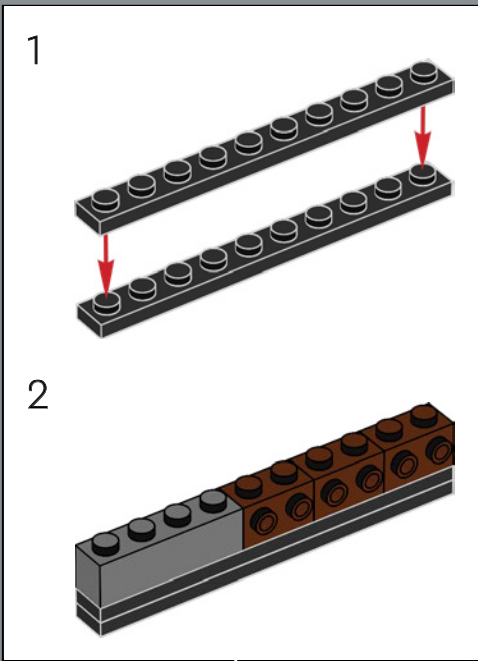

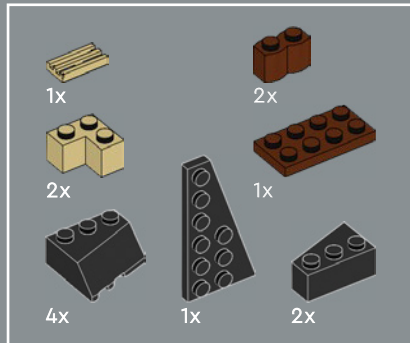
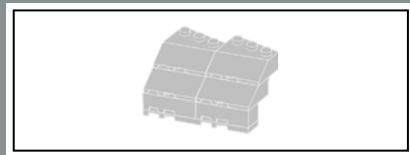

314

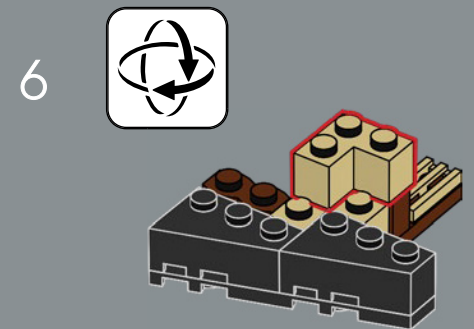
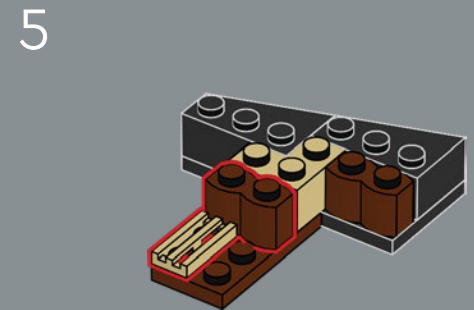
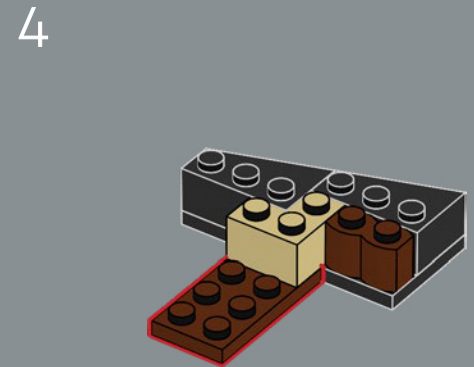
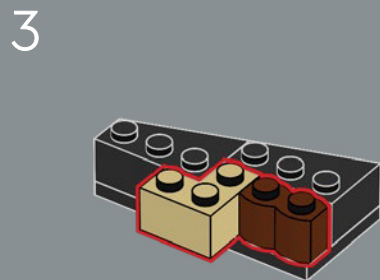
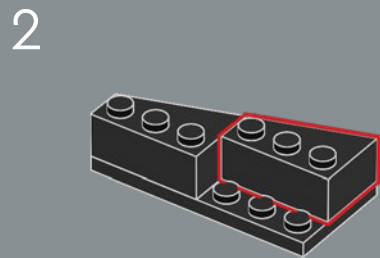
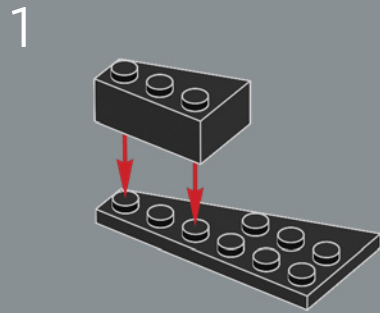

7

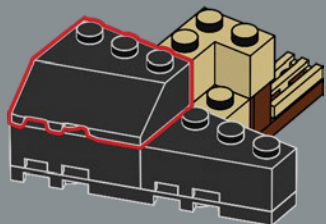

8

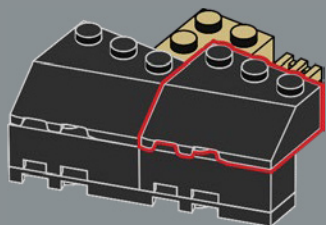

9

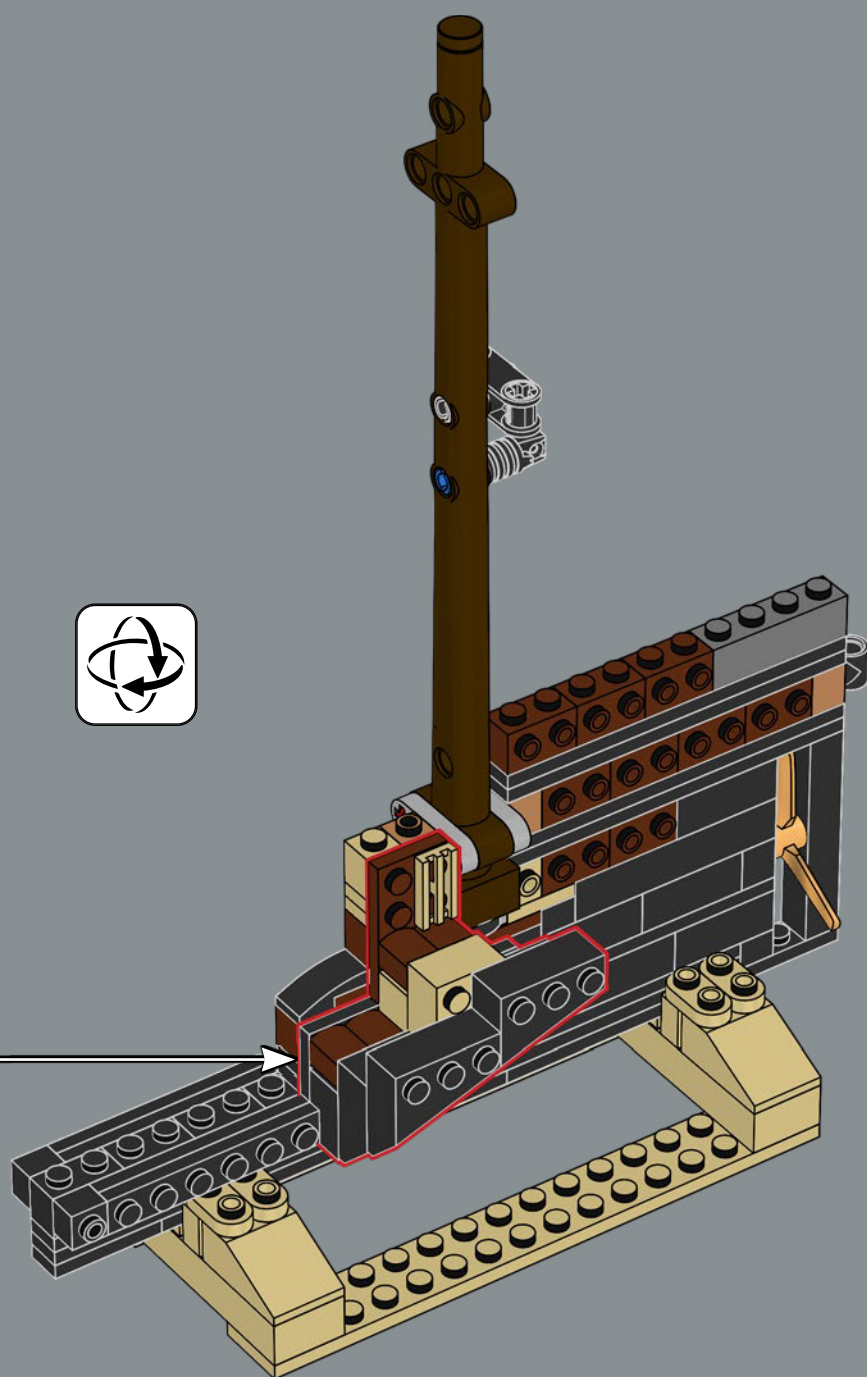
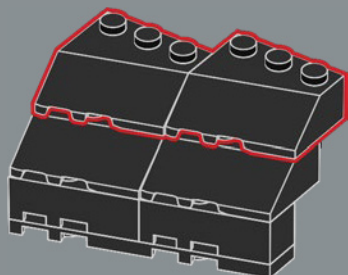

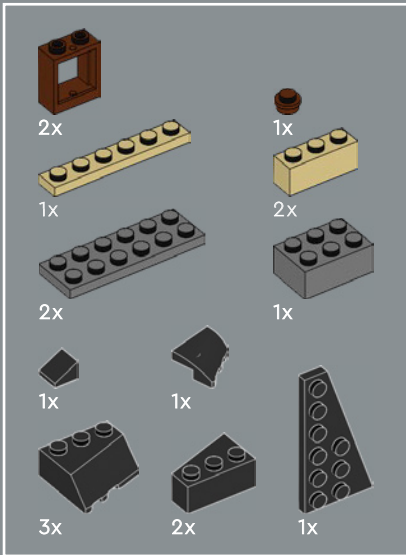
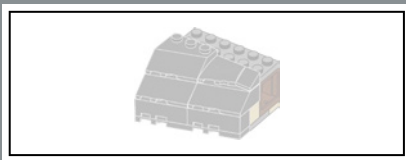

315

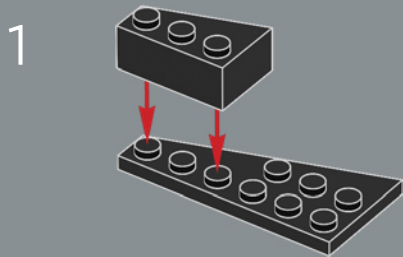

2

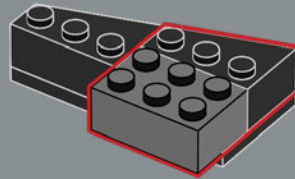

3

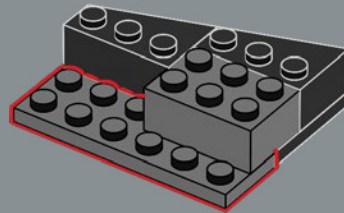

4

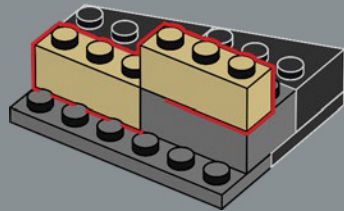

5

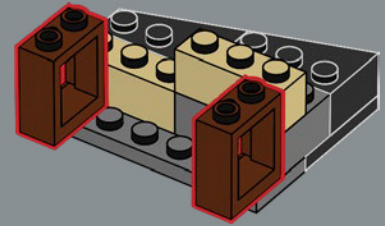

6

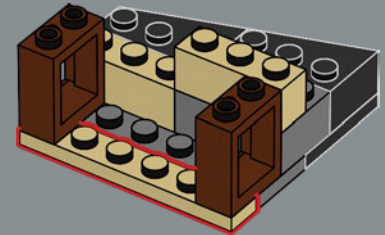

7

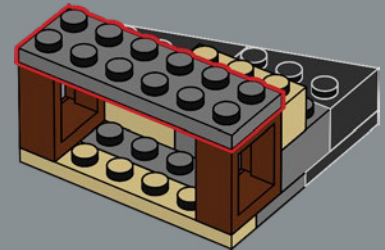

8

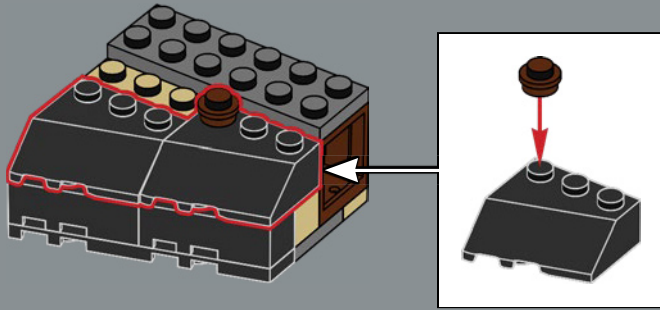

9

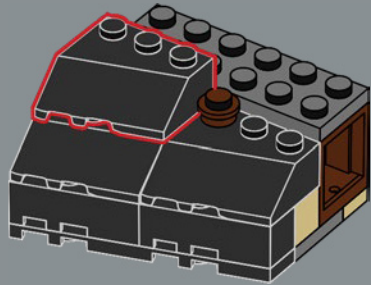

10

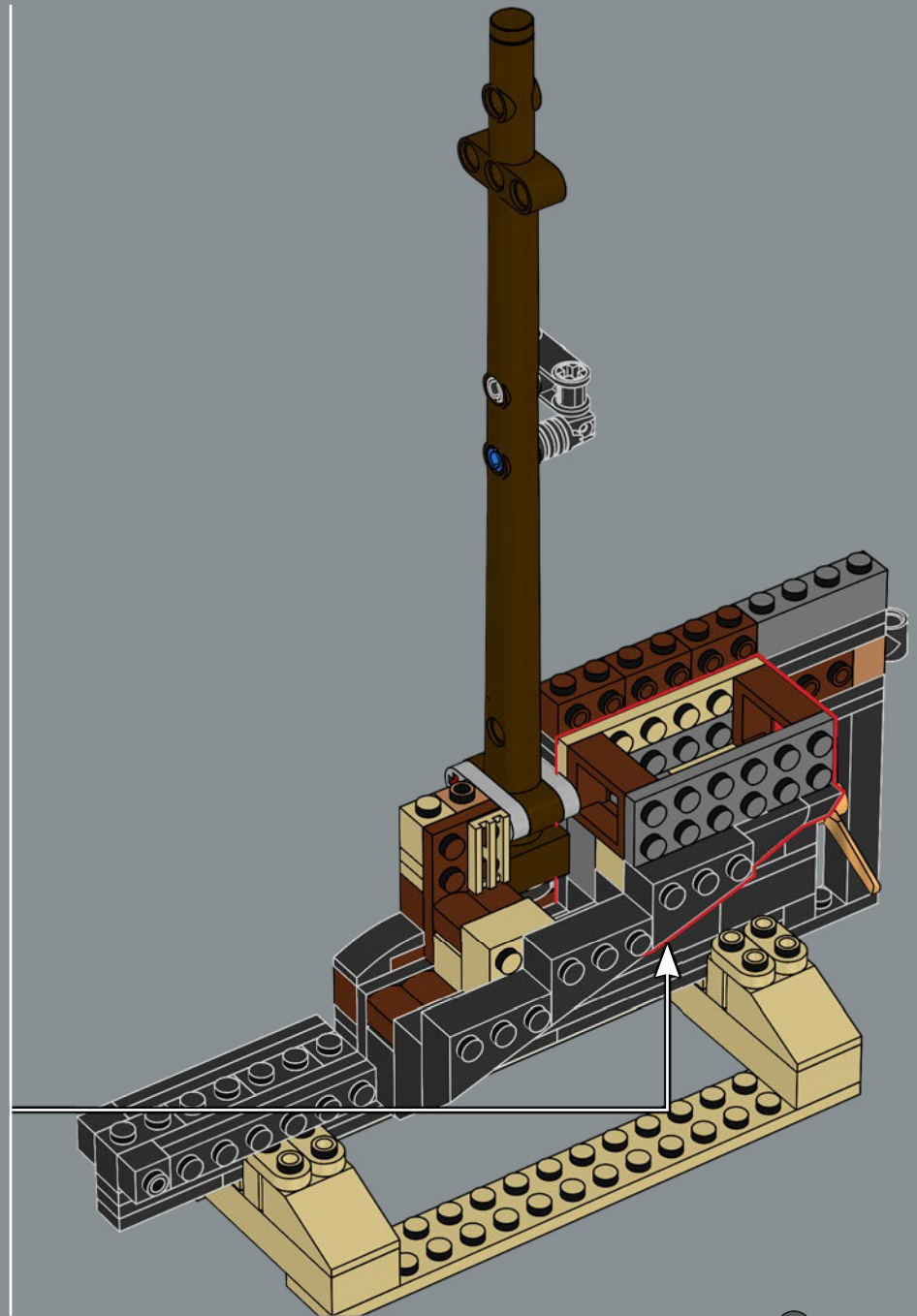
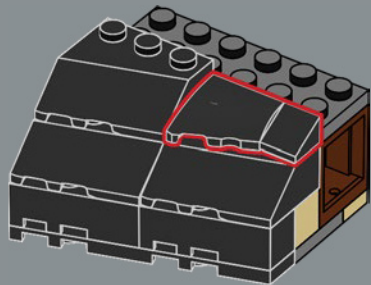

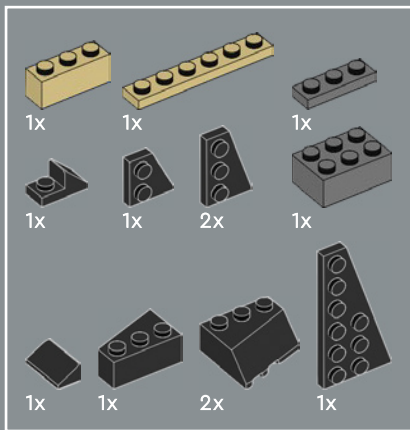

316

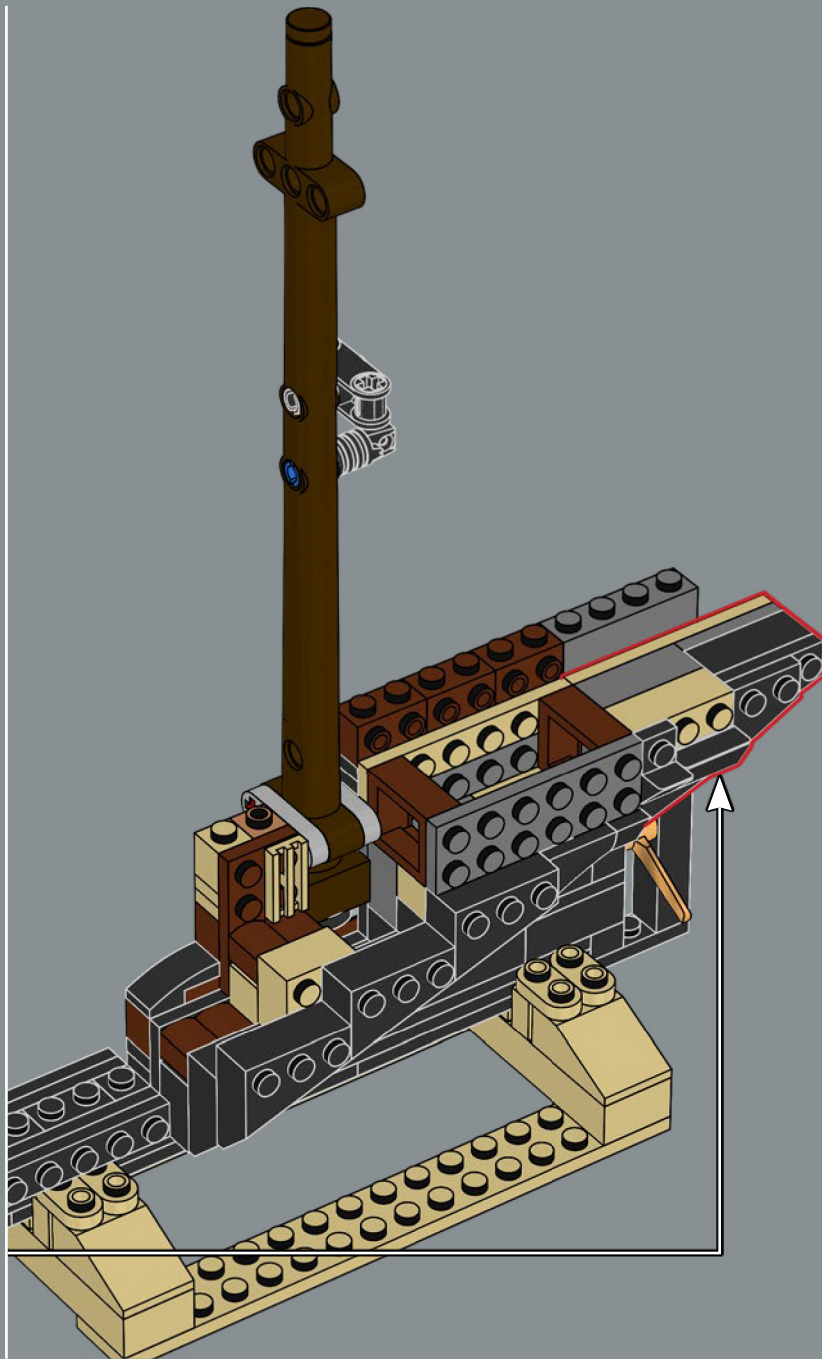
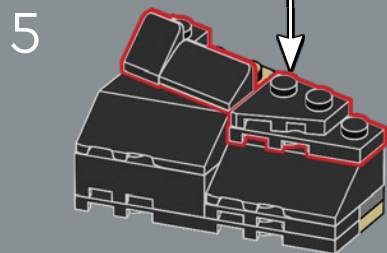
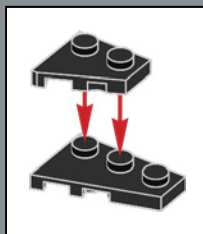
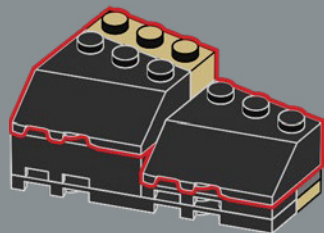
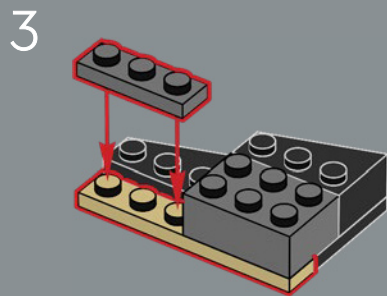
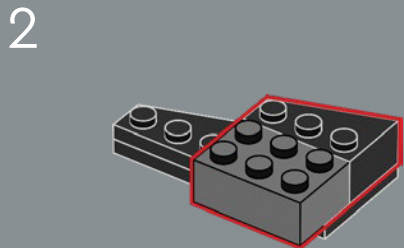
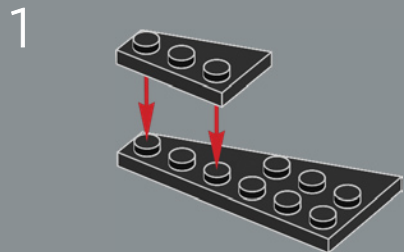

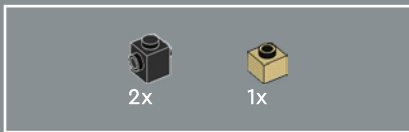

317

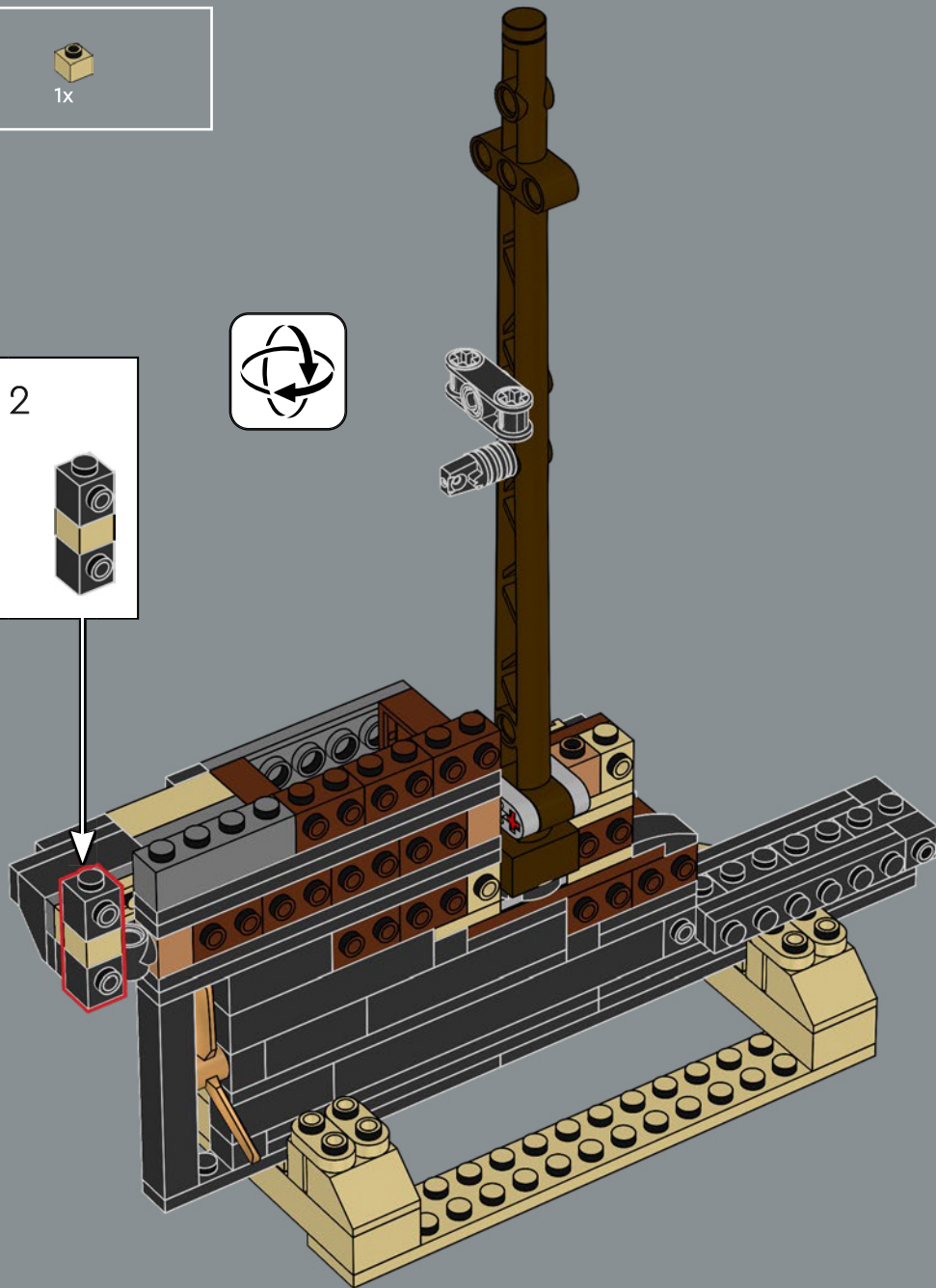
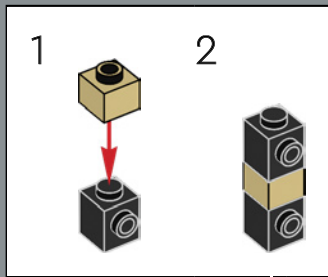

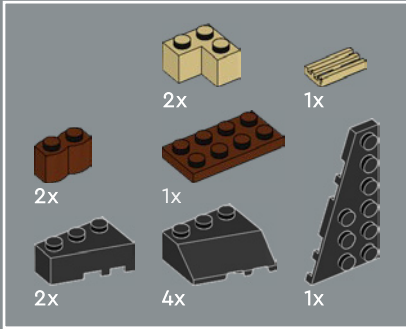
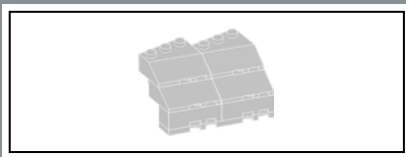

318

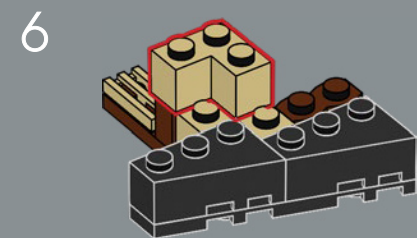
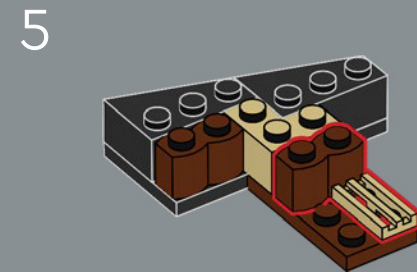
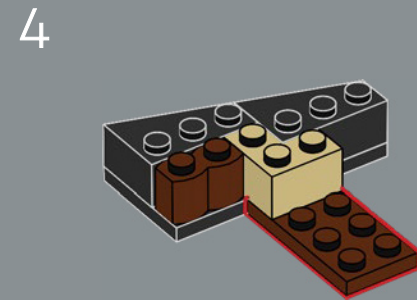
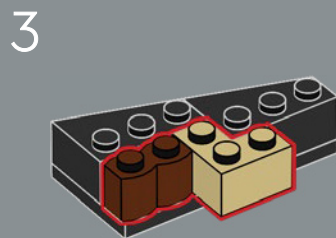
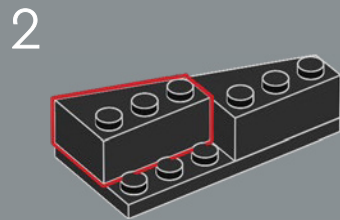
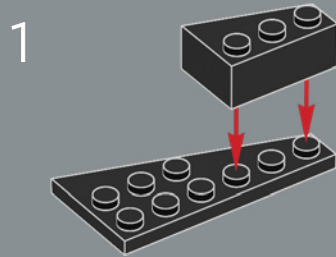

7

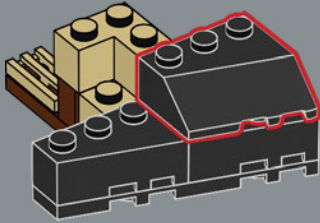

8

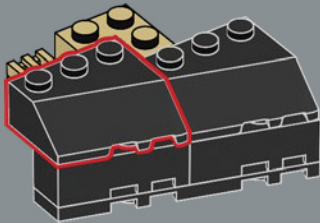

9

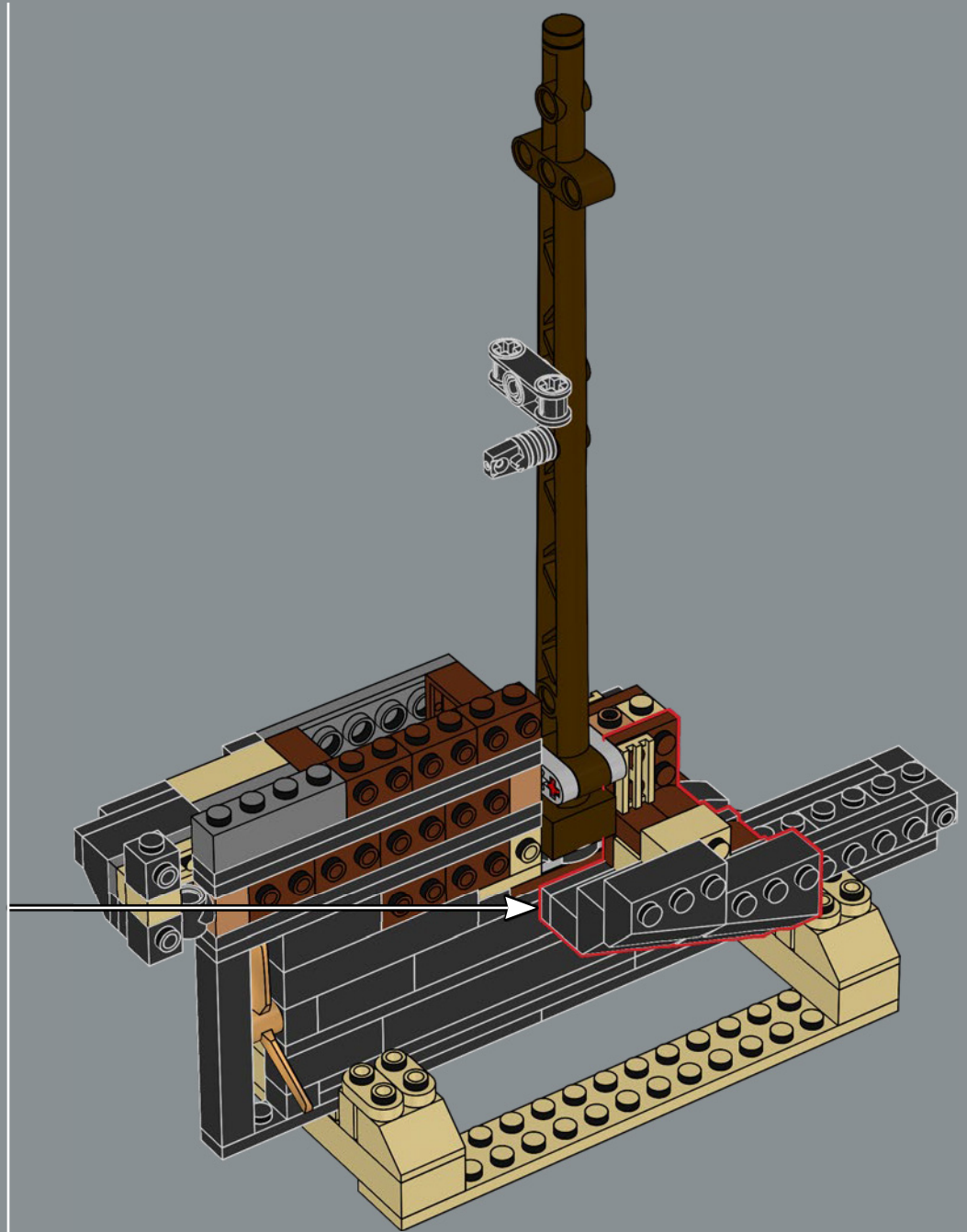
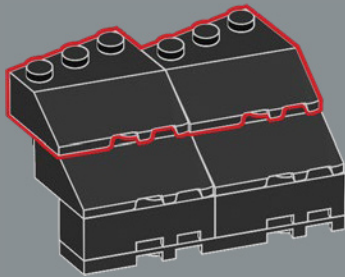

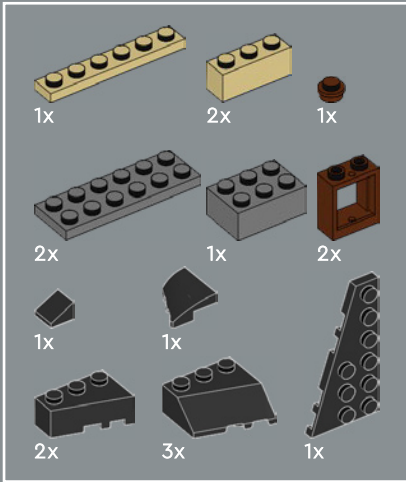
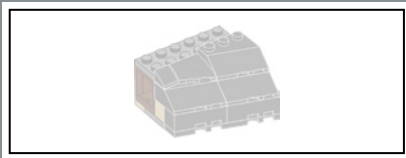

319

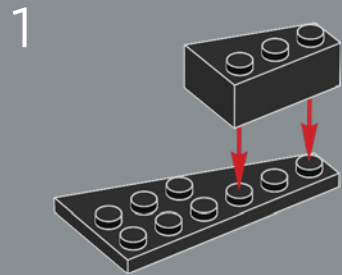

2

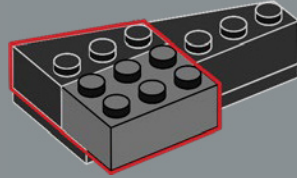

3

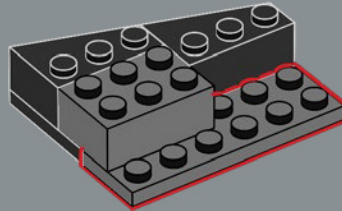

4

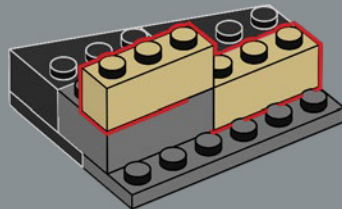

5

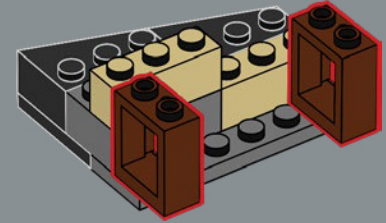

6

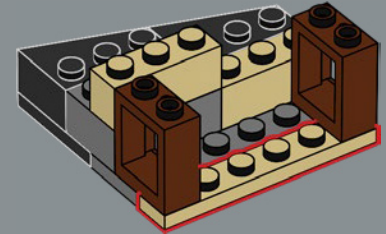

7

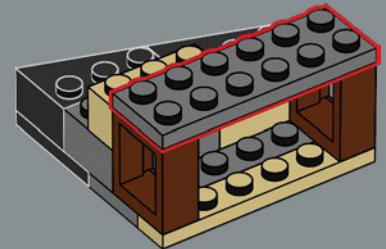

8

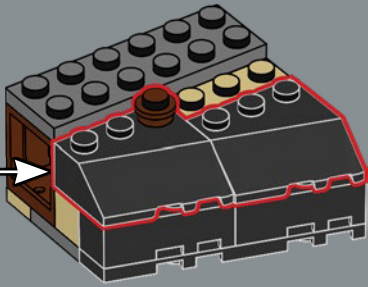
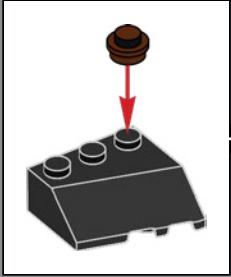

9

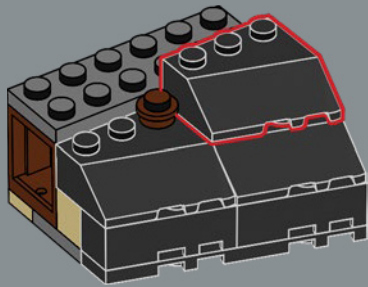

10

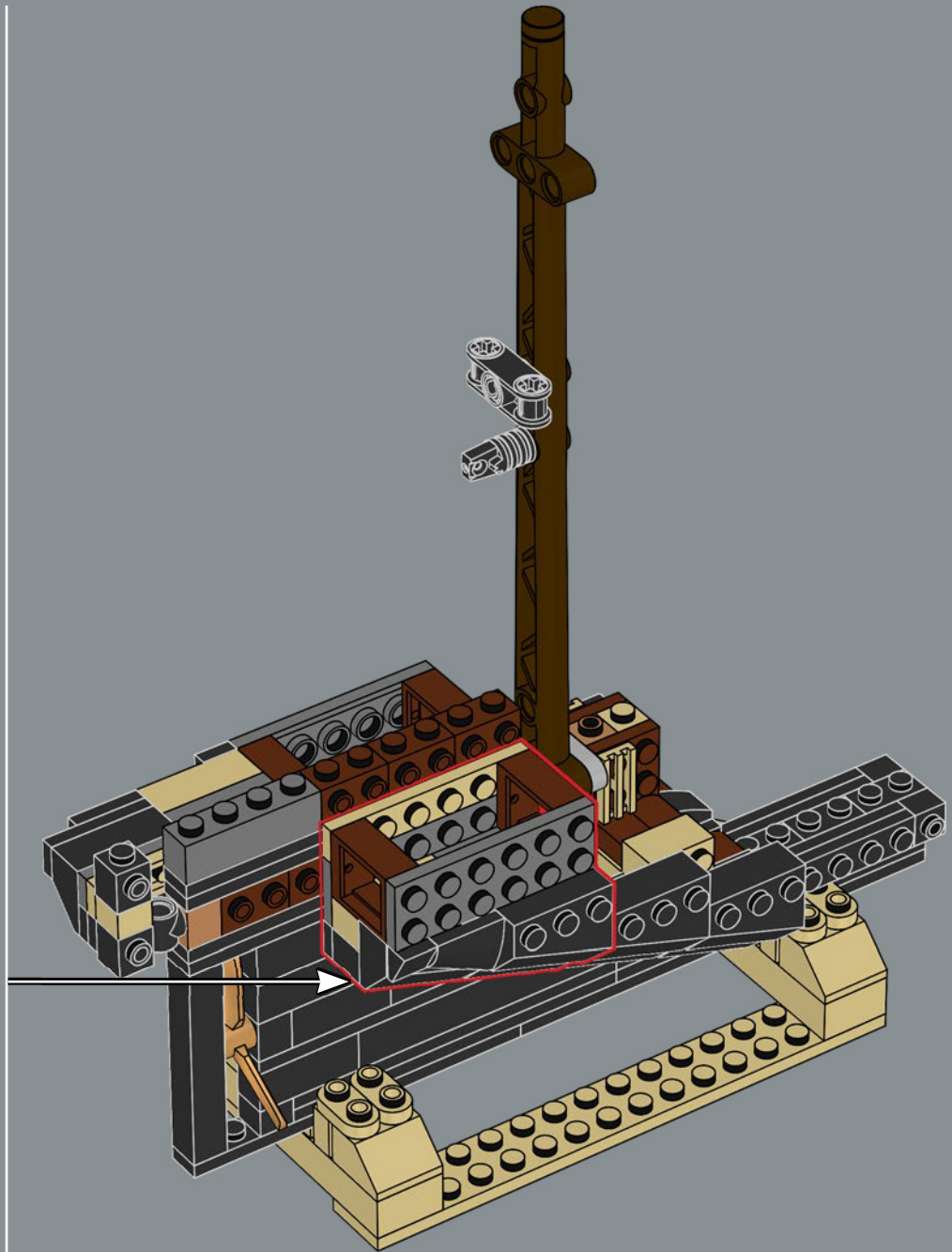
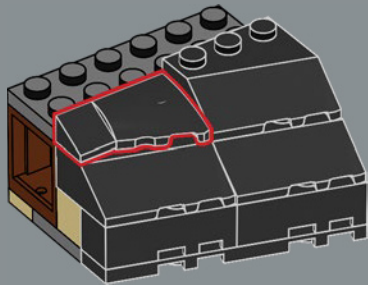

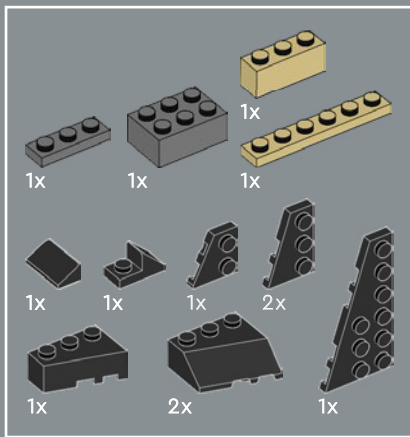

320

1

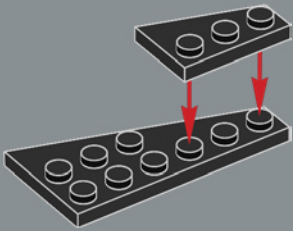

2

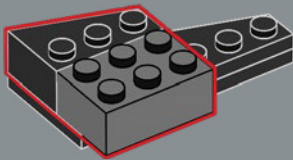

3

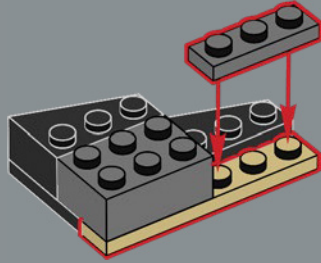

4

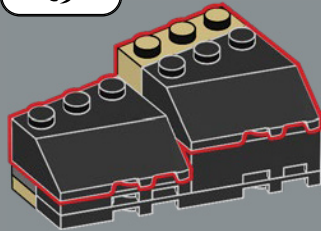

5

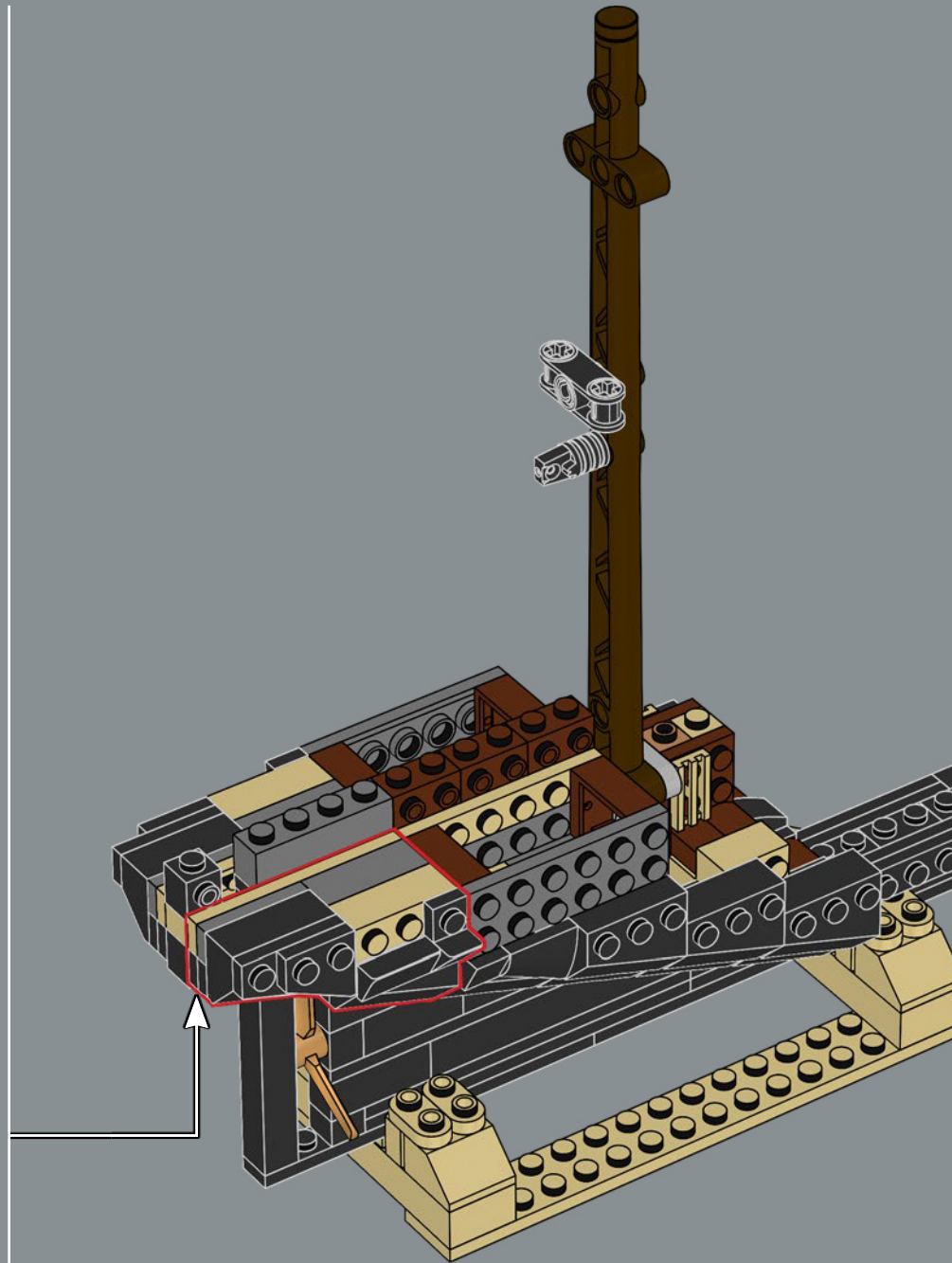
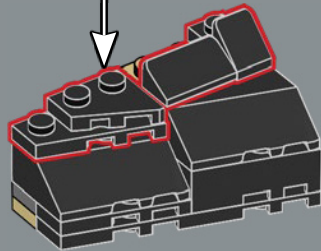
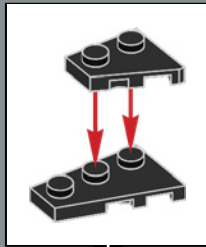



321

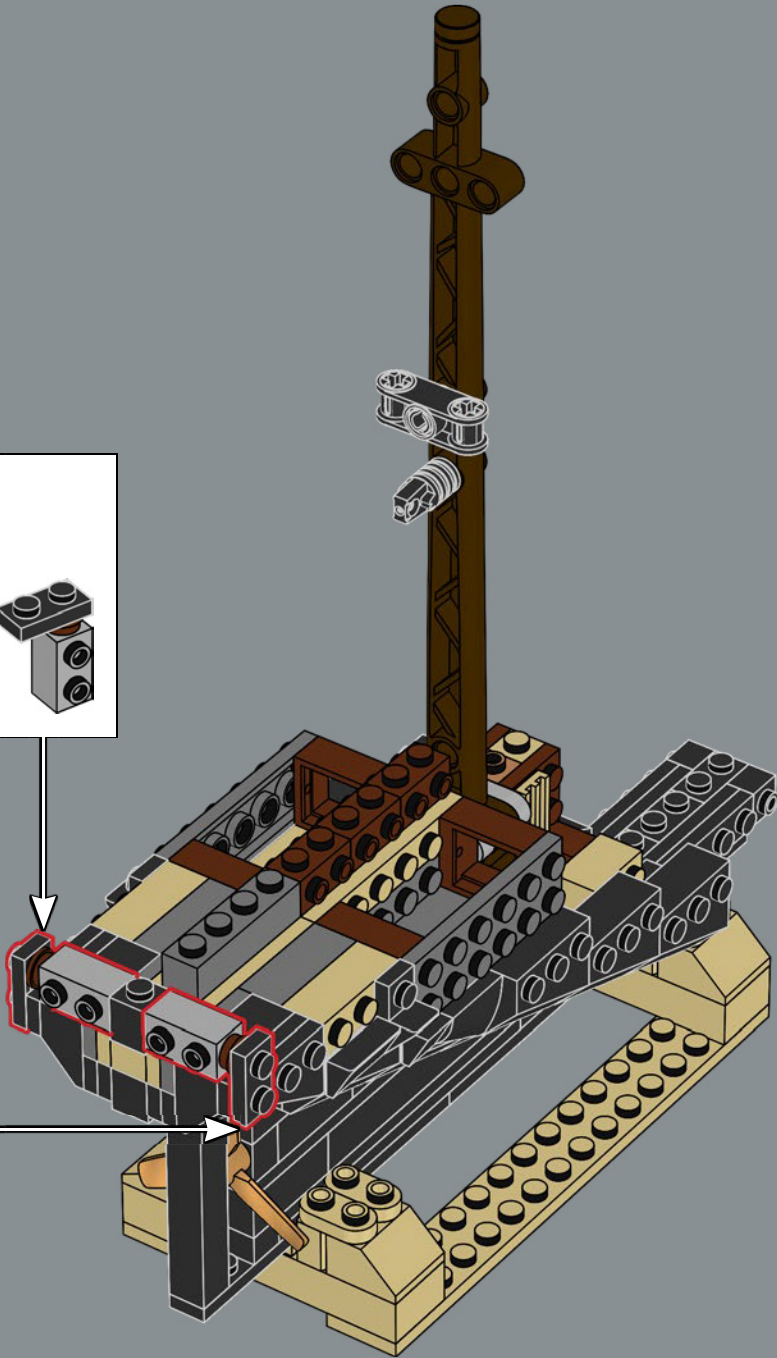
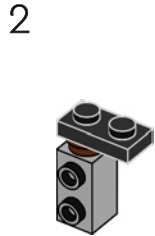
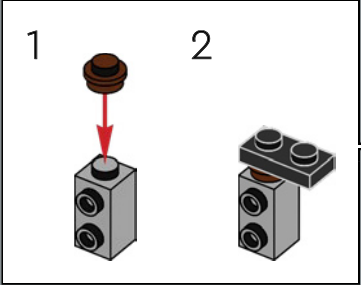
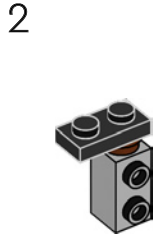
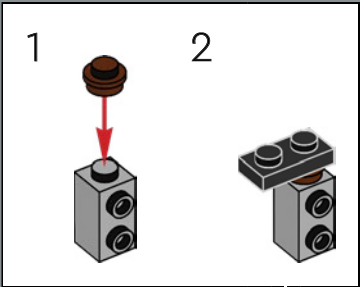

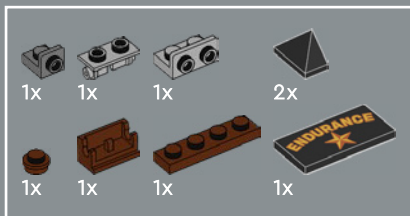

322

1

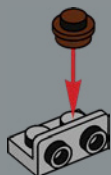

2

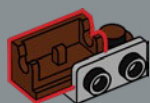

3

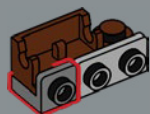

4

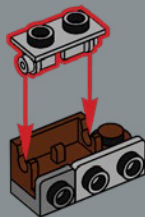

5

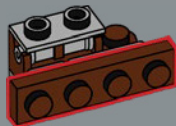

6

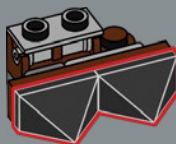

7



L'*Endurance* si chiamava originariamente *Polaris*. Non è noto se Shackleton considerasse il nome della Stella Polare non idoneo per una spedizione al Polo Sud o se si sia ispirato al motto della sua famiglia, "By Endurance We Conquer". In ogni caso, la stella fu preservata!

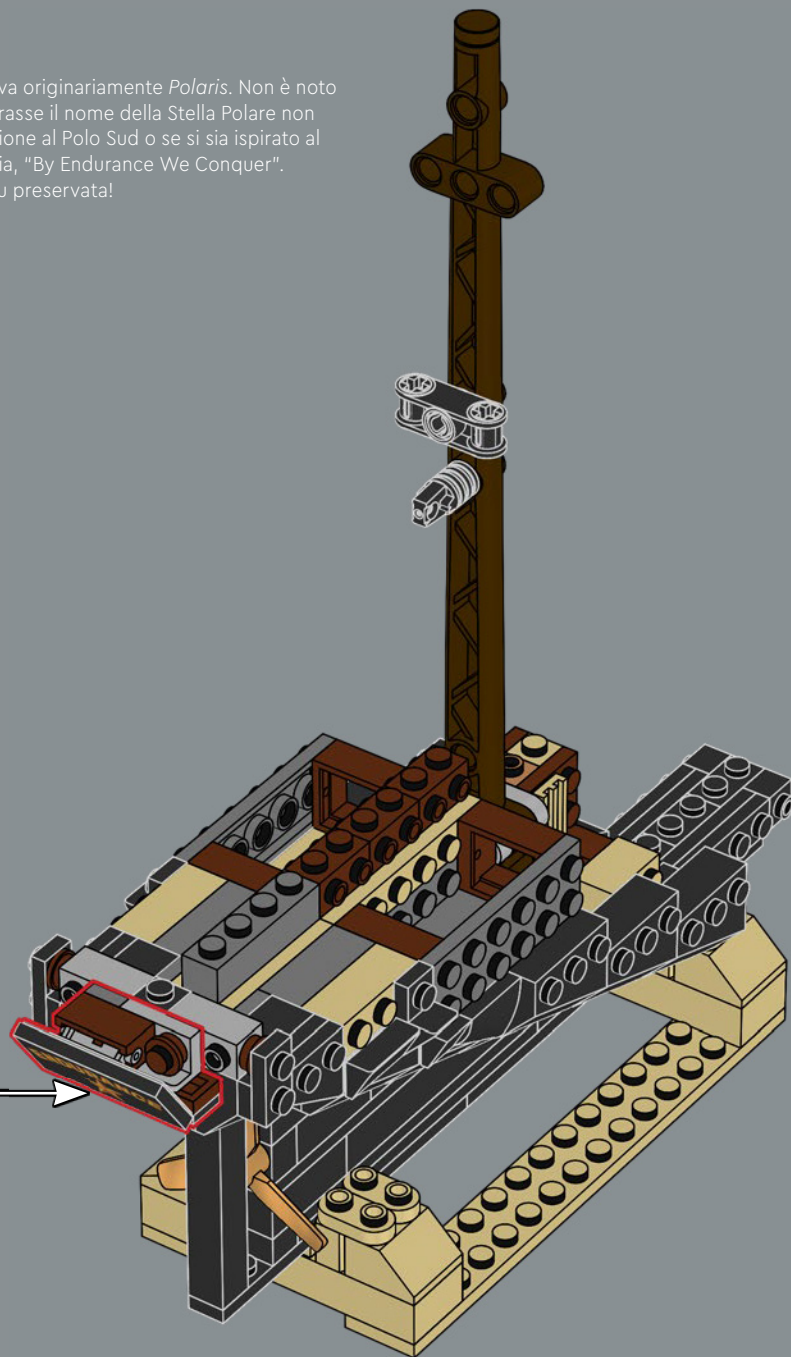

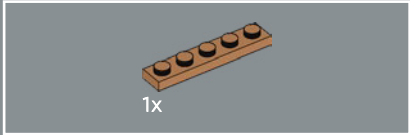
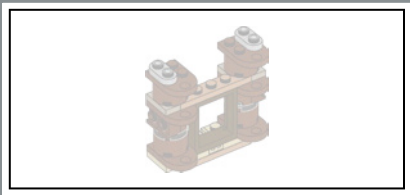

323

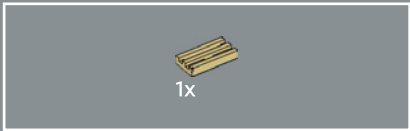
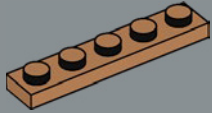

324

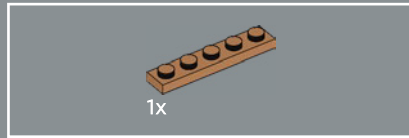
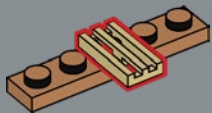

325

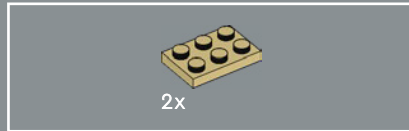
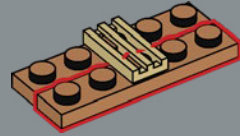

326

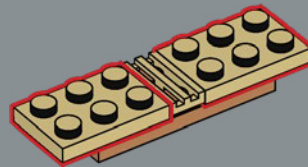

327

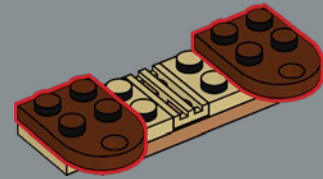

328

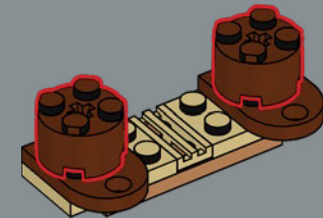



329

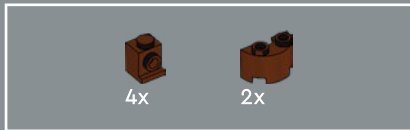
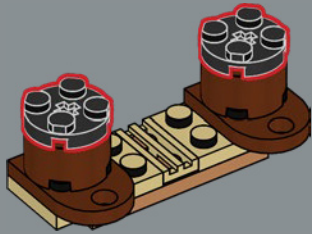

330

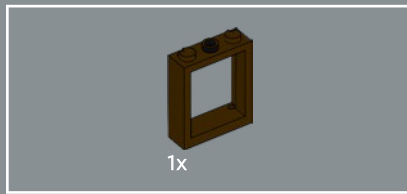
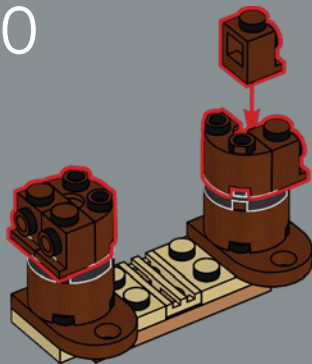

331

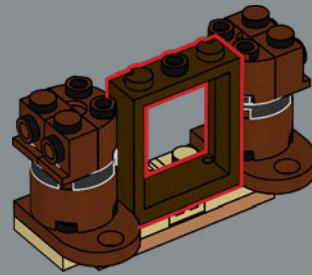

332

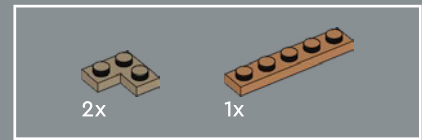
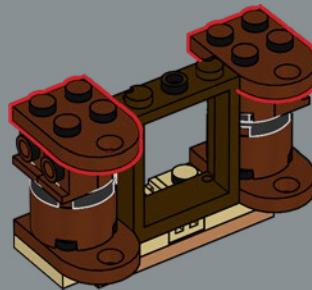

333

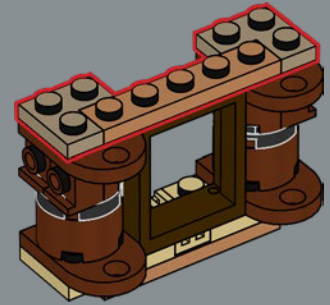

334

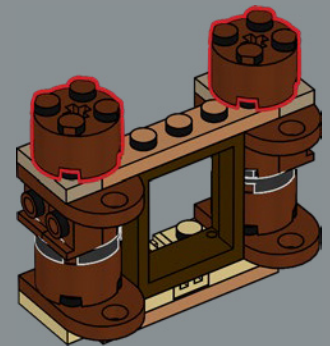



335

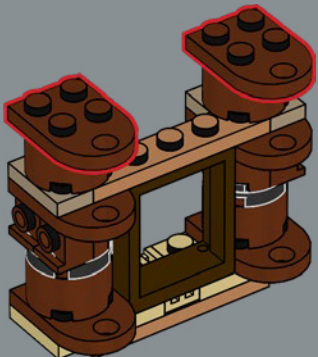

336

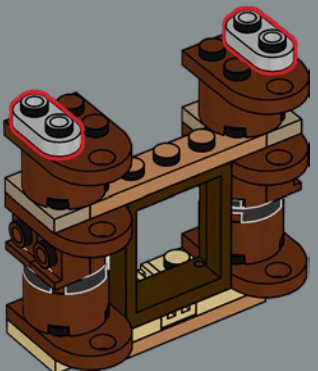

337

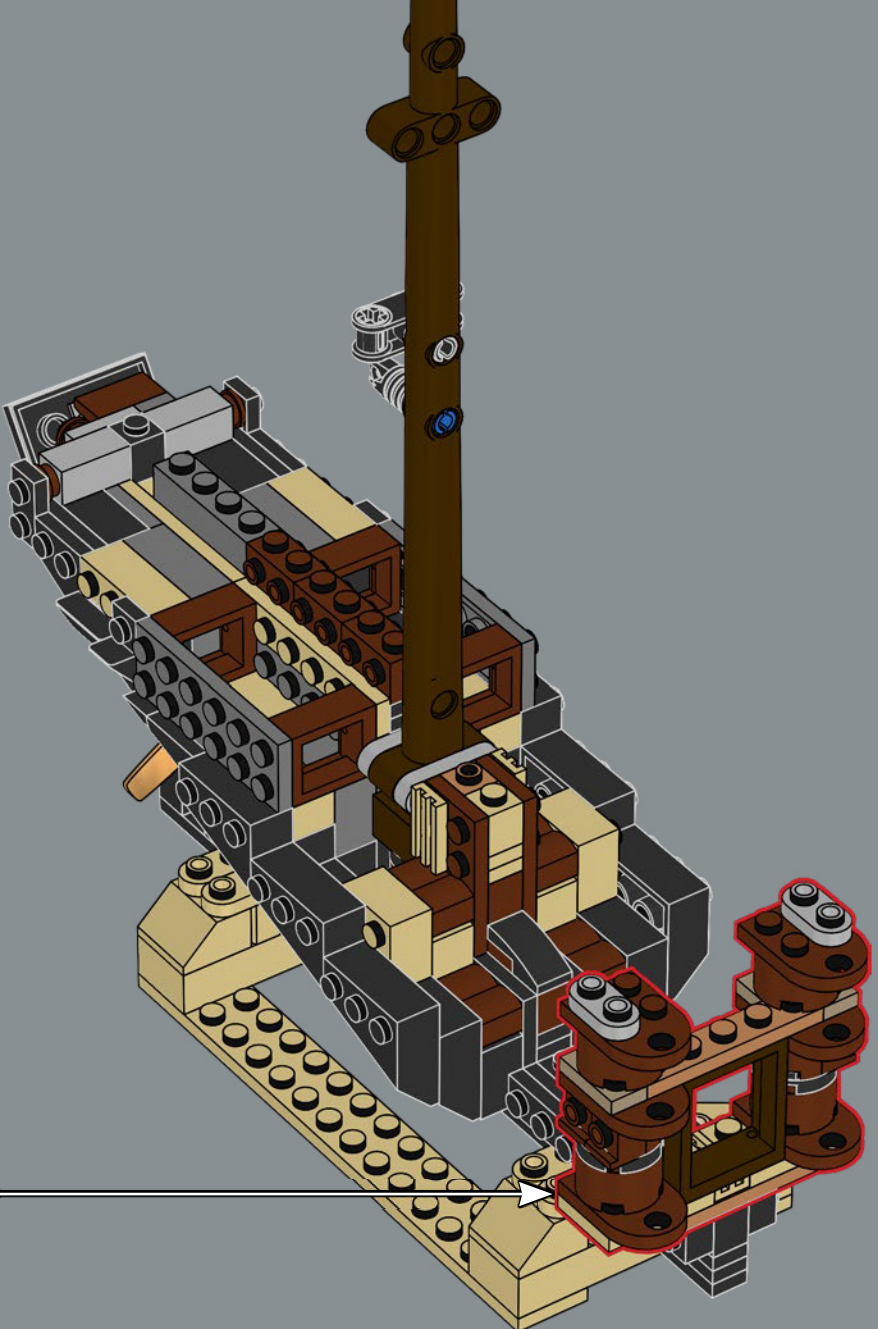

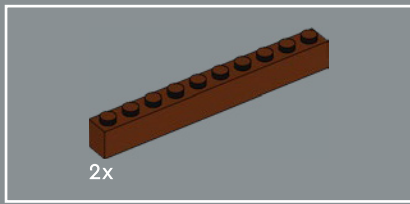

338

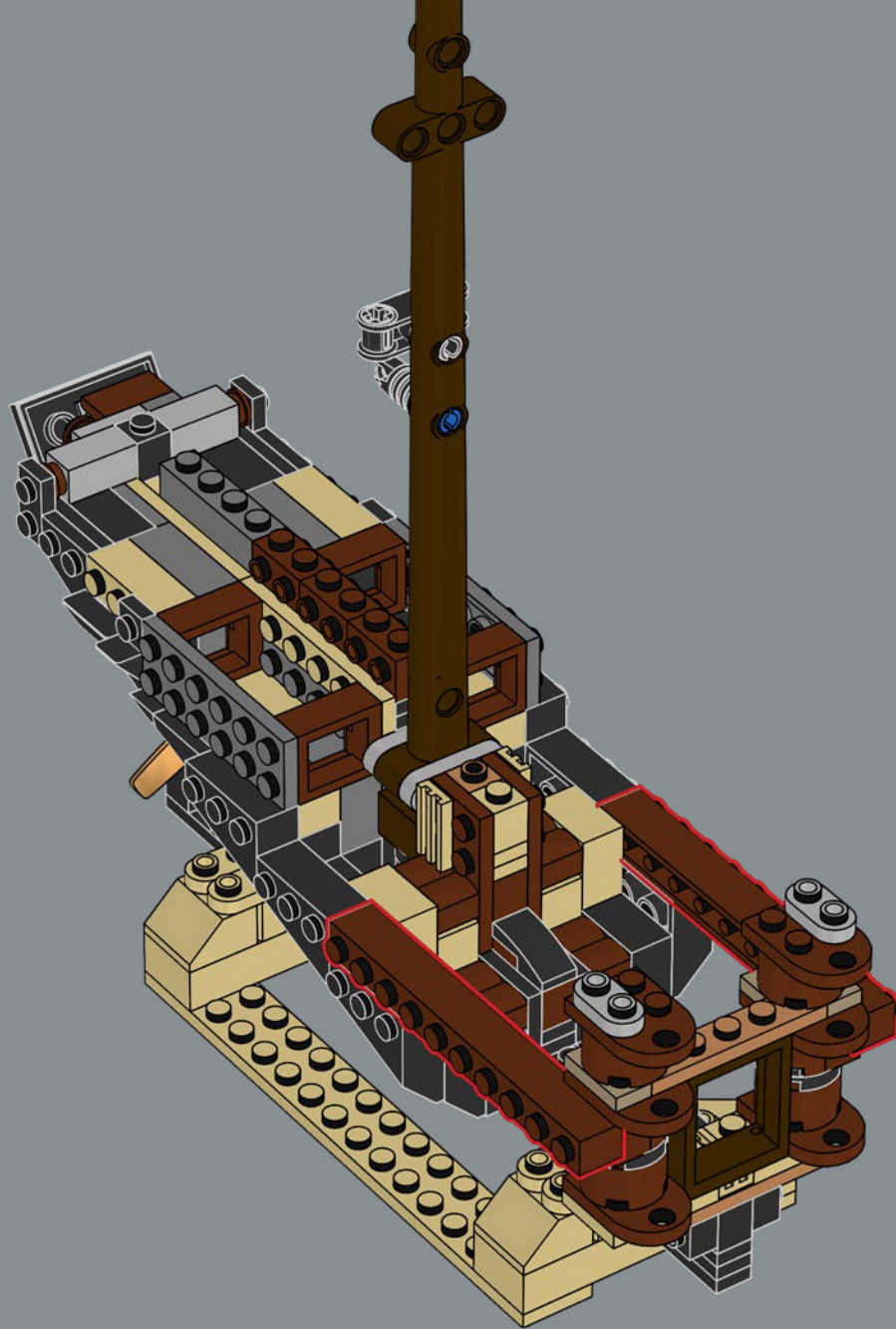

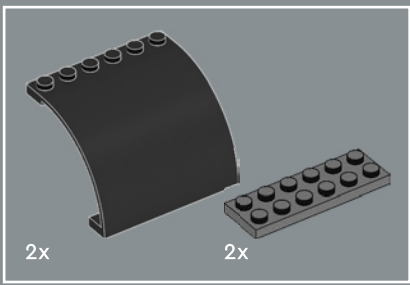

339

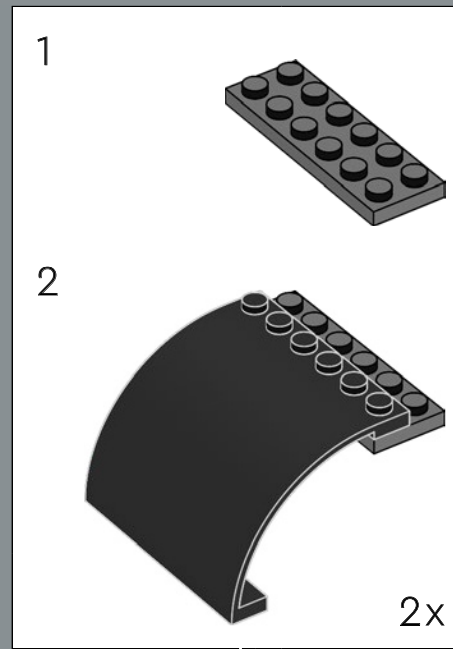
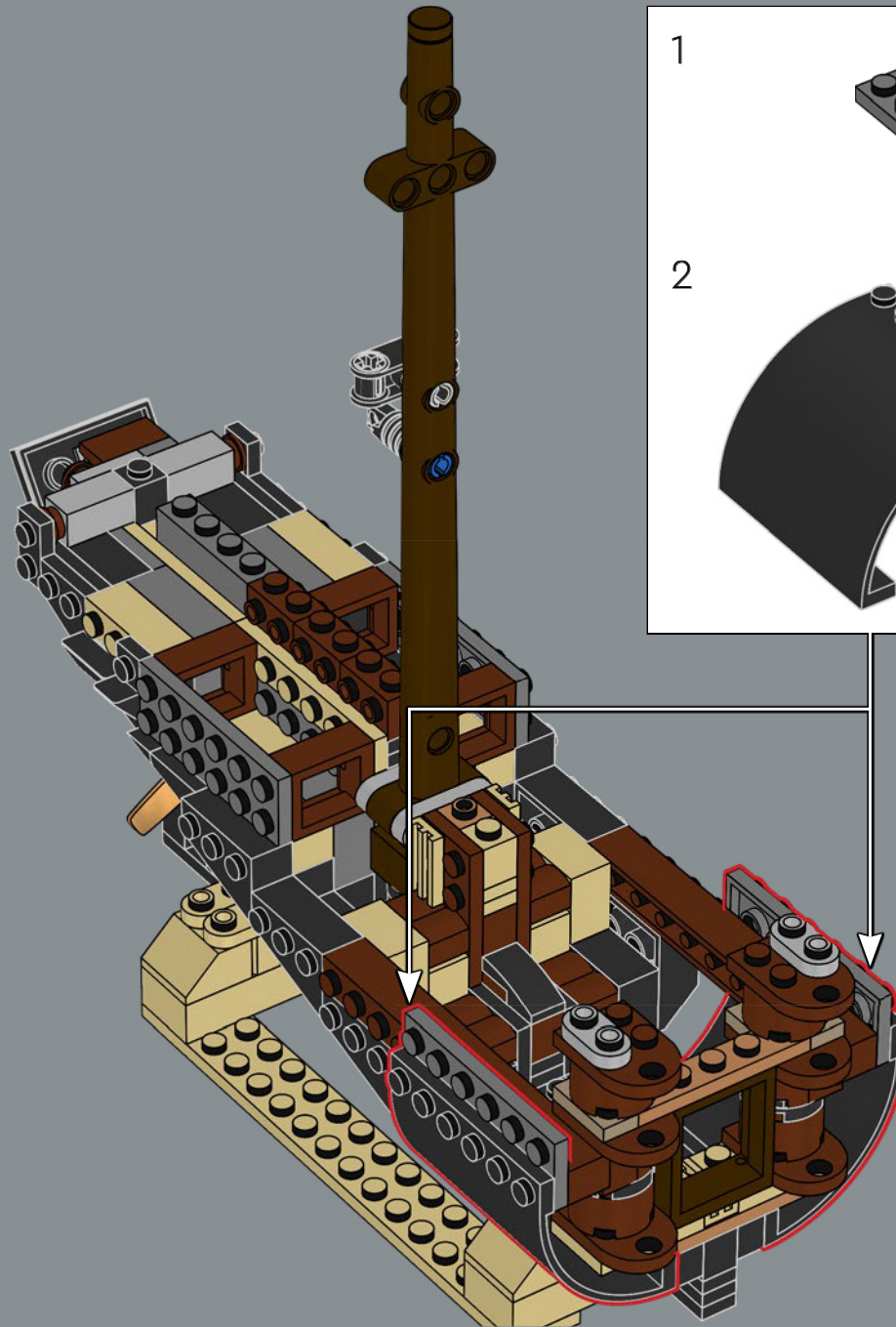

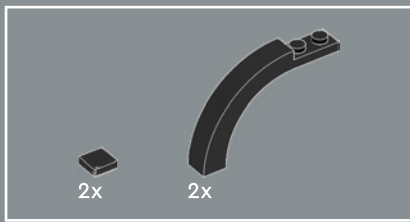

340

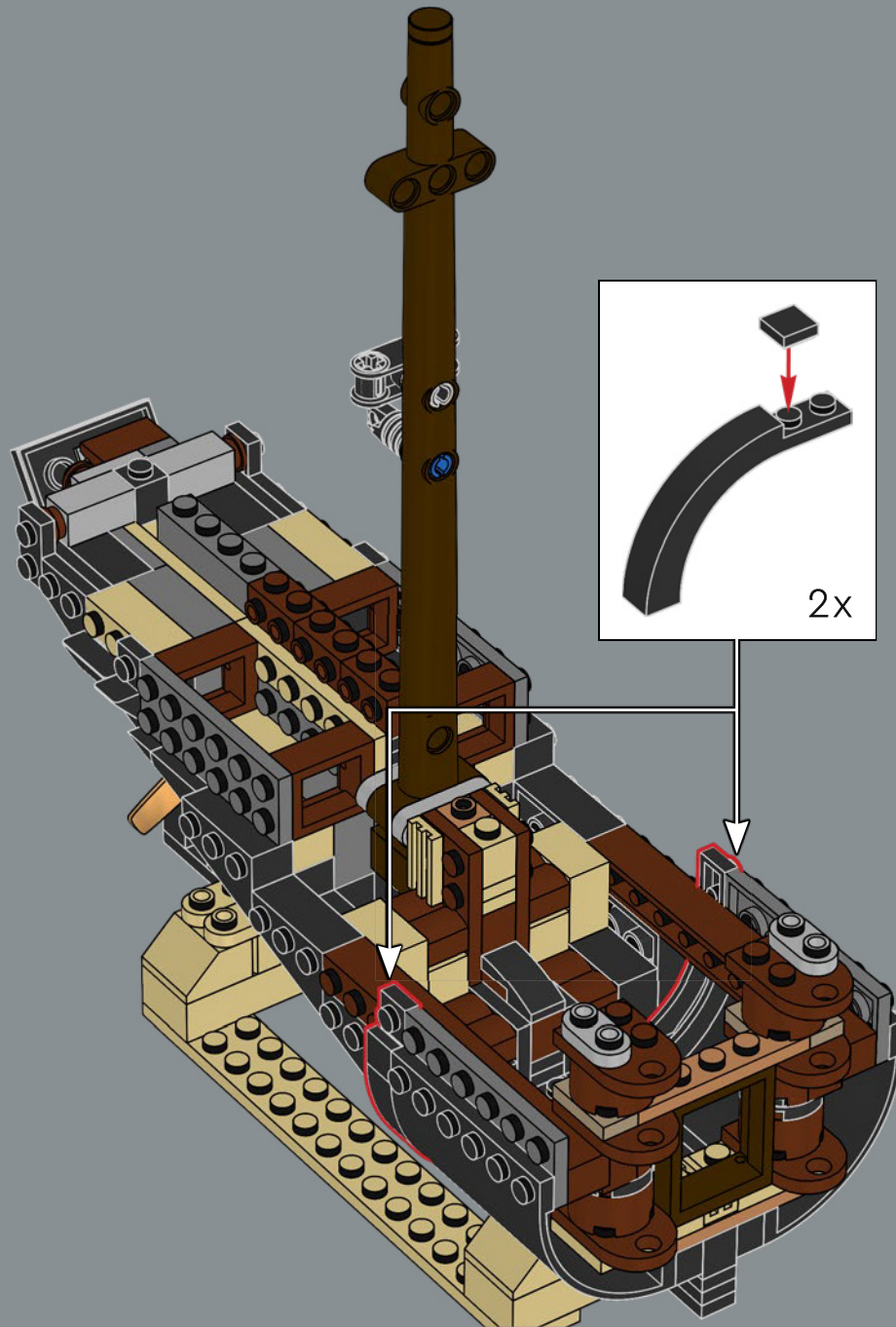

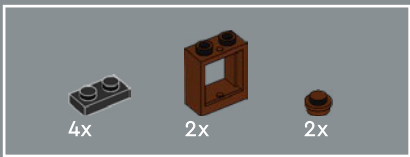

341

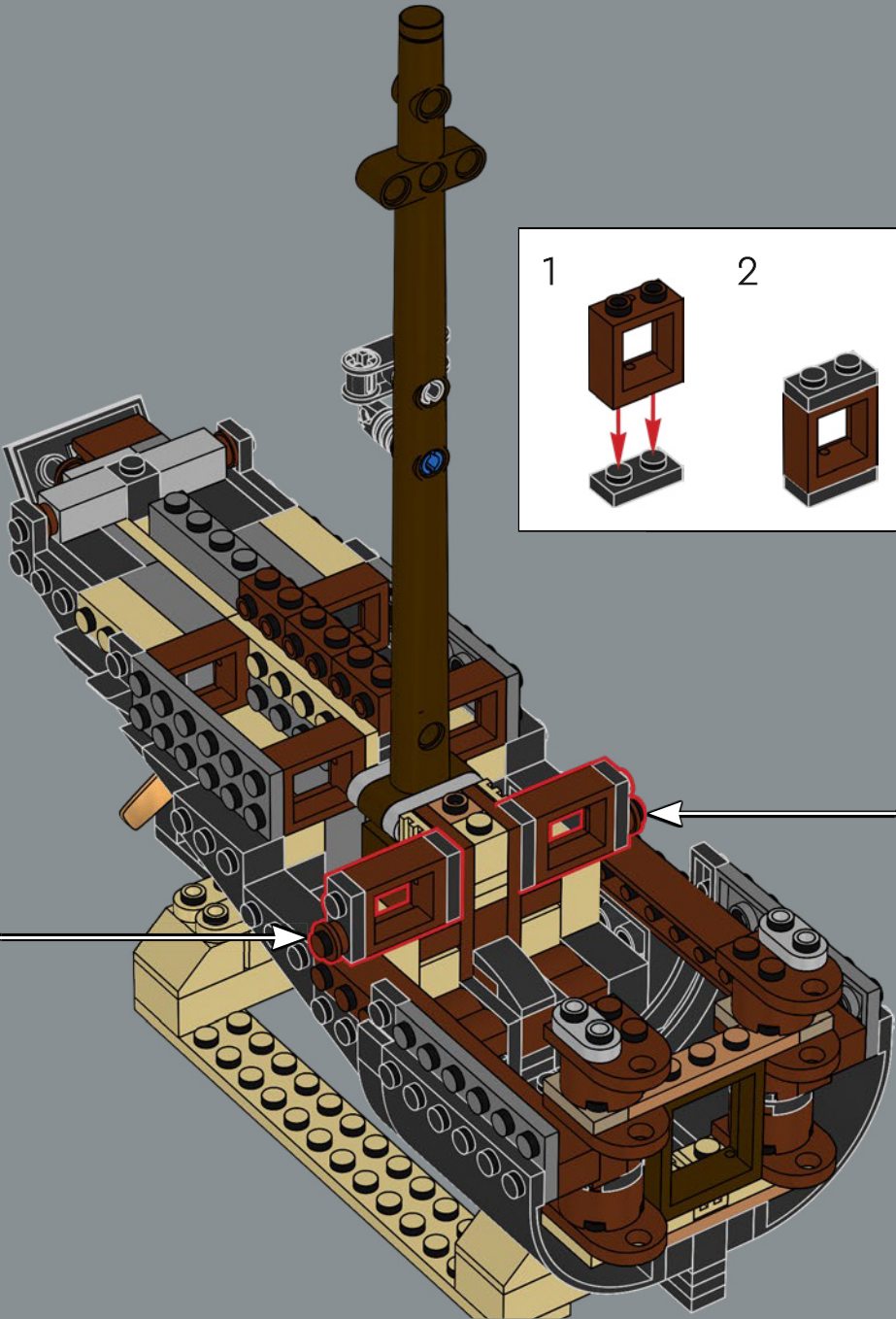
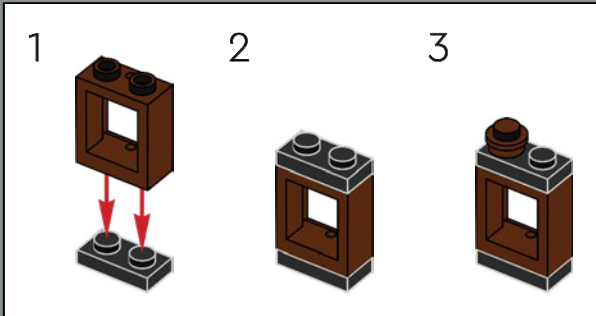
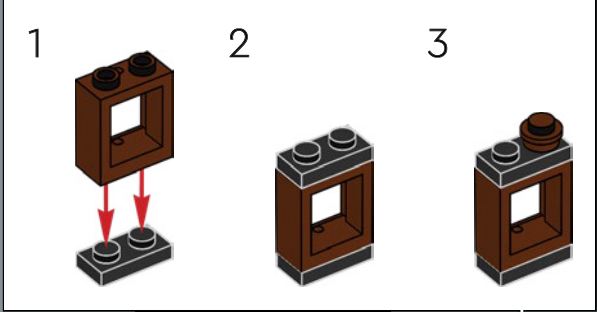

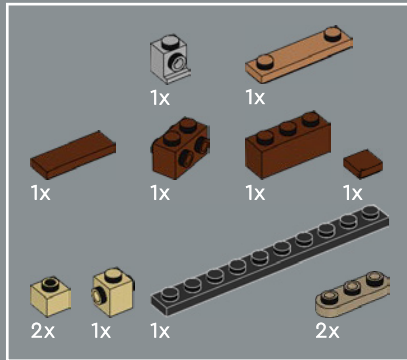
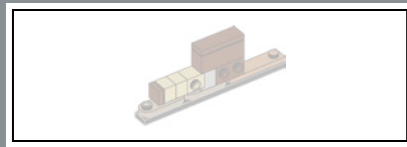

342

1

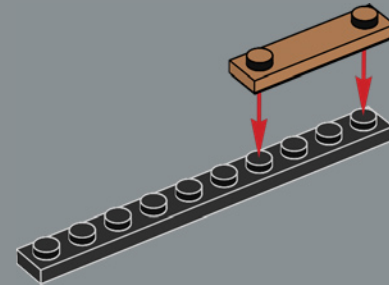

2

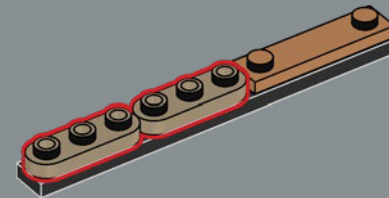

3

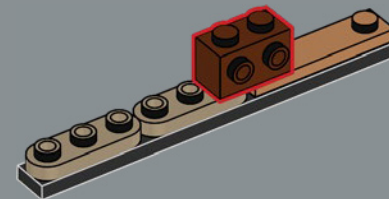

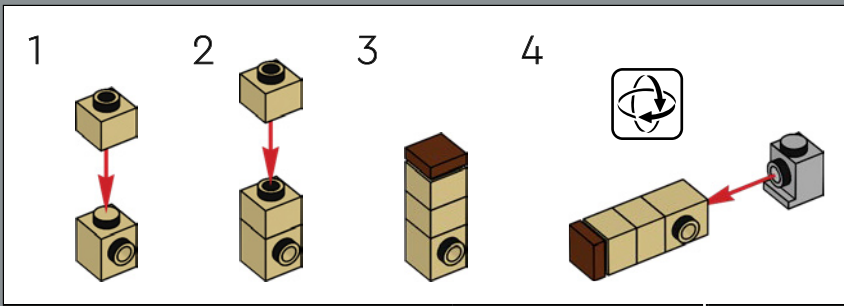

4

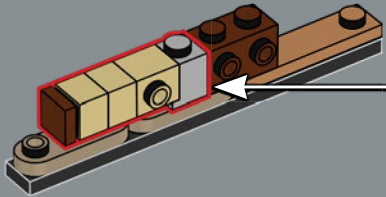

5

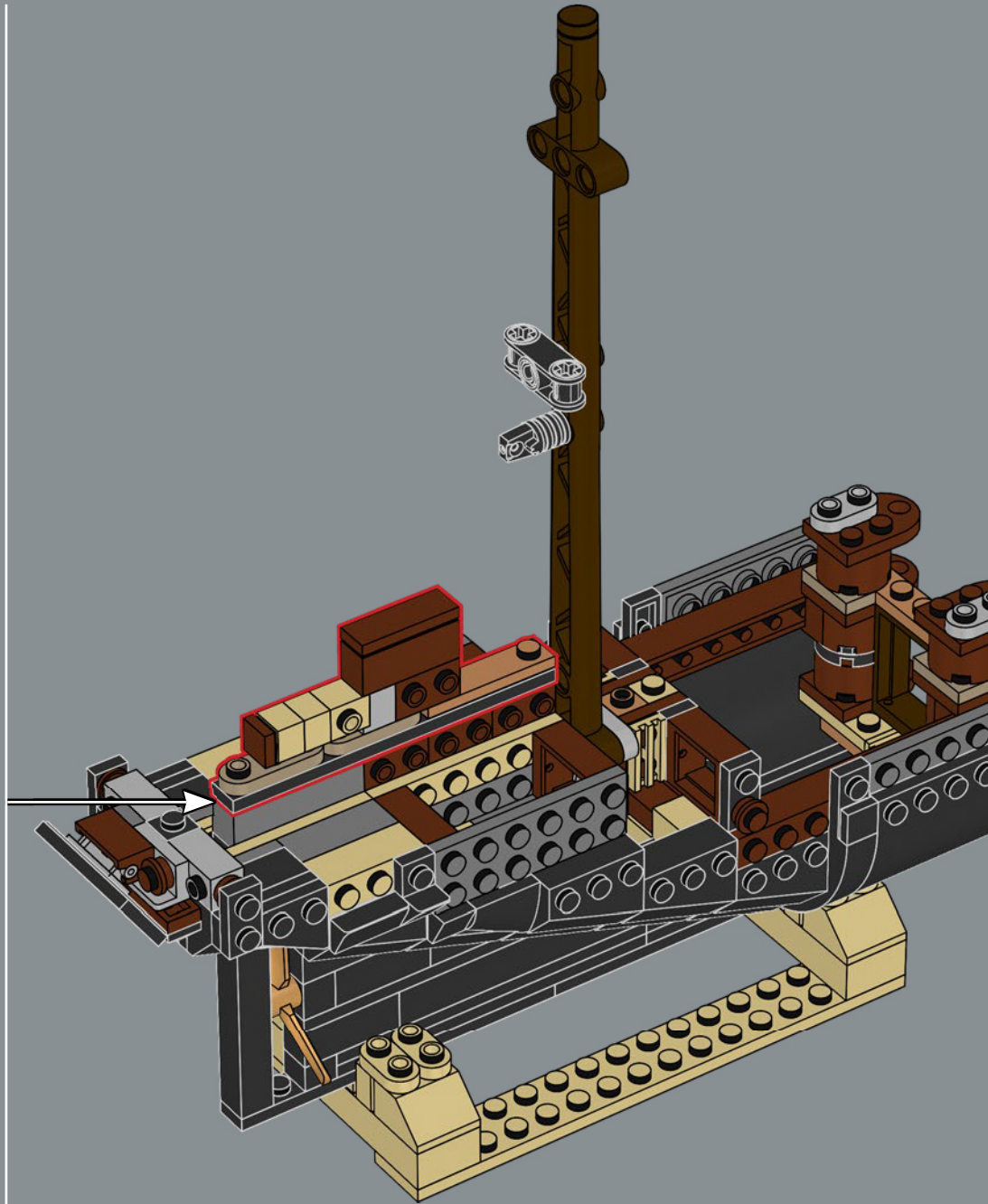
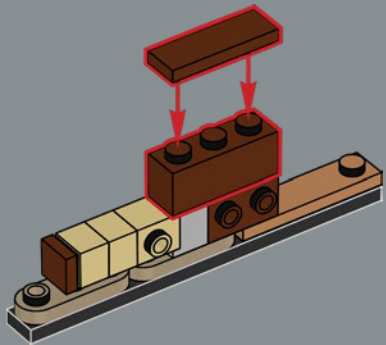

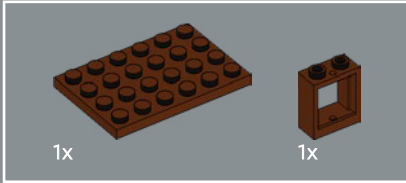
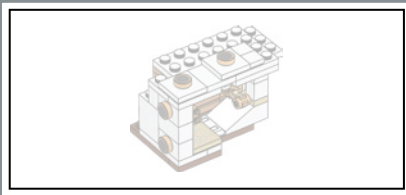

343

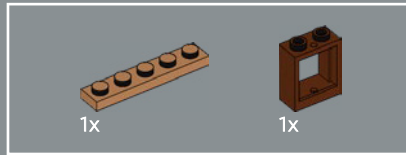
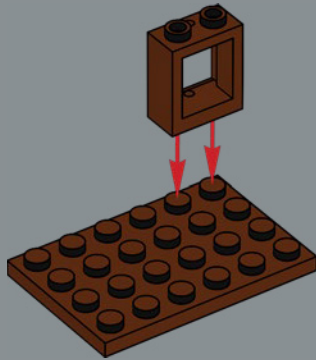

344

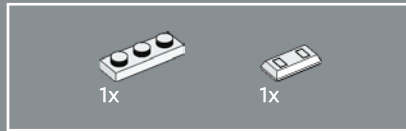
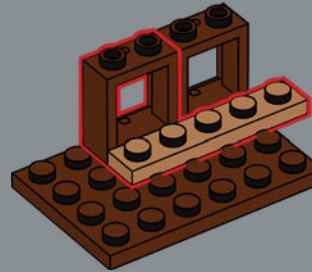

345

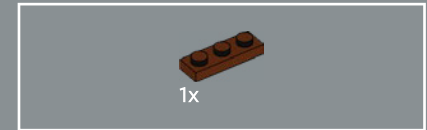
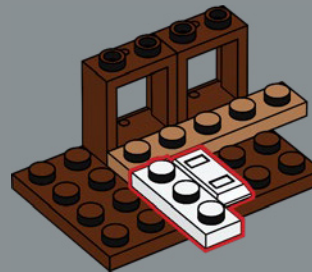

346

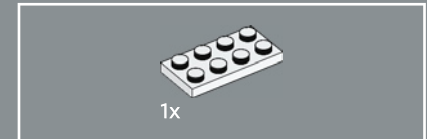
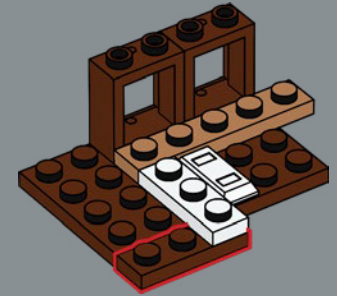

347

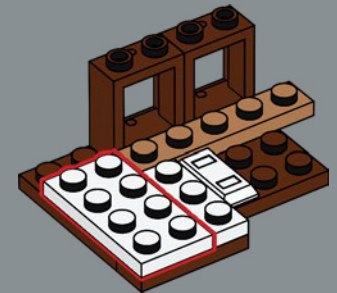

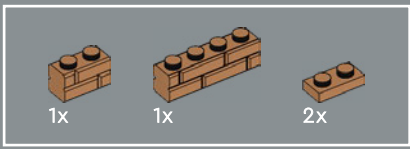

348

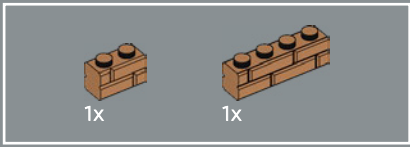
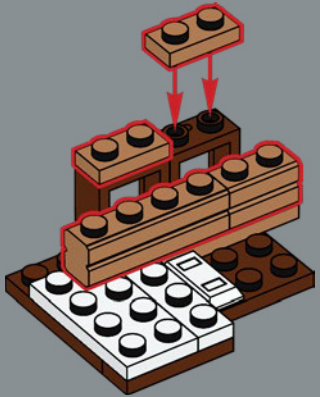

349

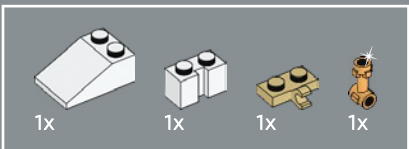
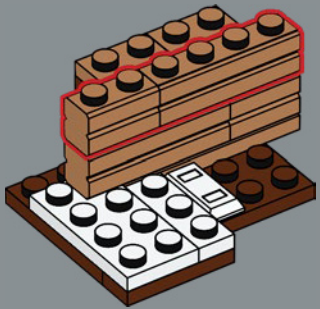

350

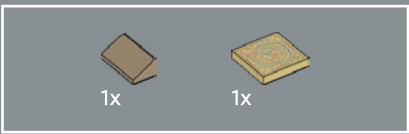
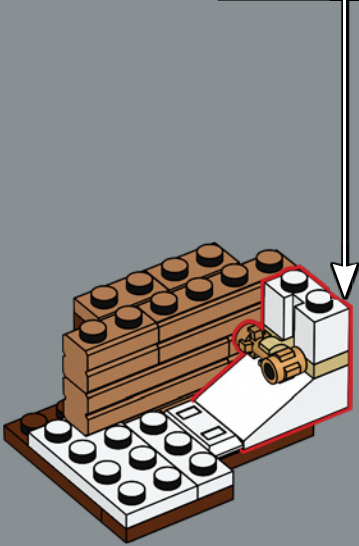
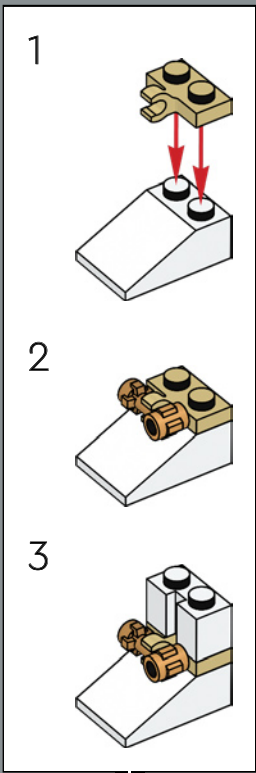

351

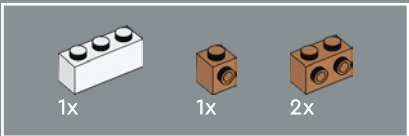
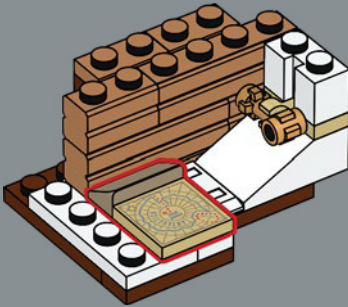

352

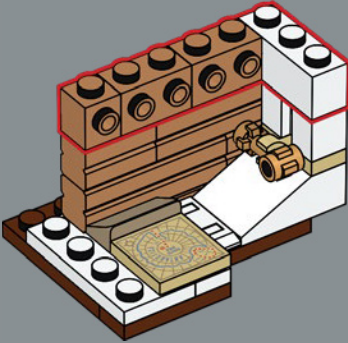

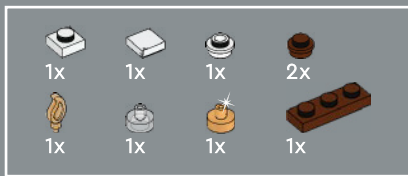

353

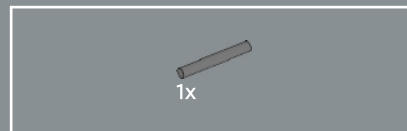
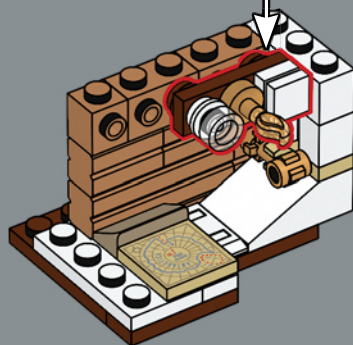
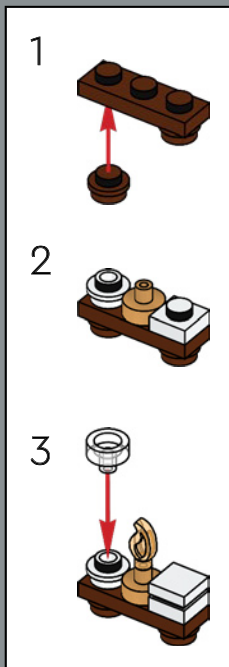

354

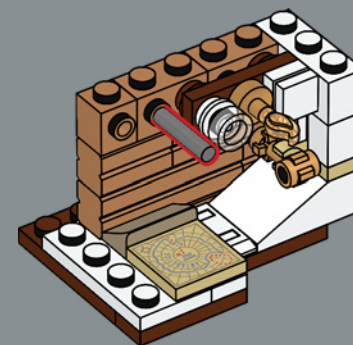

I bastoncini verticali grigio scuro all'interno delle cabine sono tubi di riscaldamento a vapore. La cabina dello scienziato contiene un'esclusiva mappa LEGO® dell'Antartide.

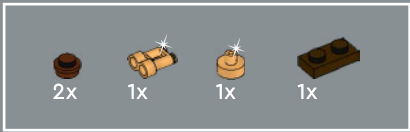

355

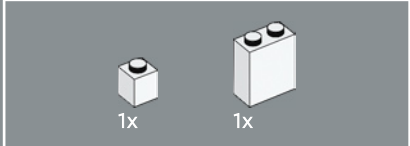
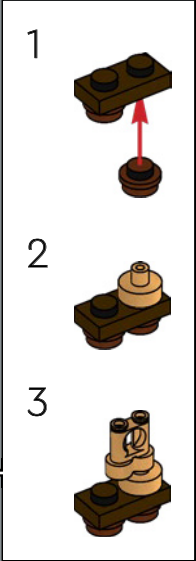
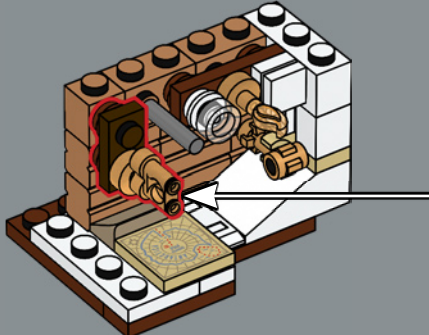

356

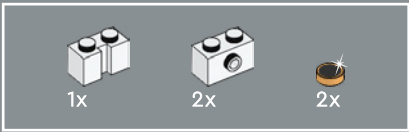
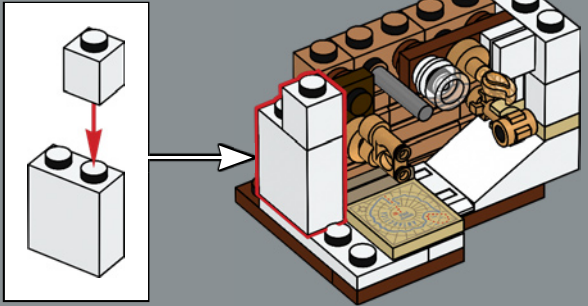

357

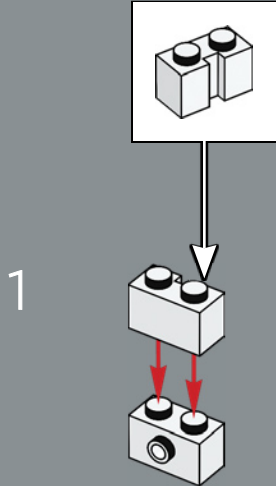

2

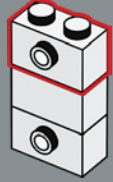

3

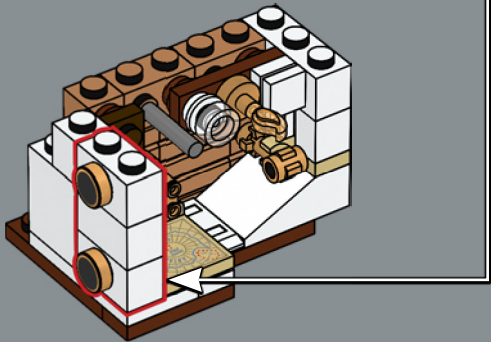
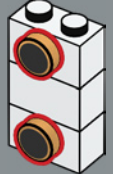

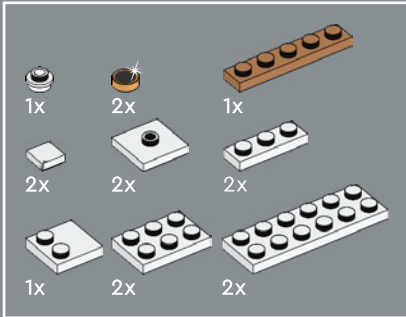
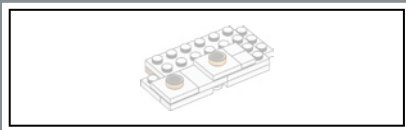

358

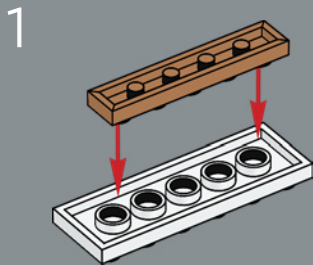

2

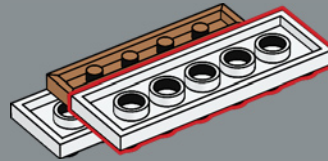

3

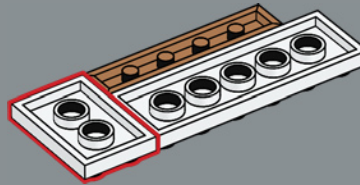

4

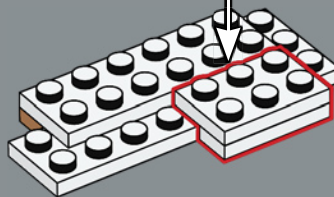
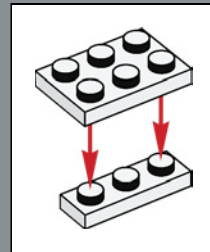

5

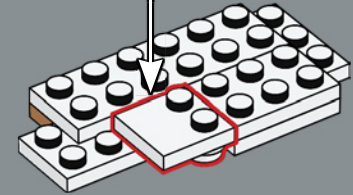
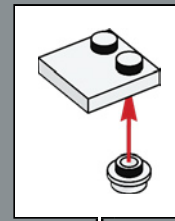

6

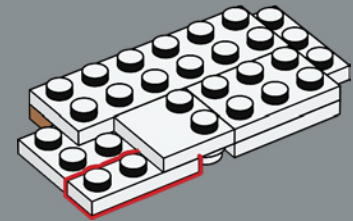

7

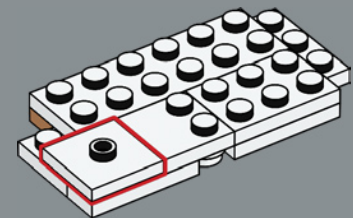

8

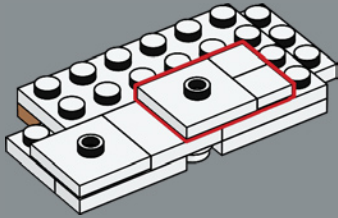

9

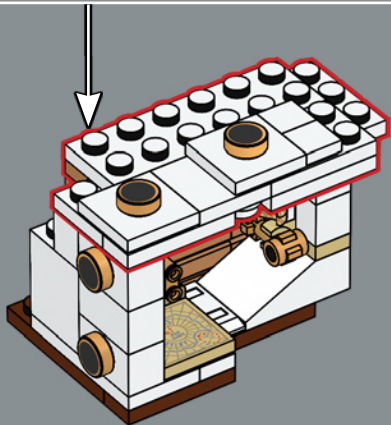
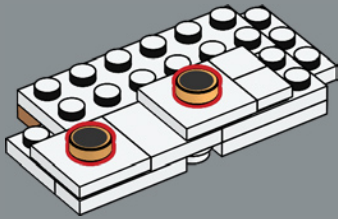

359

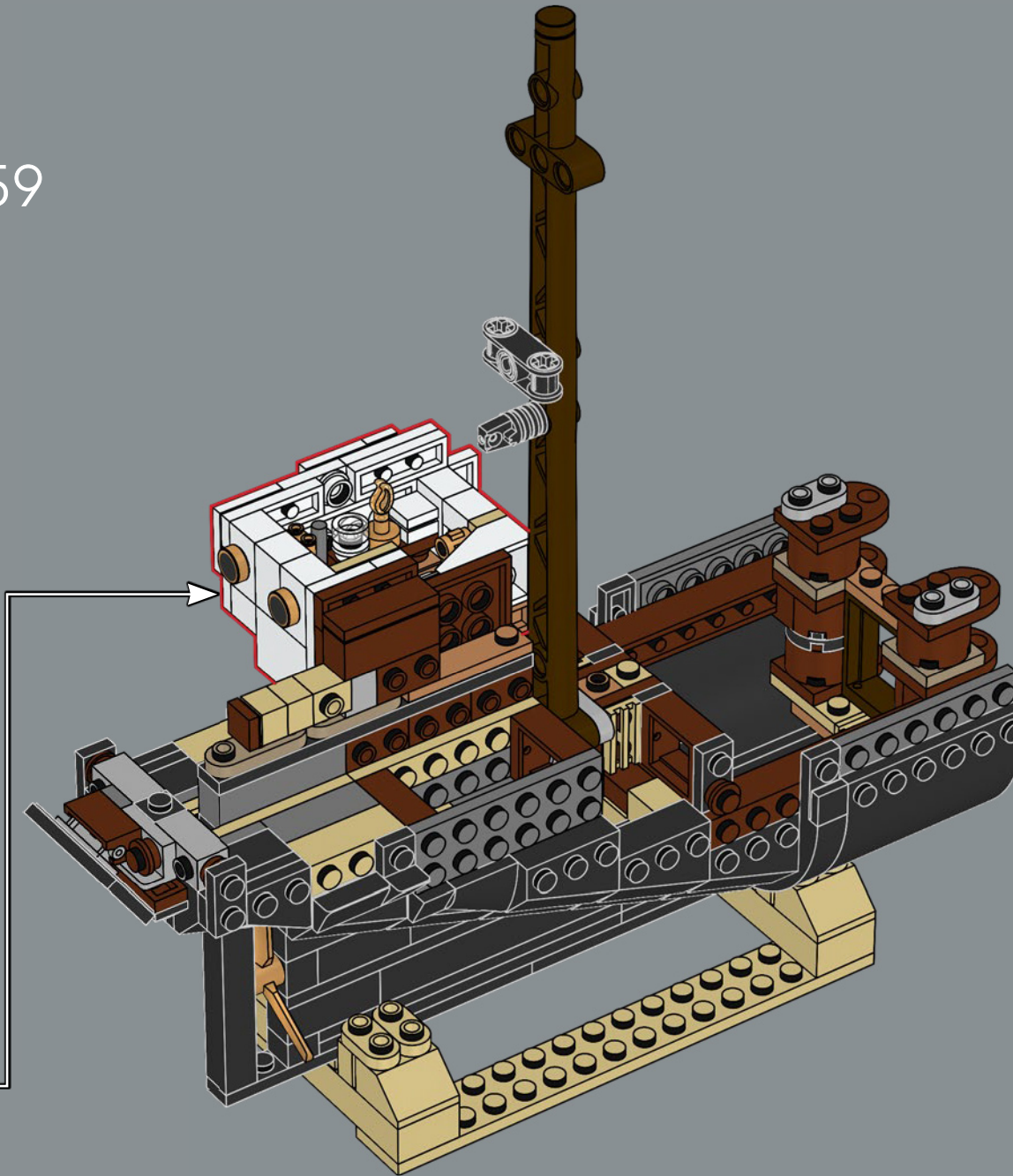

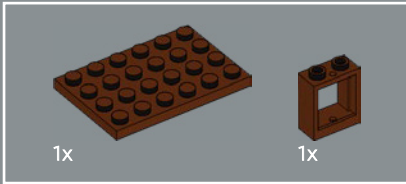
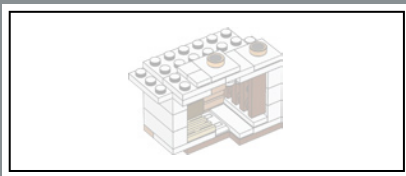

360

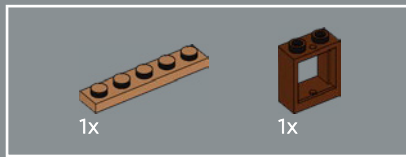
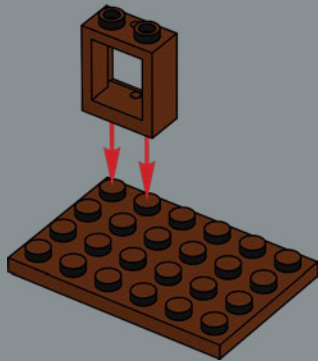

361

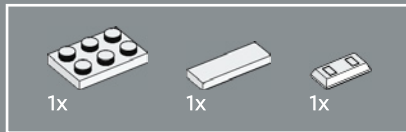
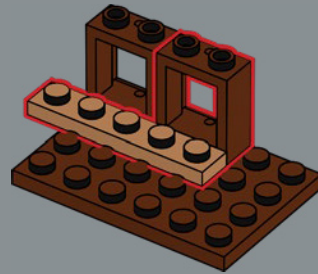

362

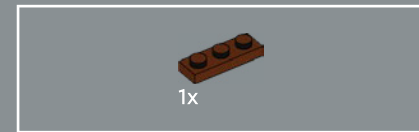
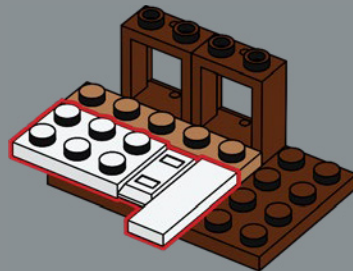

363

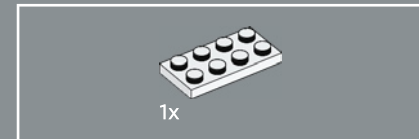
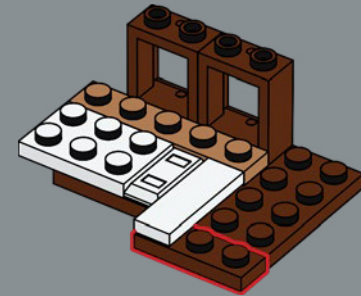

364



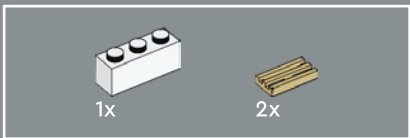

365

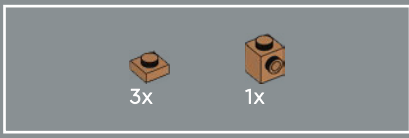

367

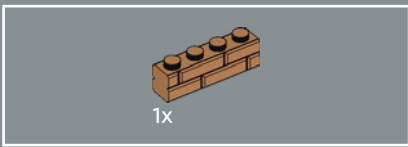
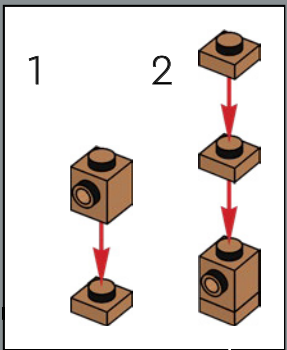
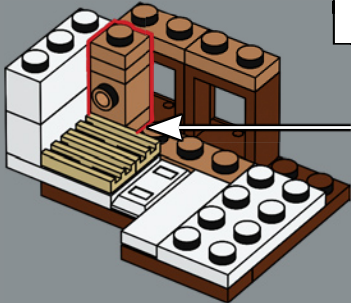

369

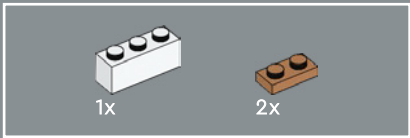
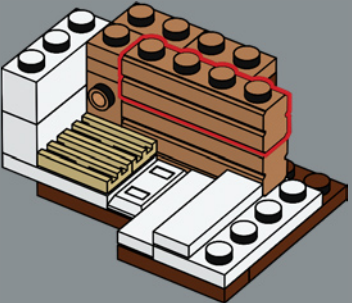

366

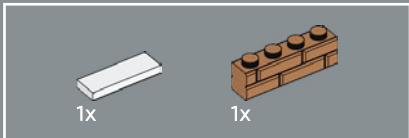
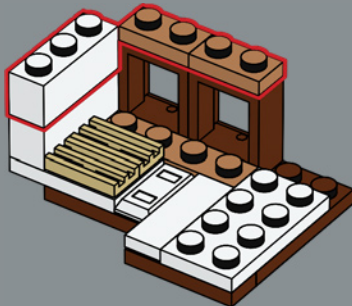

368

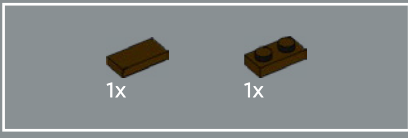
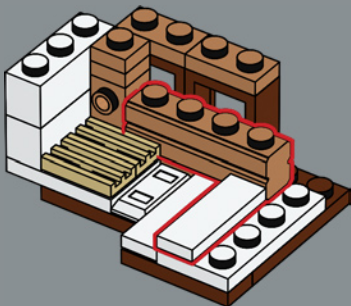

370

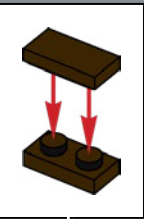
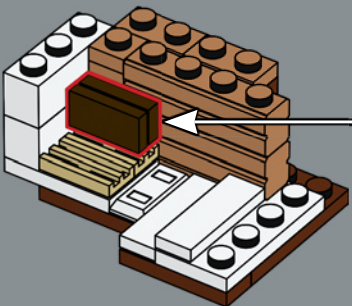

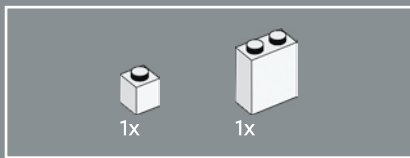

371

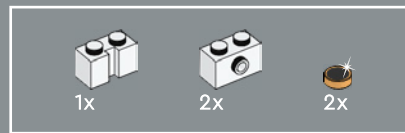
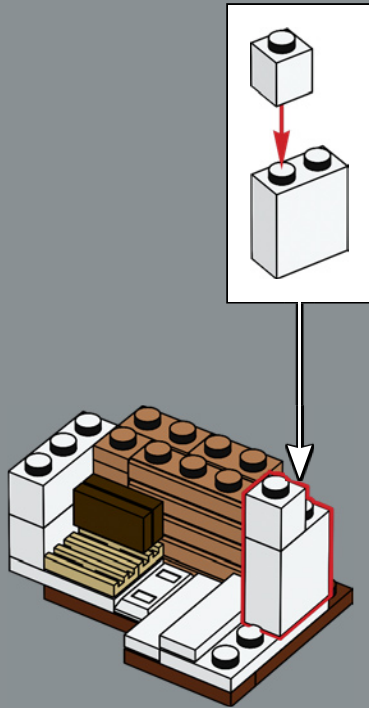

372

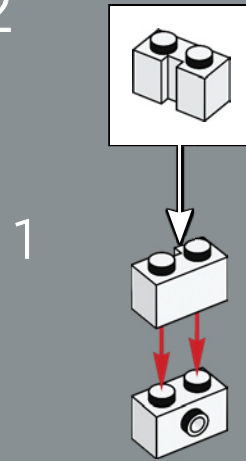

1

2

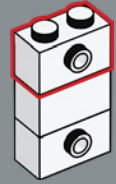

3

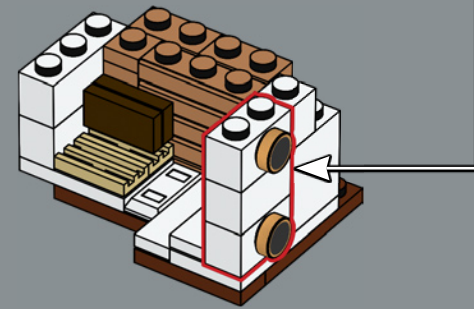
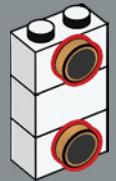

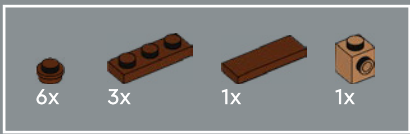

373

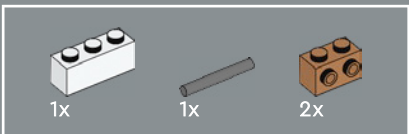
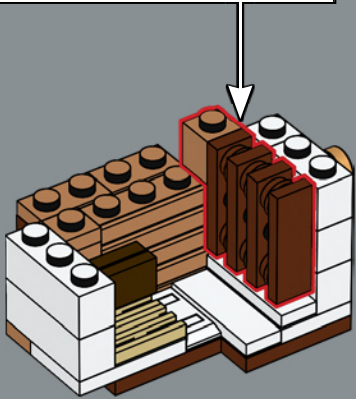
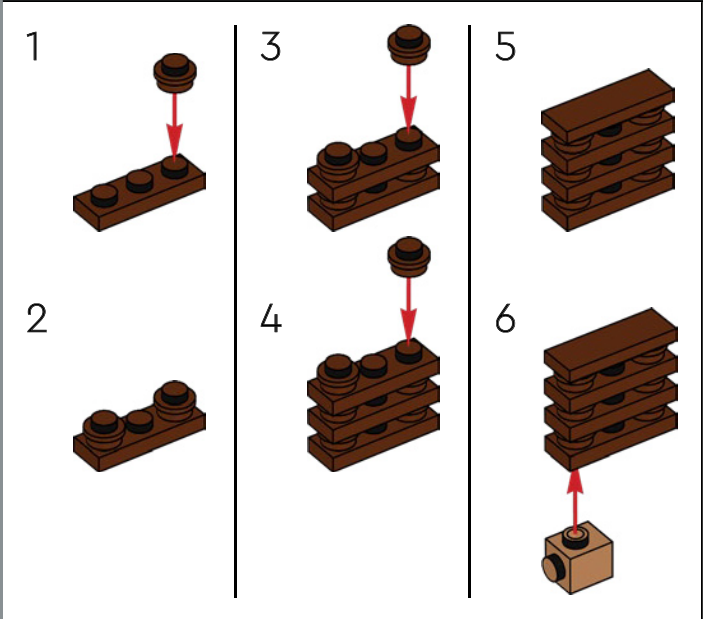

374

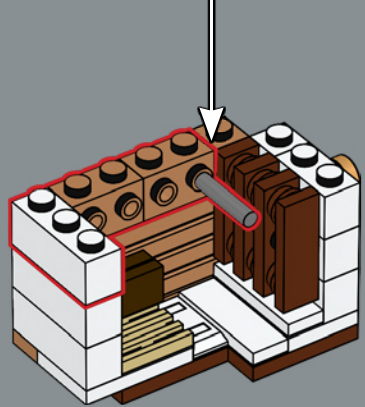
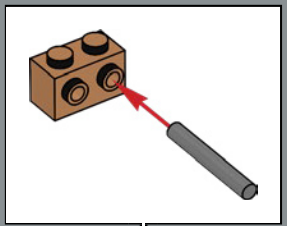

375

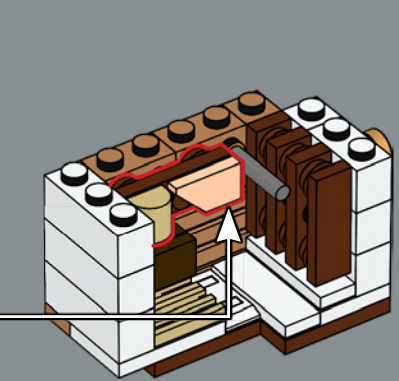
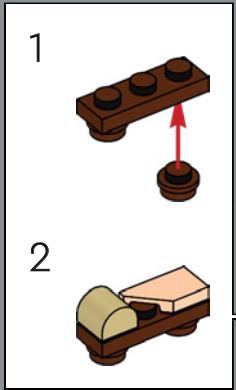

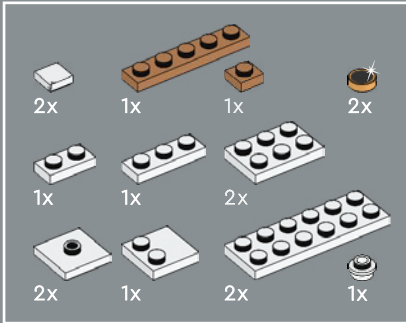
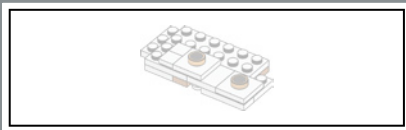

376

1

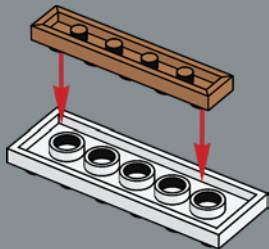

2

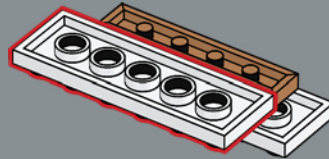

3

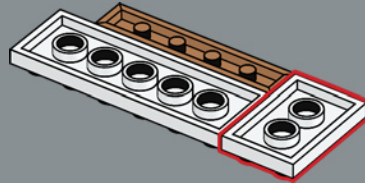

4

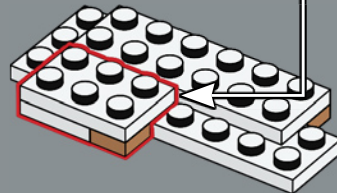
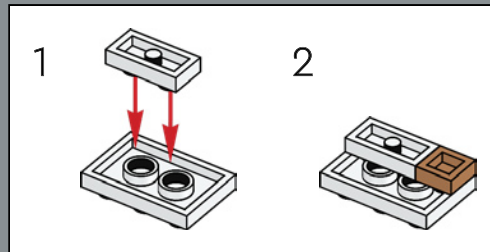

5

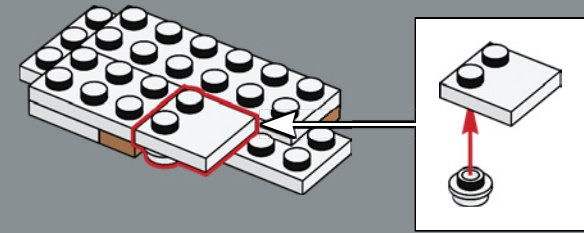

6

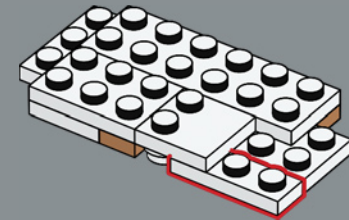

7

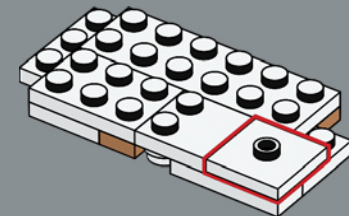

8

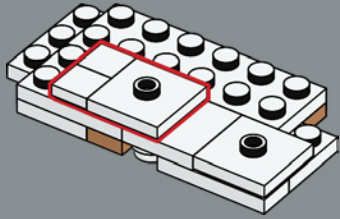

9

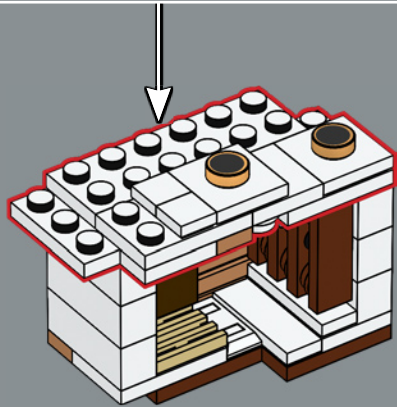
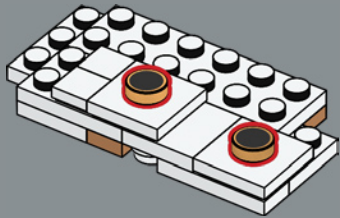

377

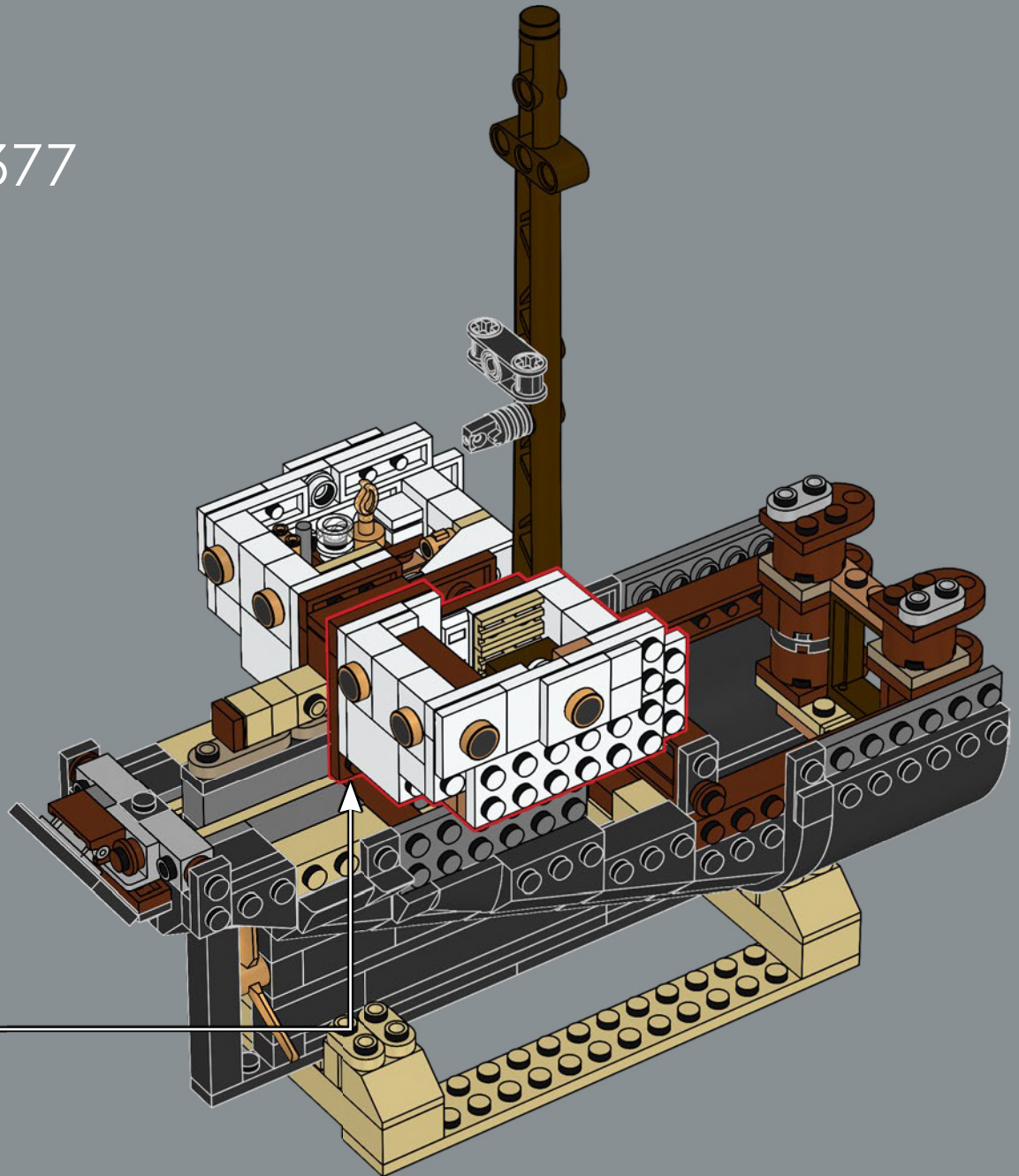

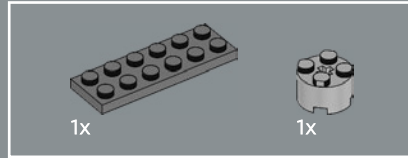
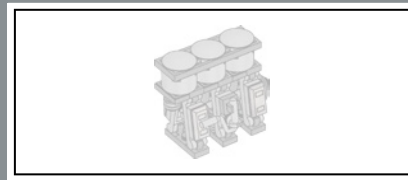

378

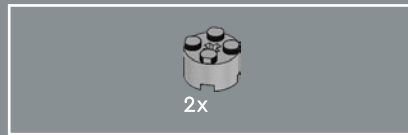
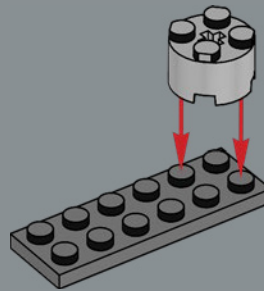

379

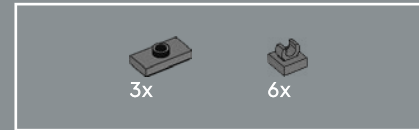
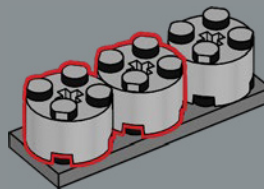

380

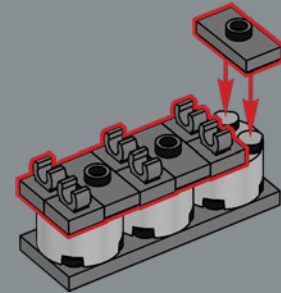

381

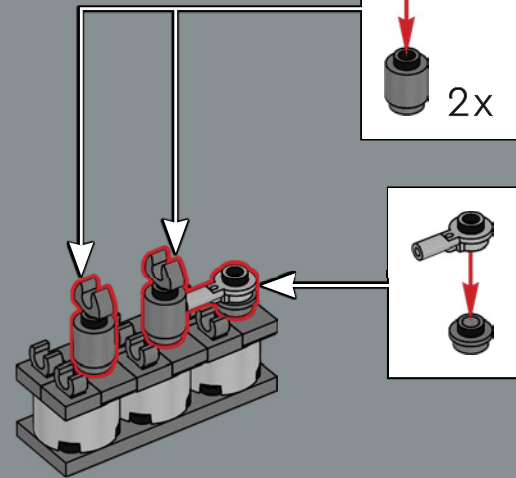

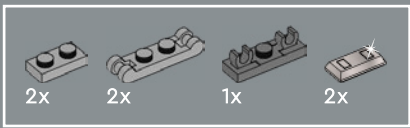

382

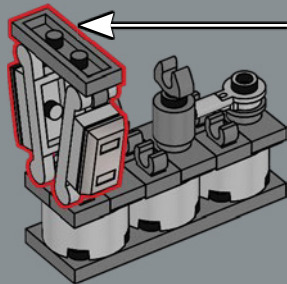
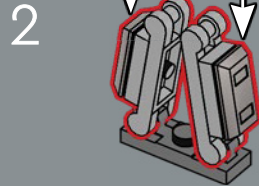
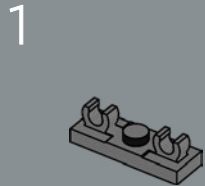
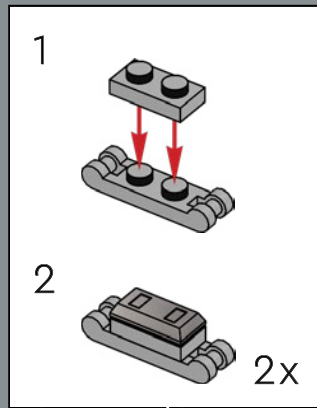

383

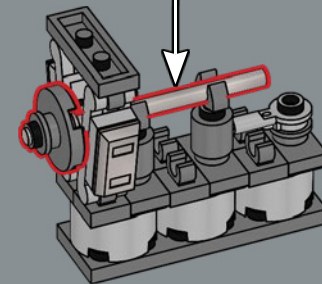
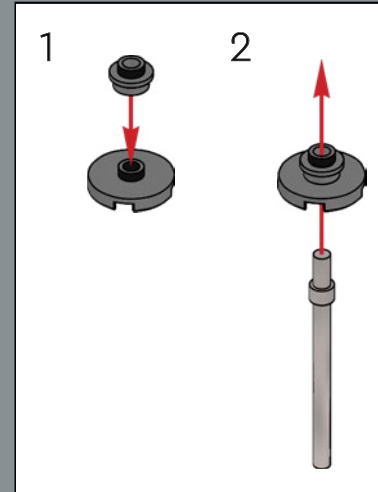

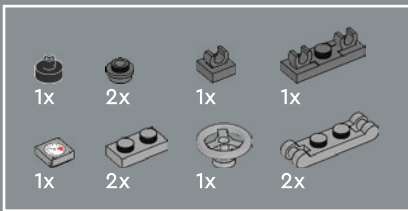

384

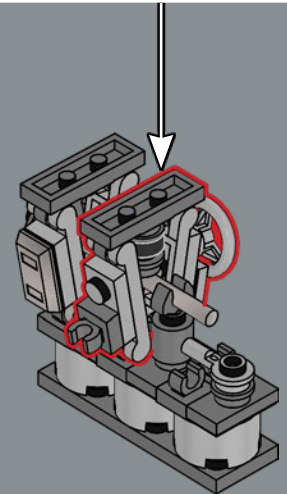
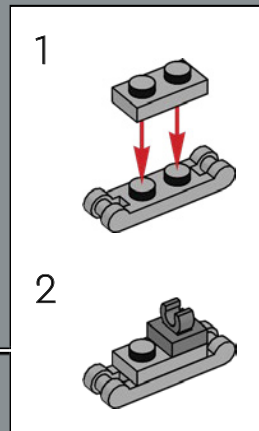
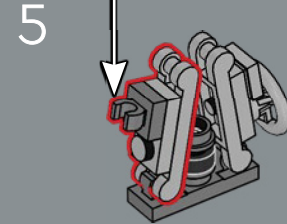
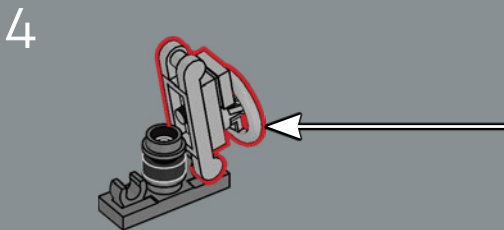
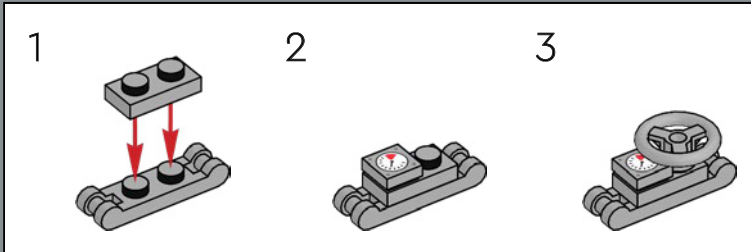
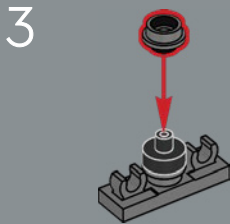
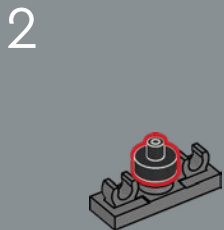
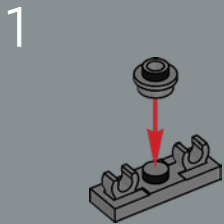

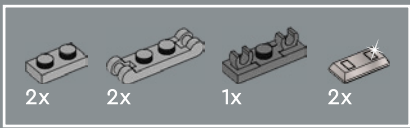

385

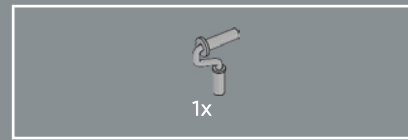
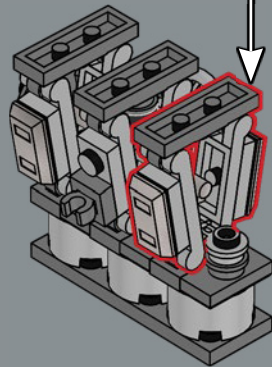
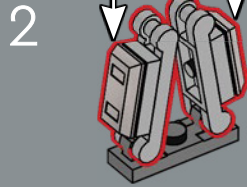
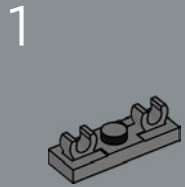
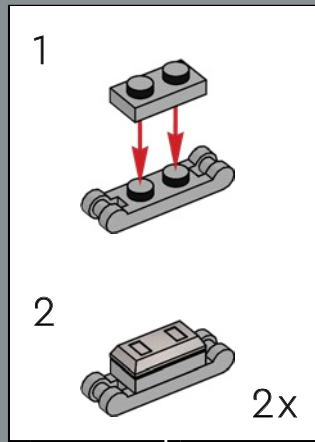

386

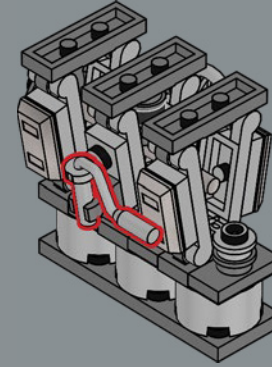

387

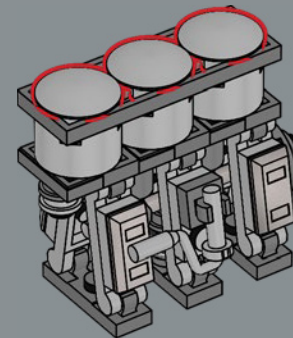



Il "motore a vapore a tripla espansione" può essere
rimosso dalla sala macchine ed esposto.

388

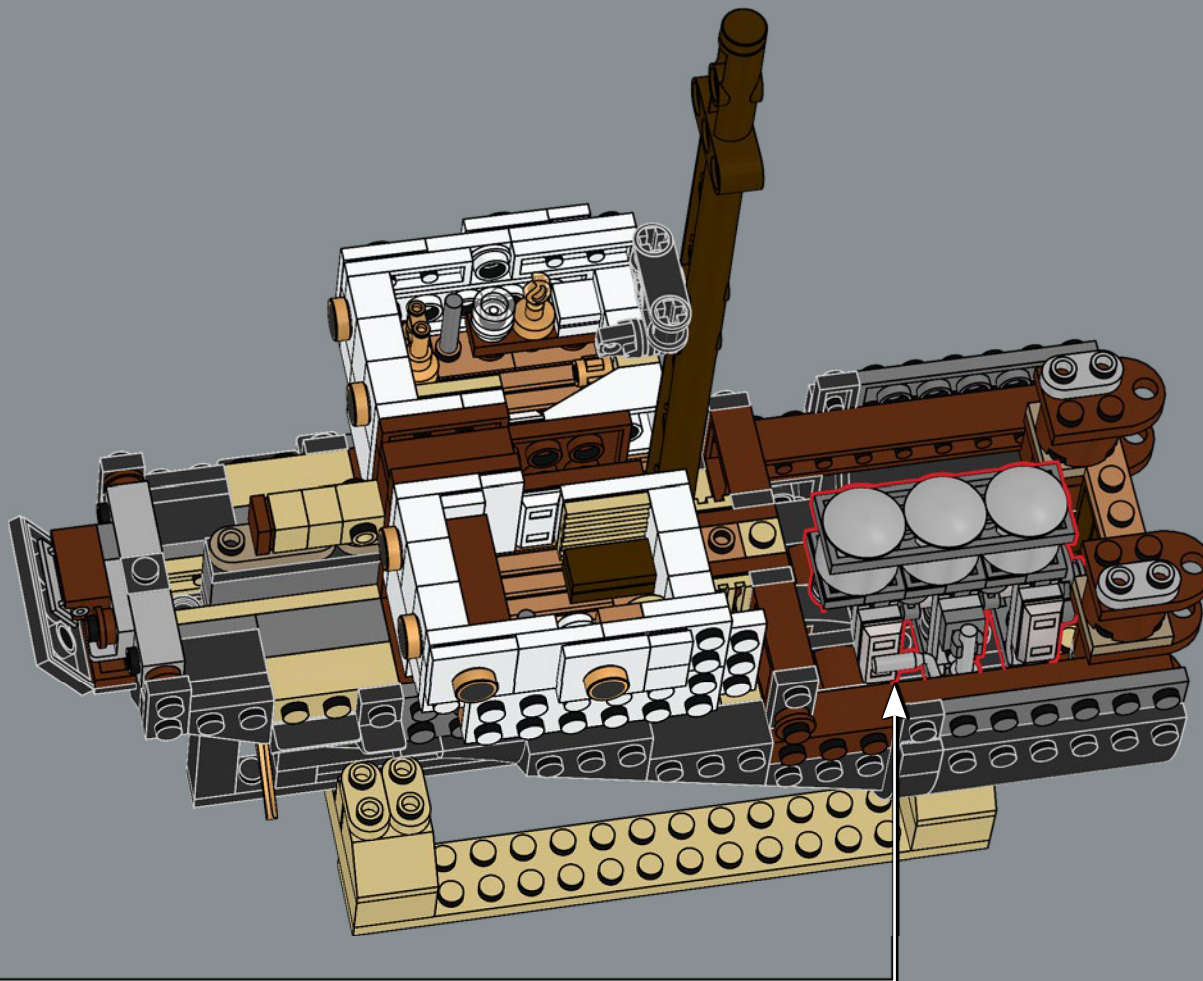

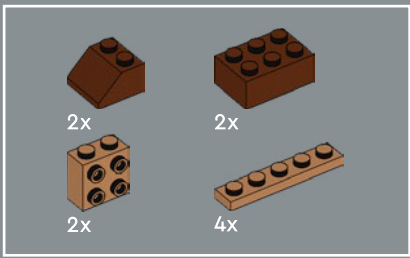

389

1



2

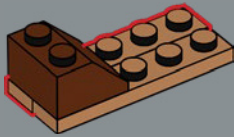

3

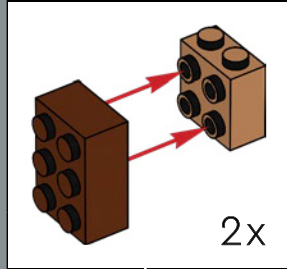
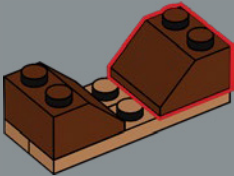

4

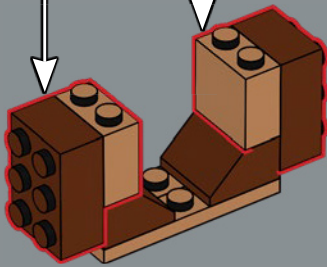

5

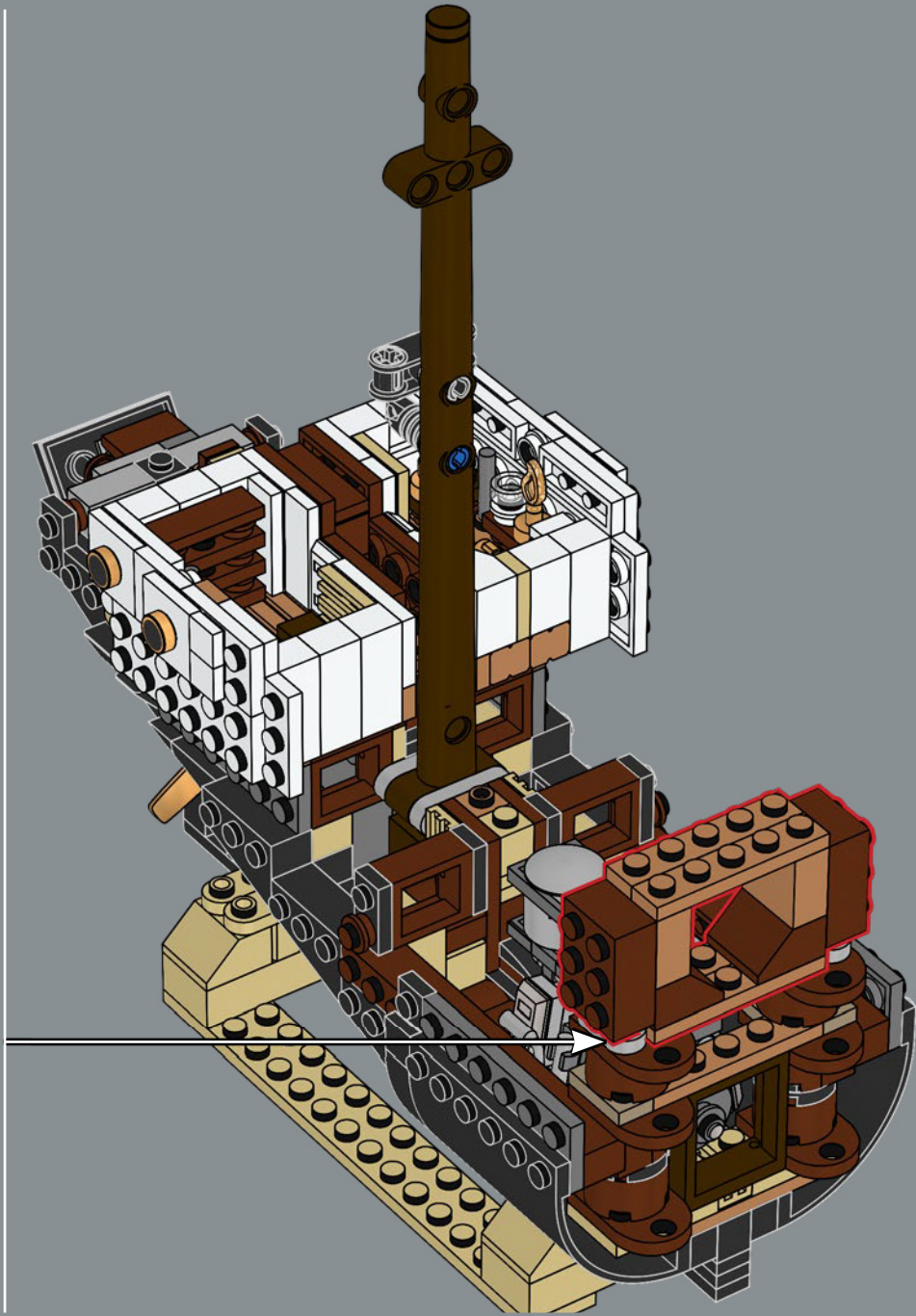
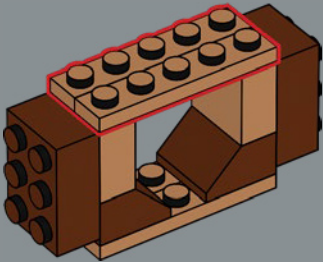

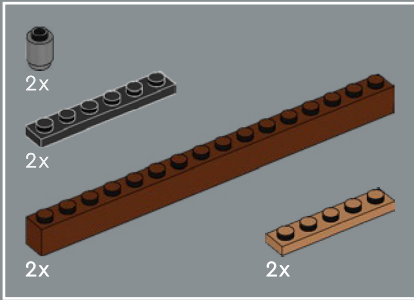
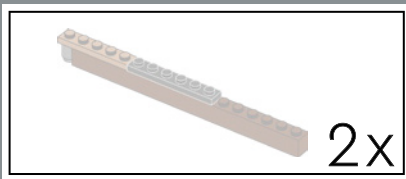

390

1

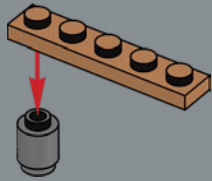

2

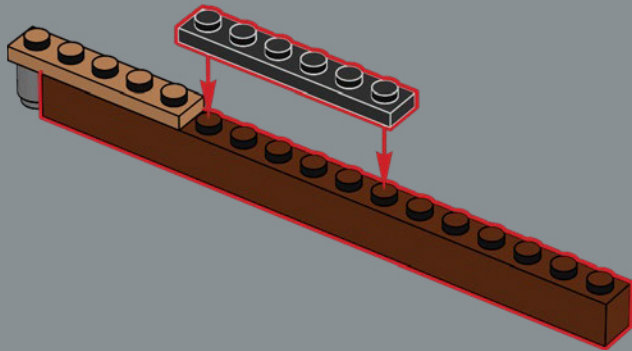

2x

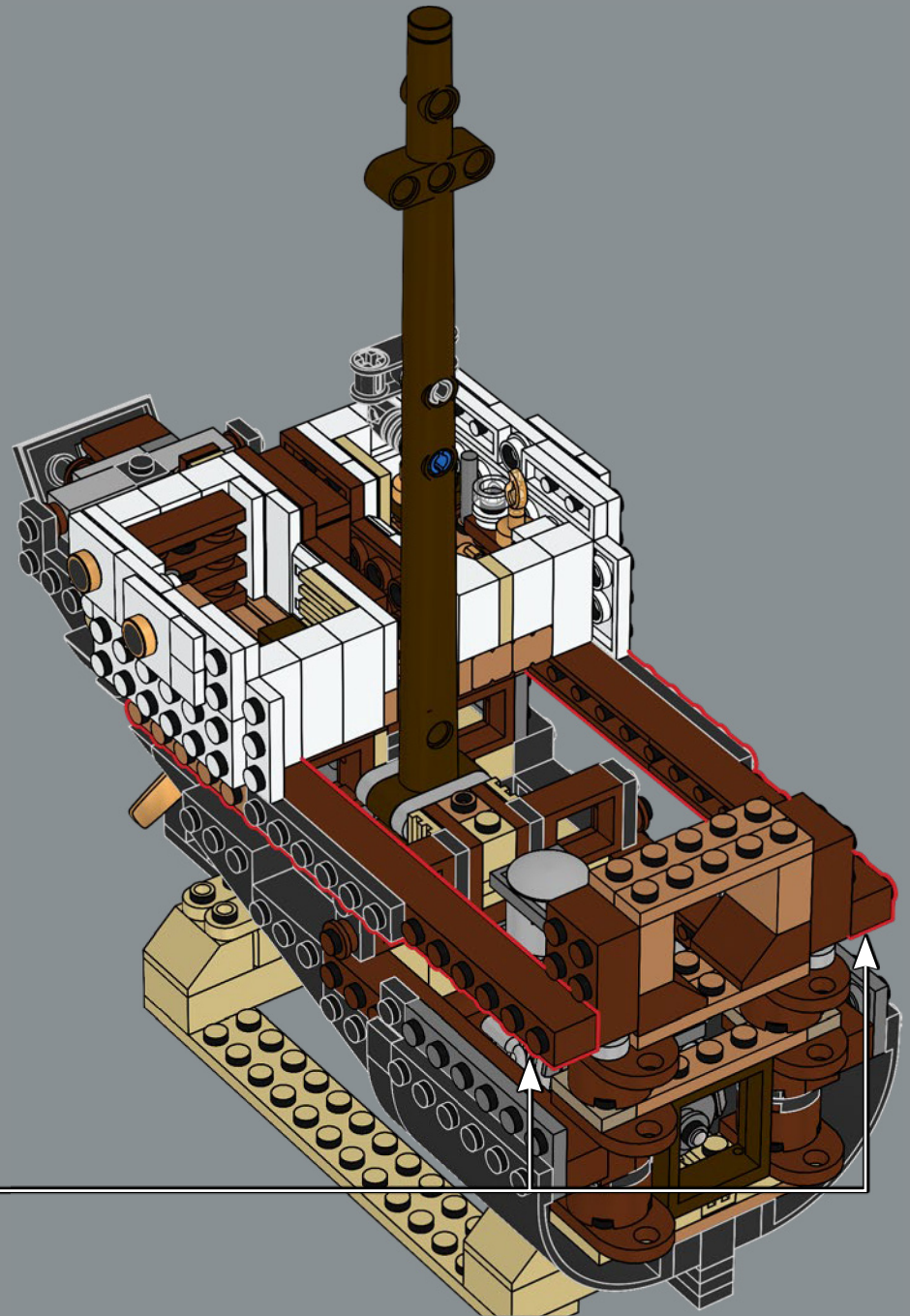

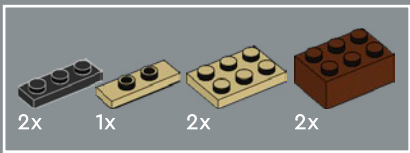

391

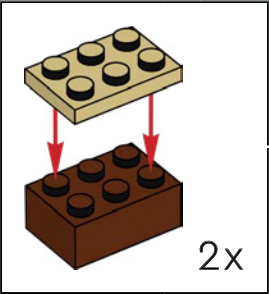
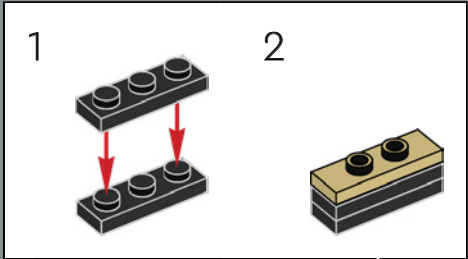
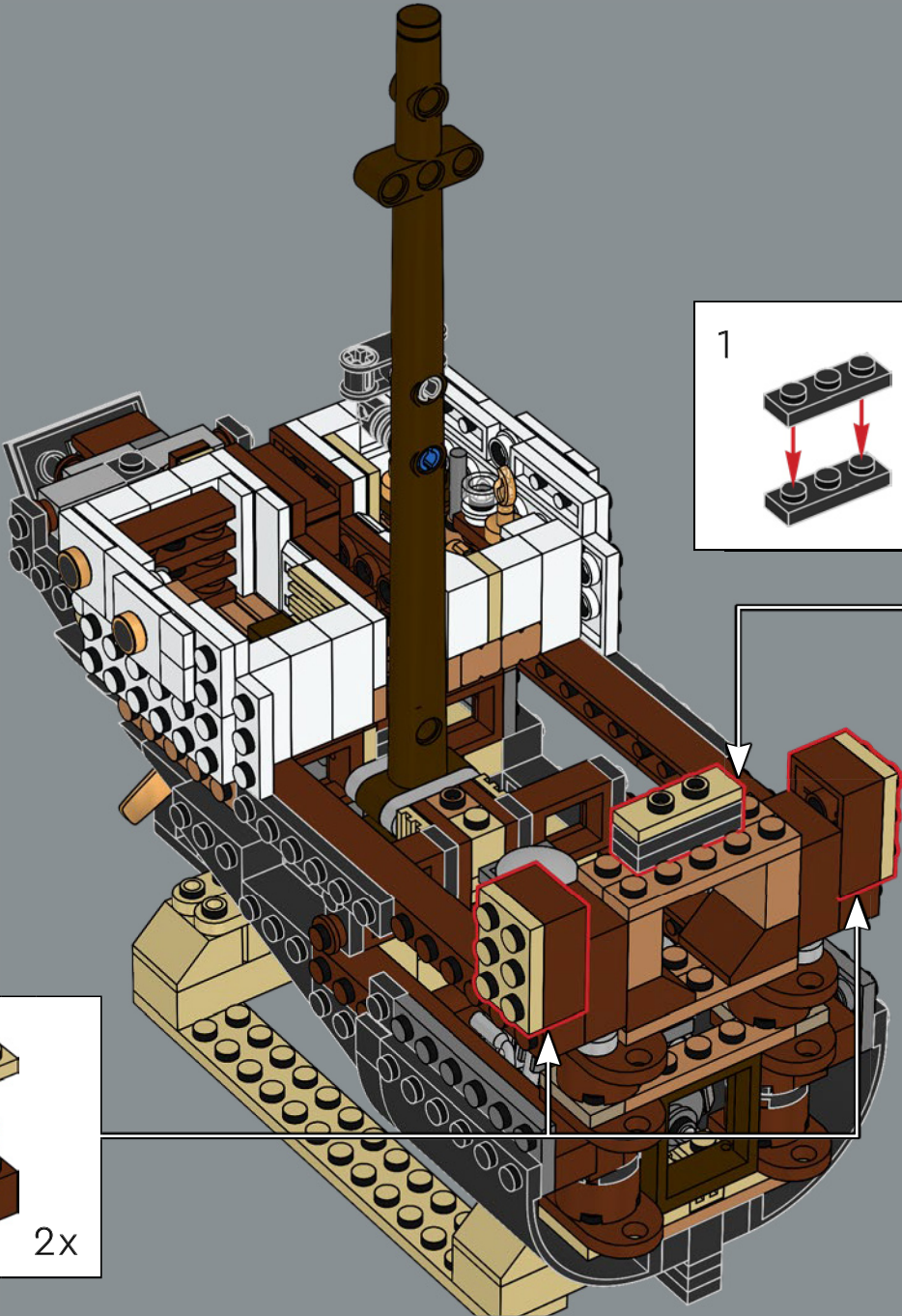

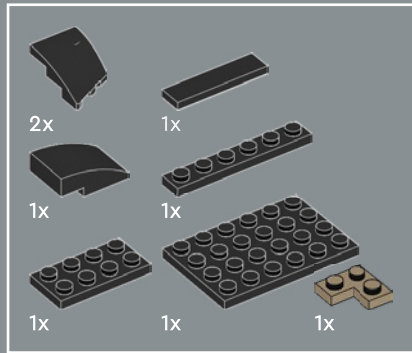

392

1

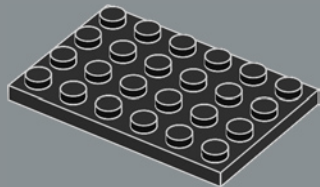

2

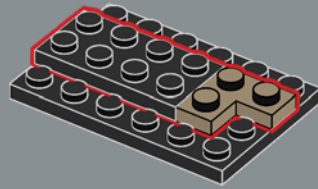

3

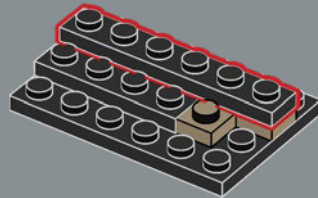

4

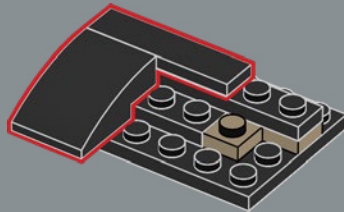

5

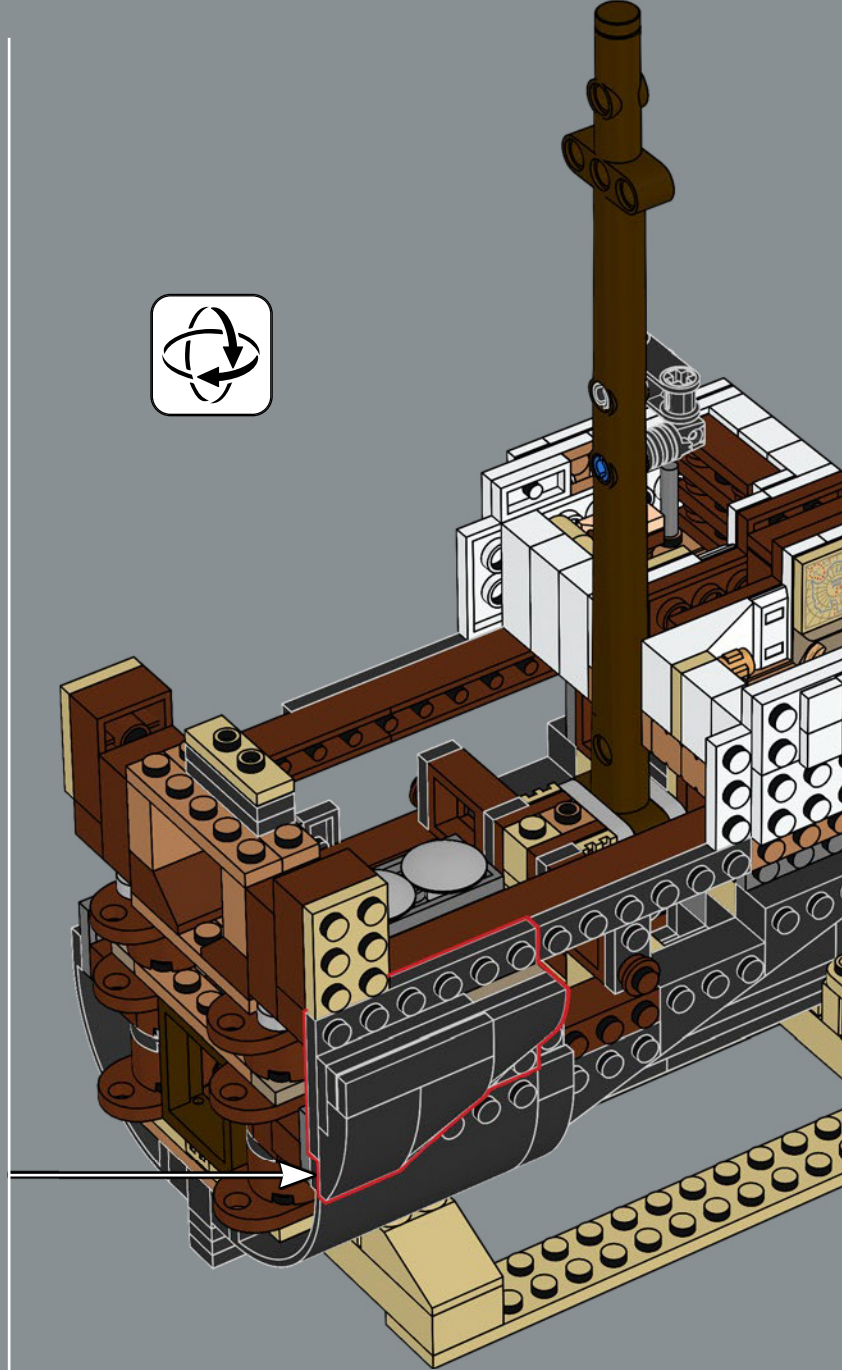
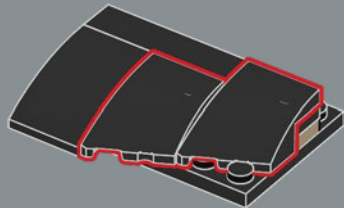

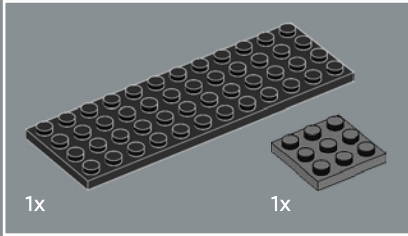
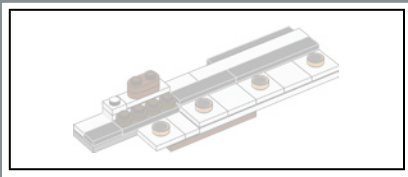

393

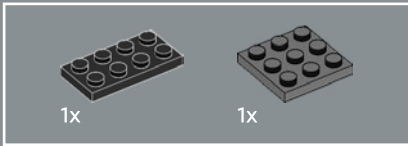
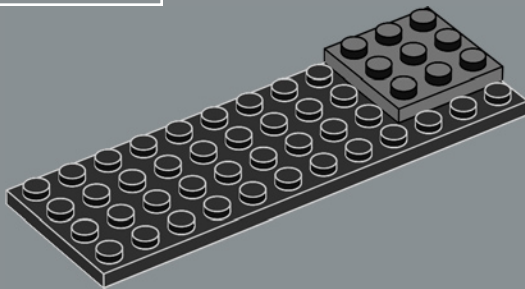

394

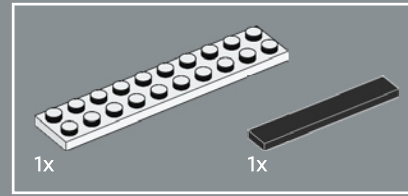
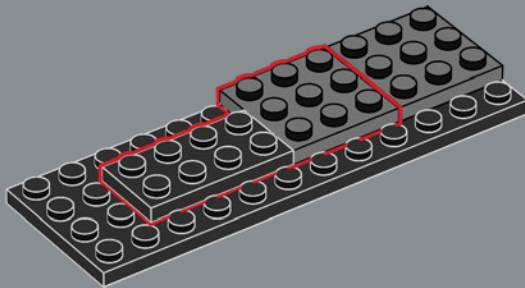

395

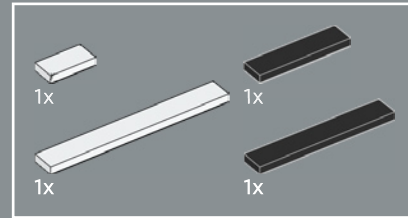
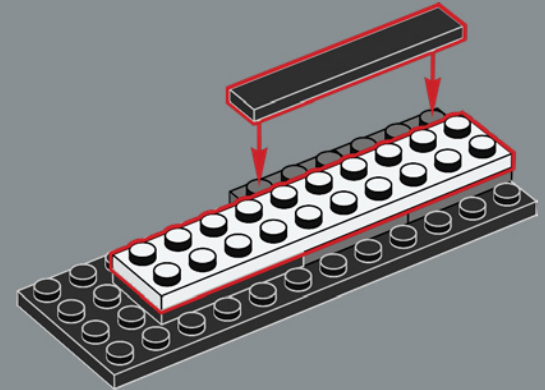

396

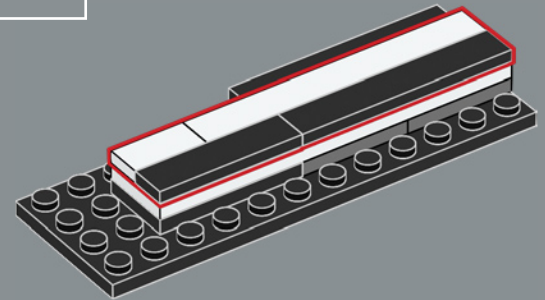

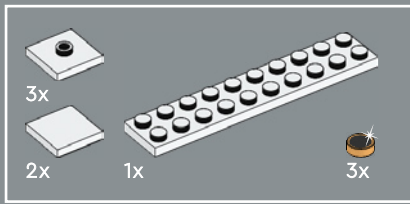

397

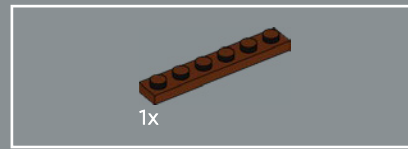
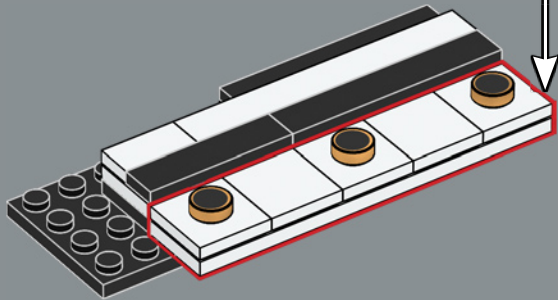
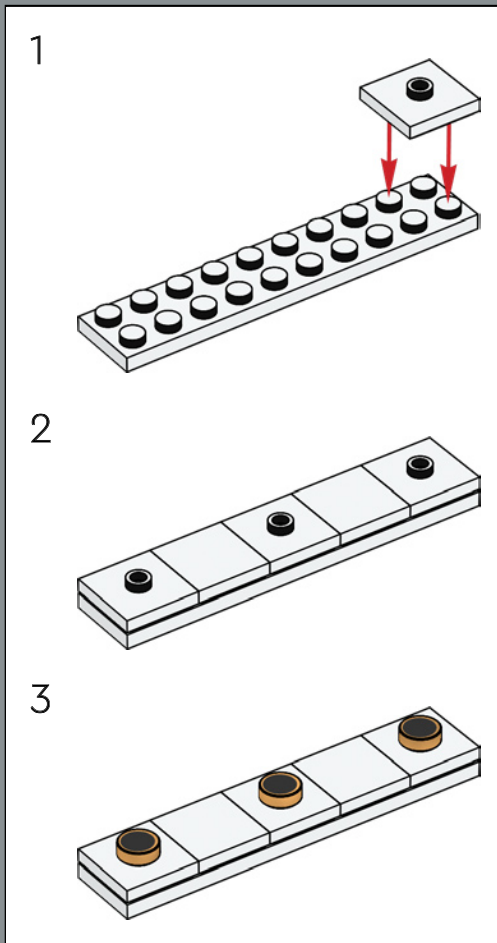

398

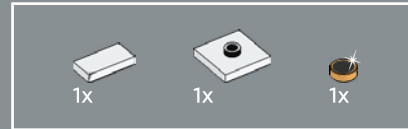
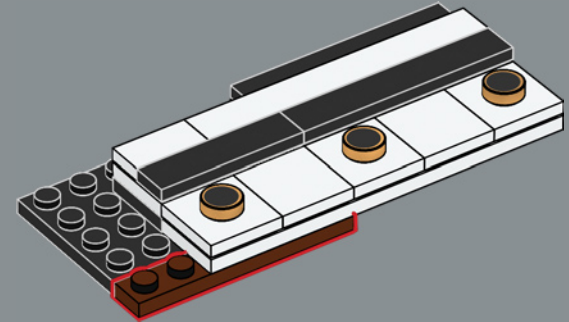

399

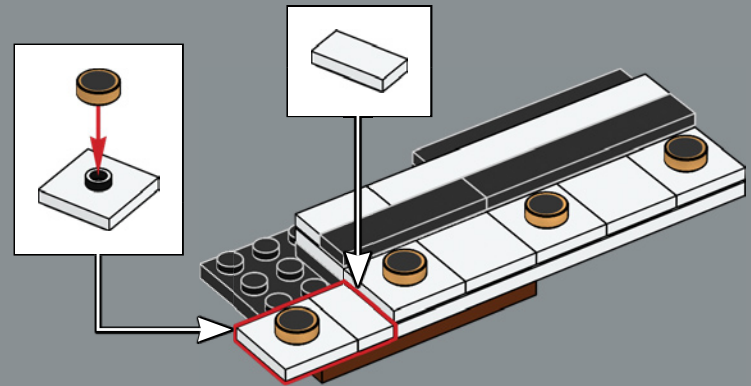

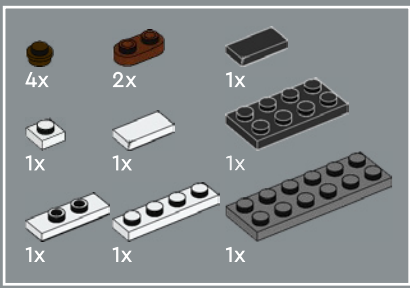

400

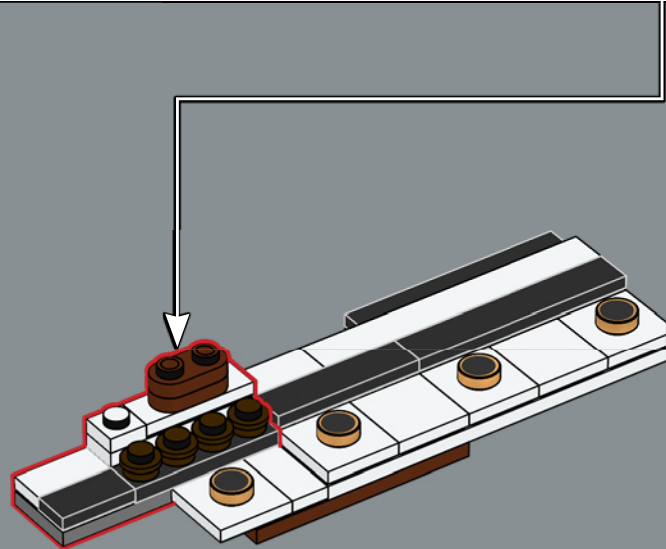
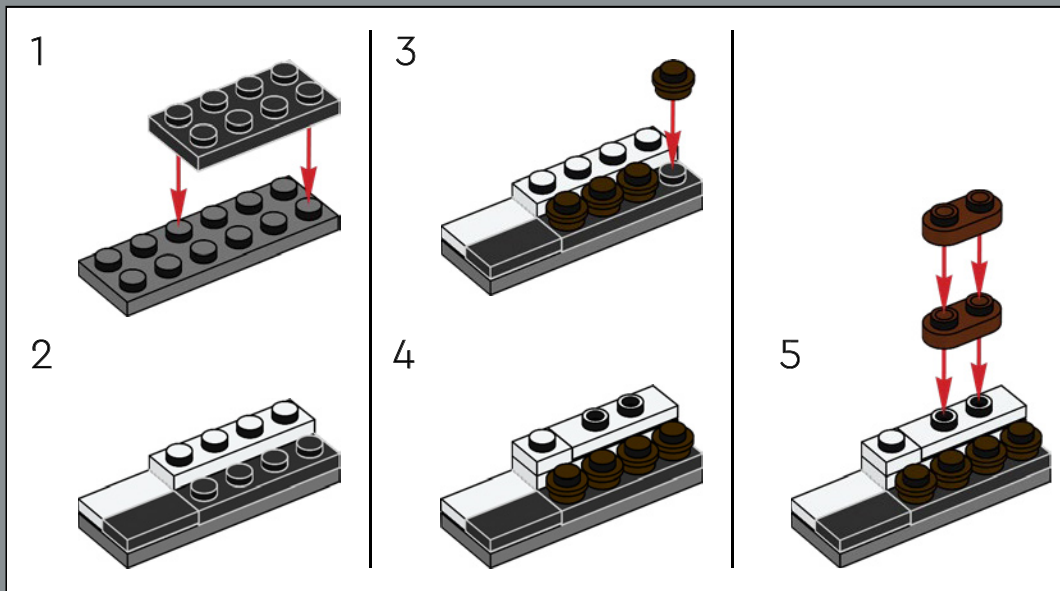

401

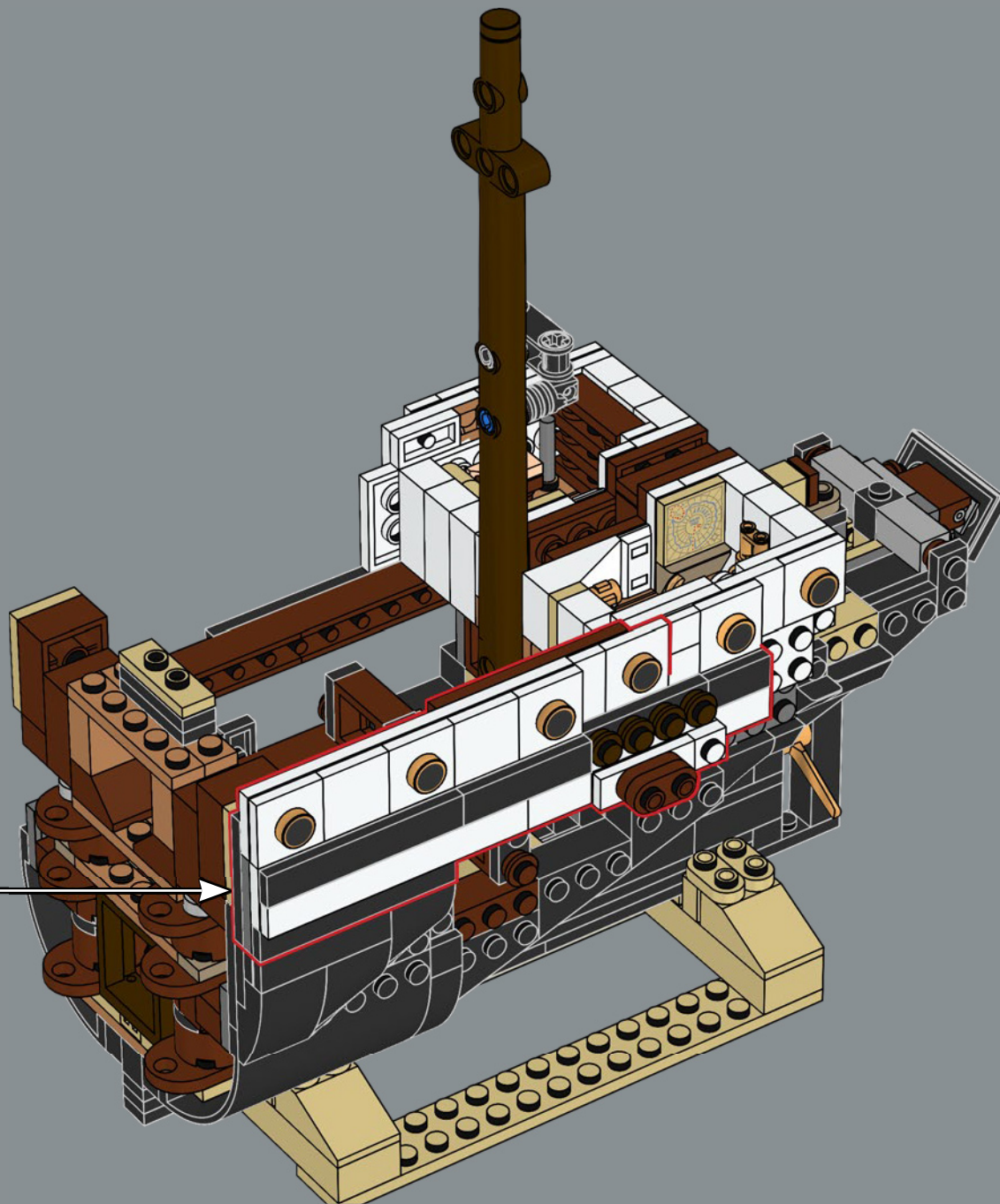

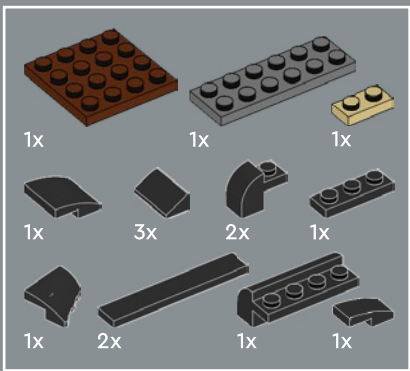

402

1

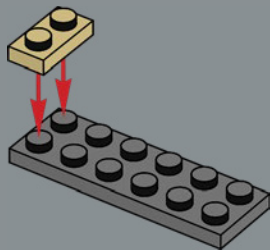

2

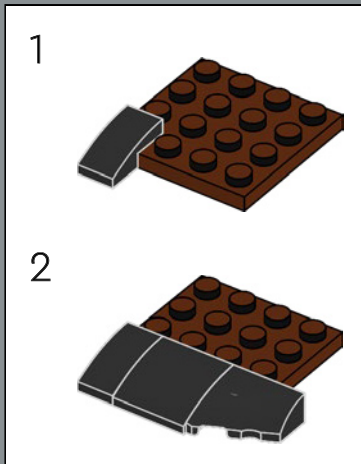
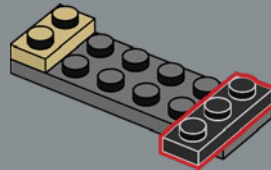

3

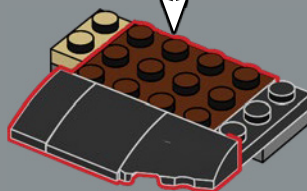

4

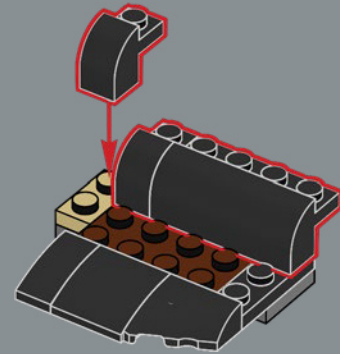

5

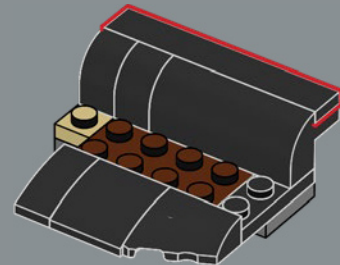

6

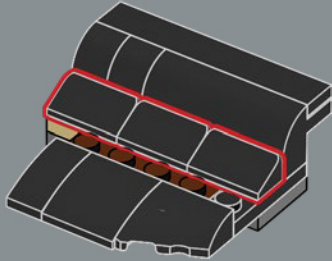

7

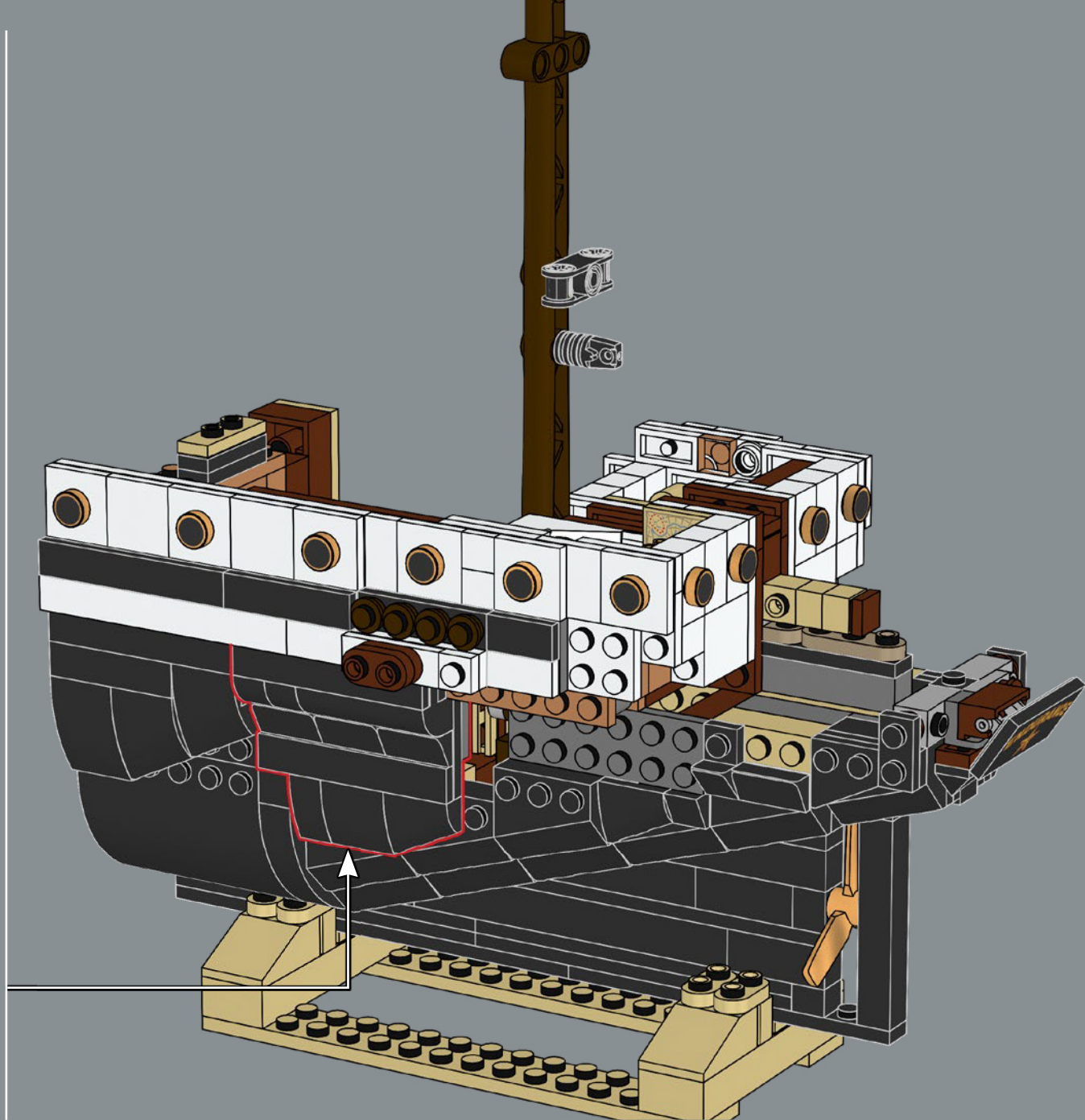
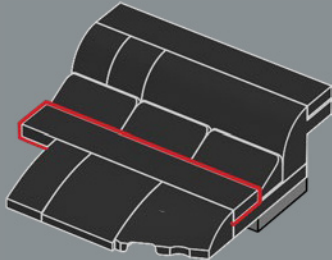

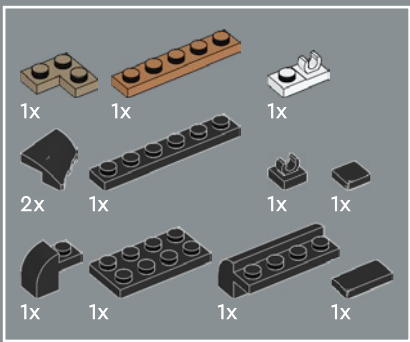

403

1

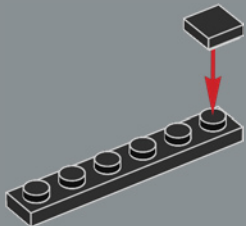

2

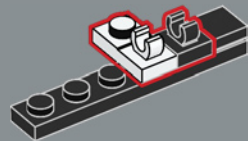

3

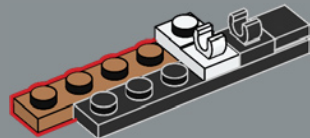

4

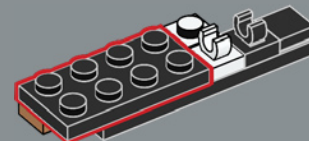

5

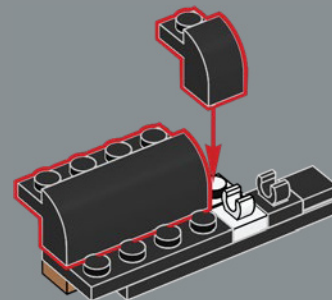

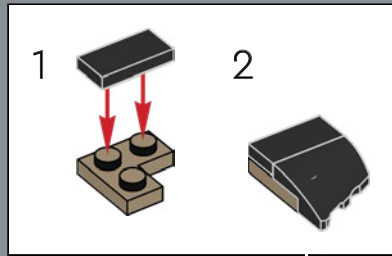

6

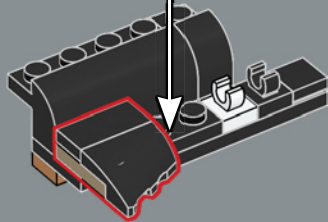

7

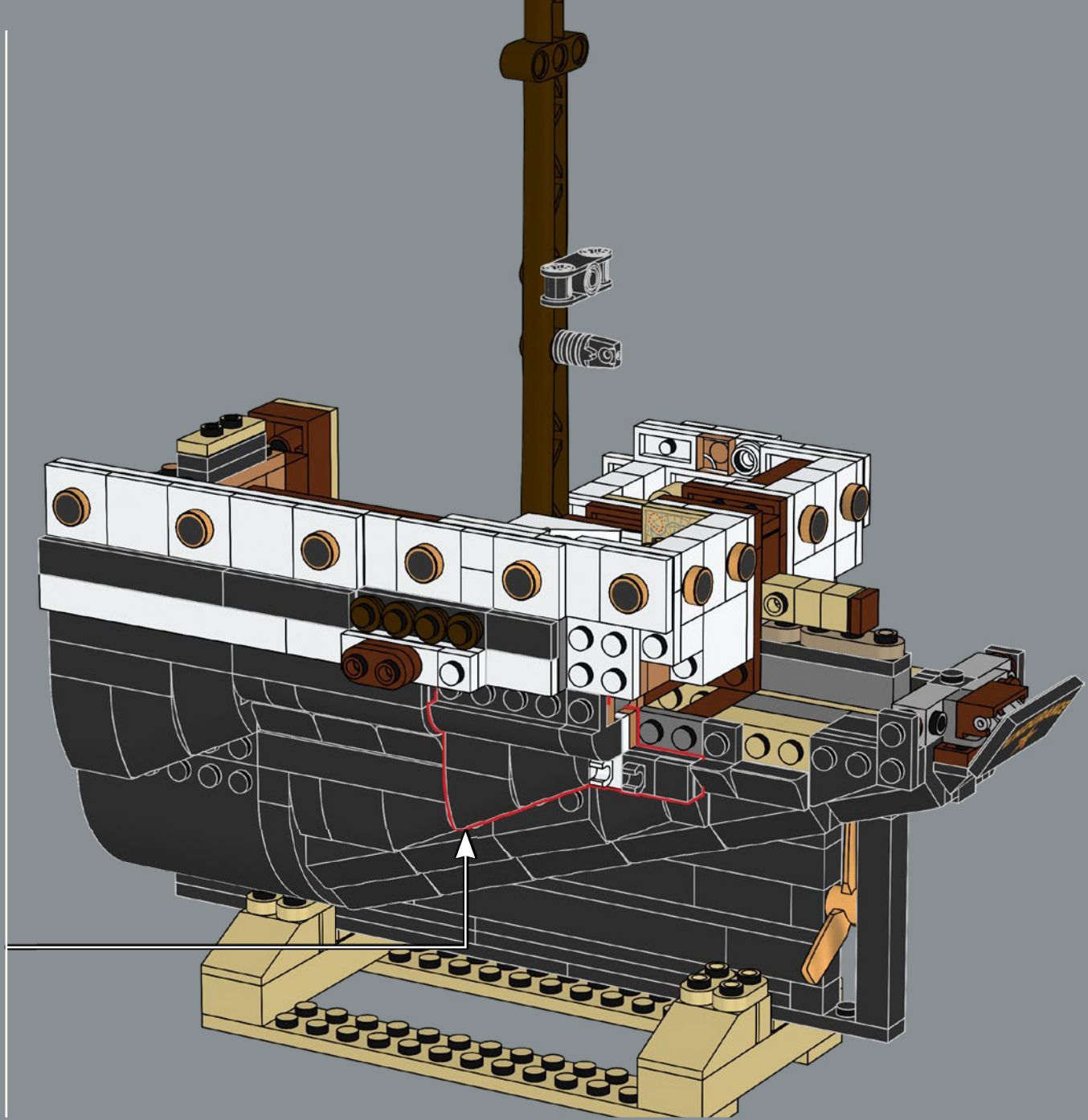
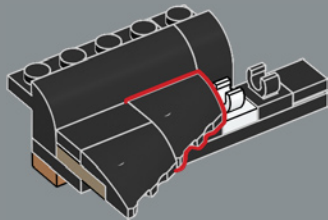

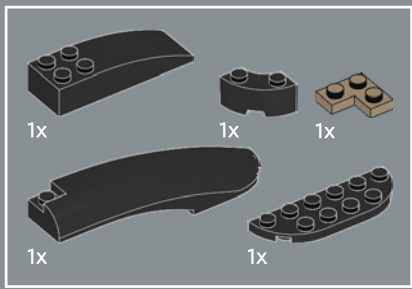

404

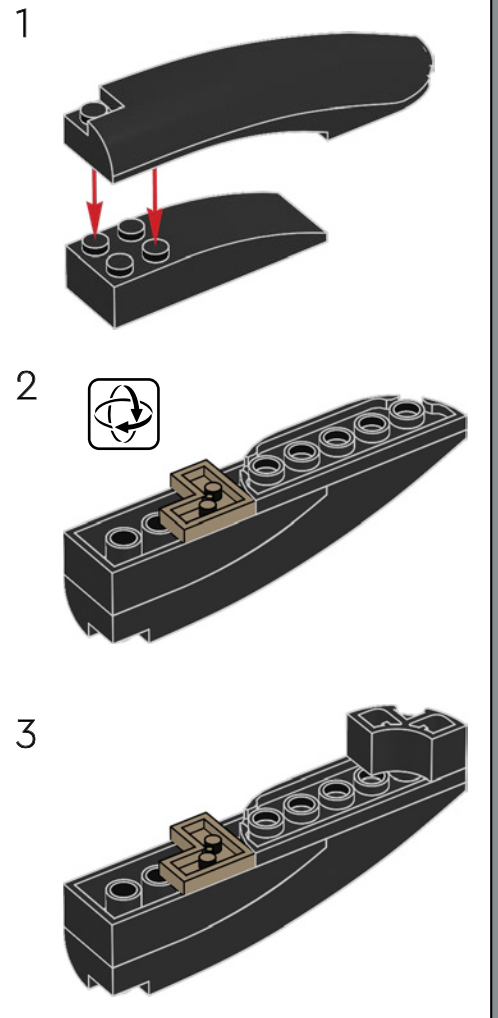
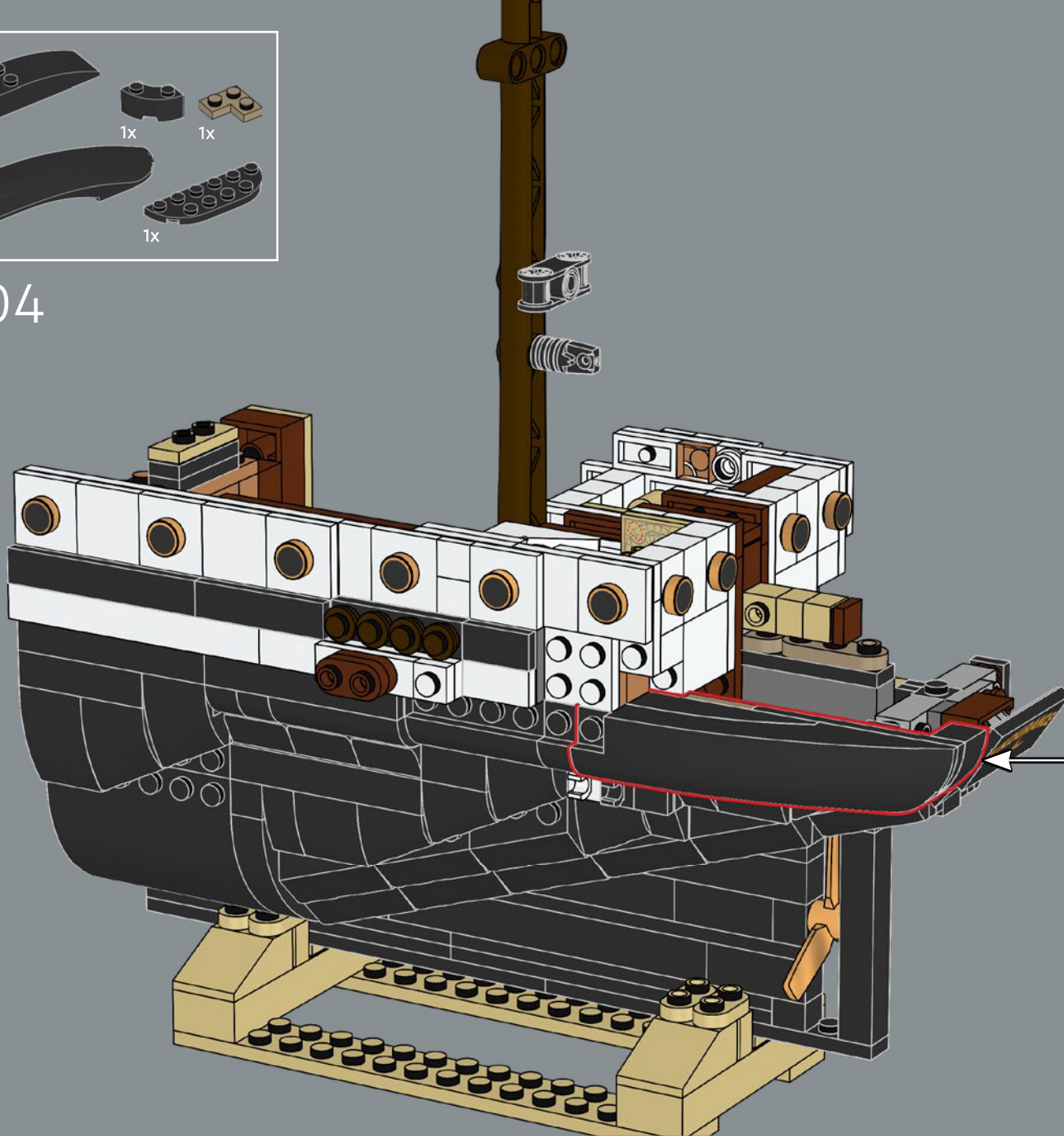

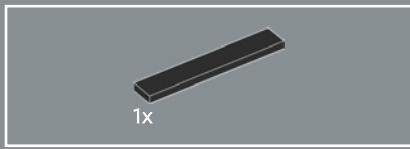

405

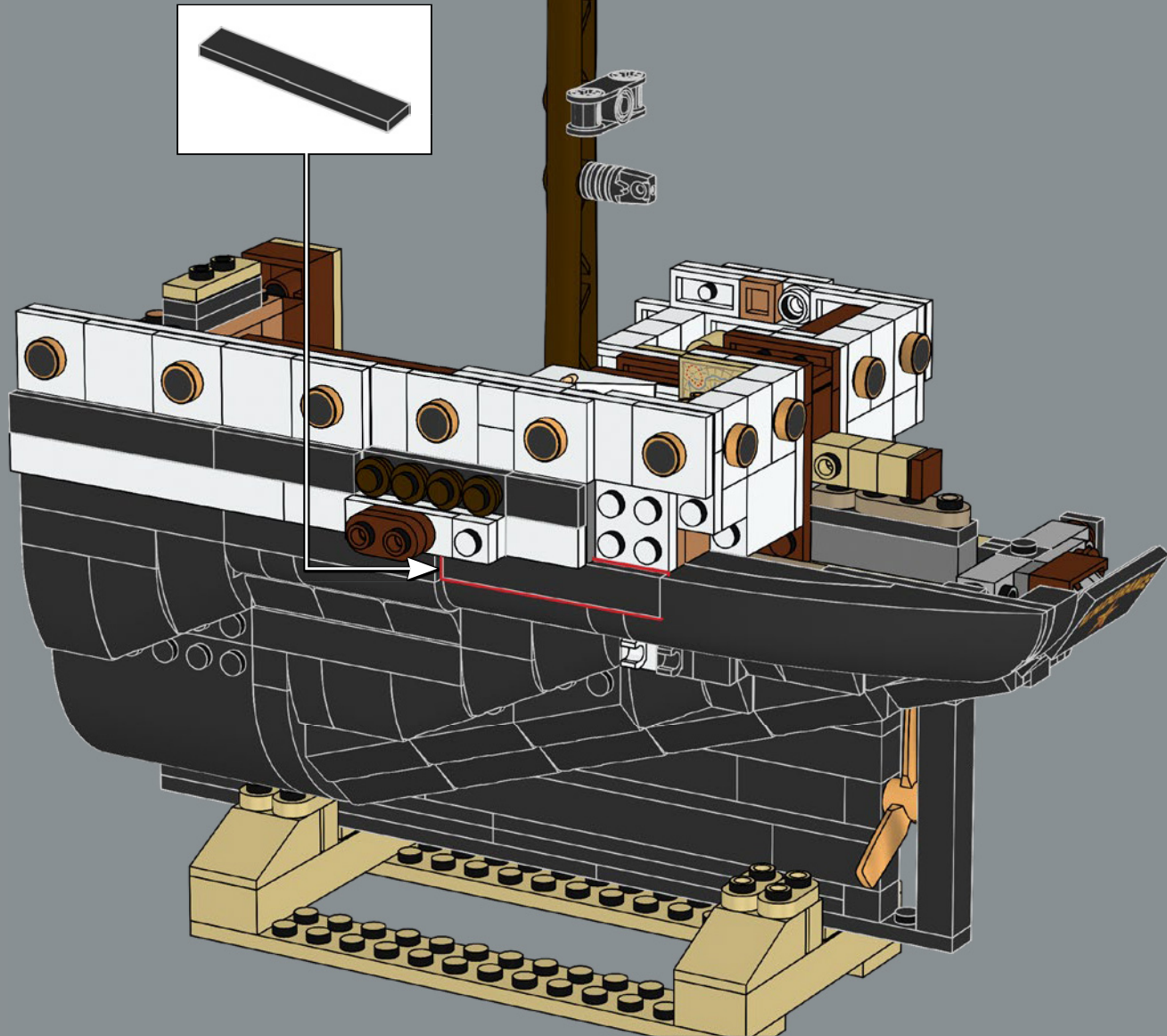

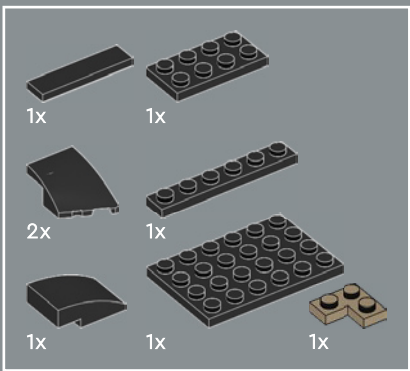
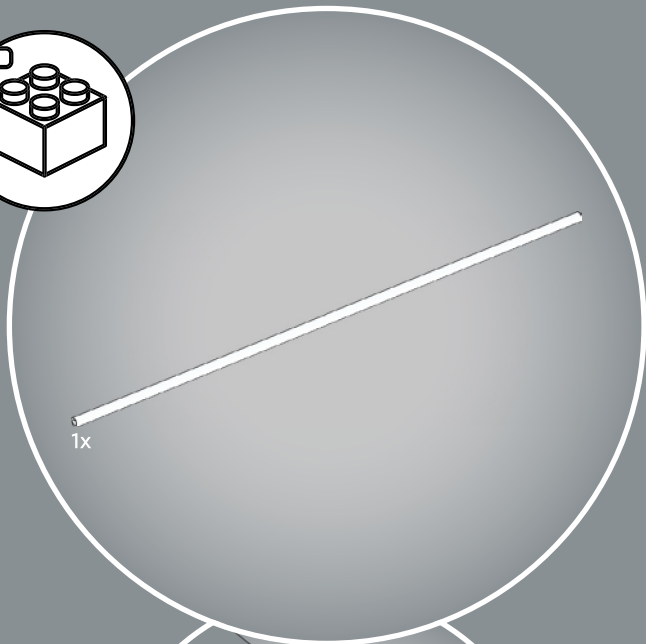
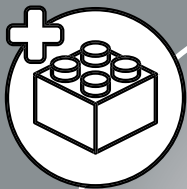

406



1

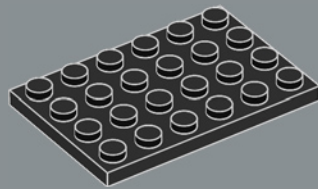

2

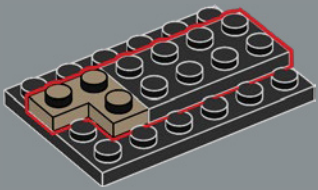

3

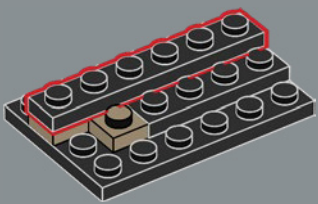

4

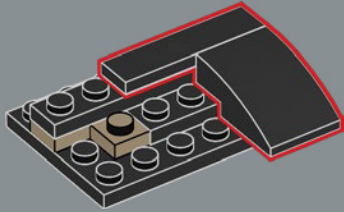

5

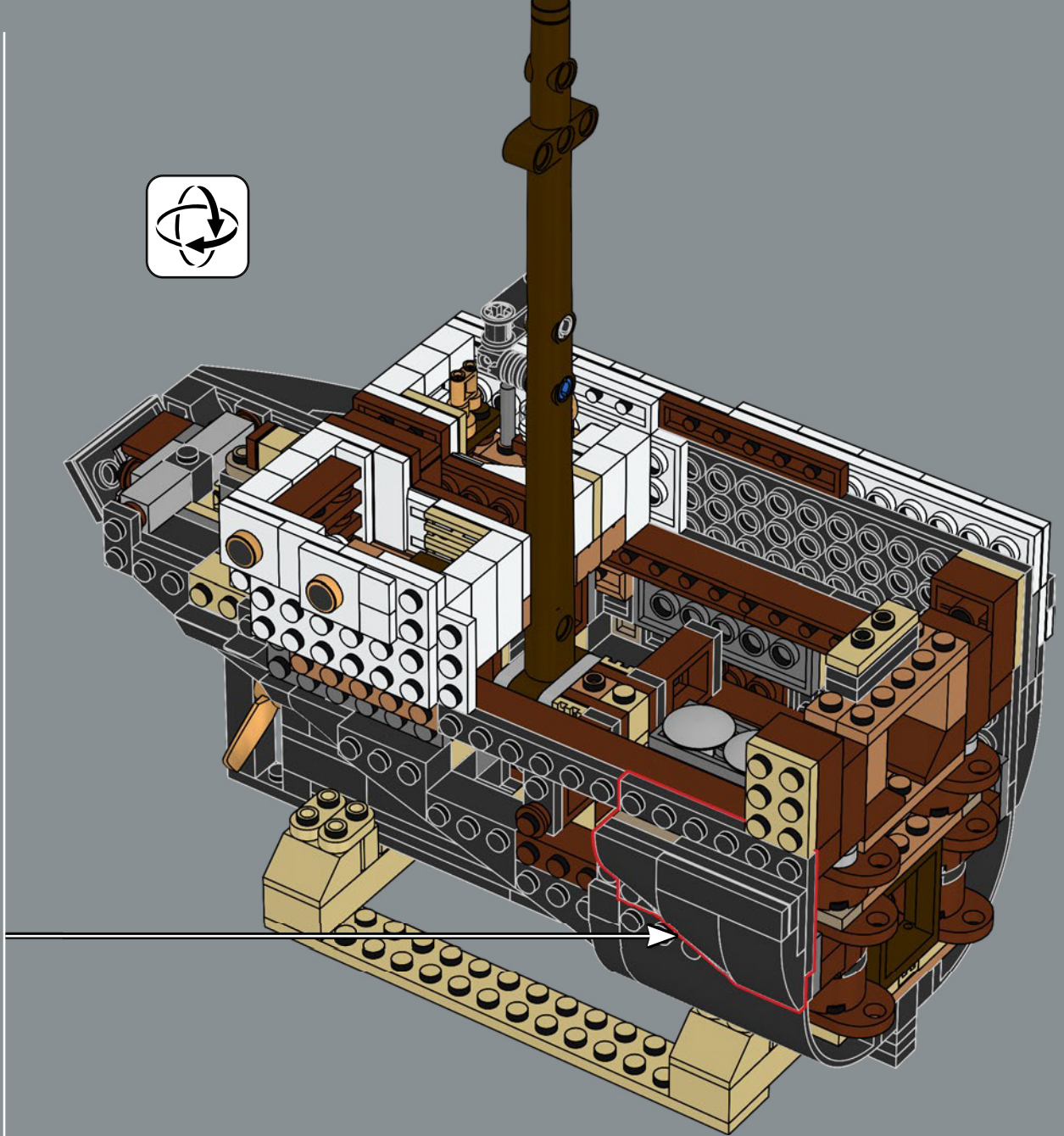
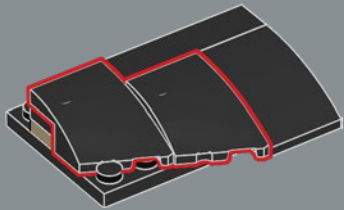

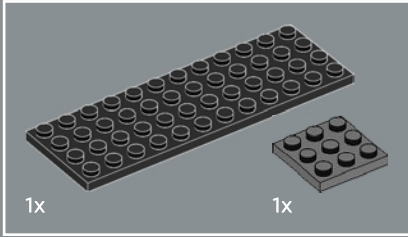
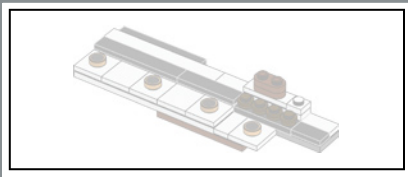

407

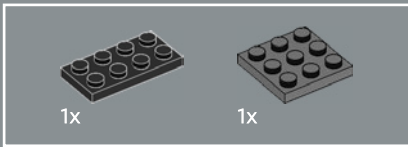
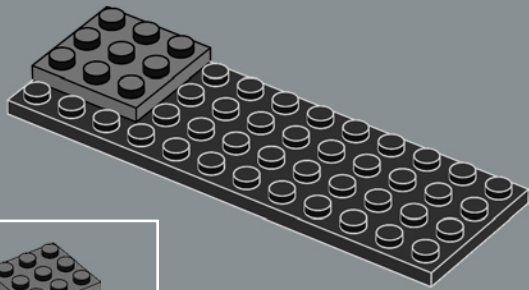

408

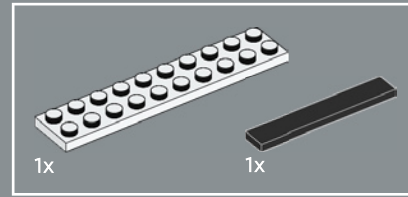
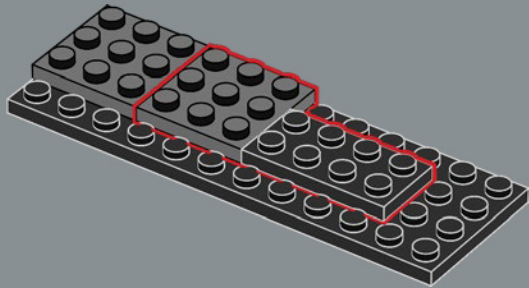

409

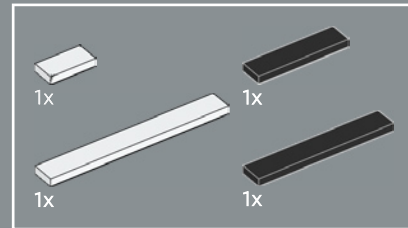
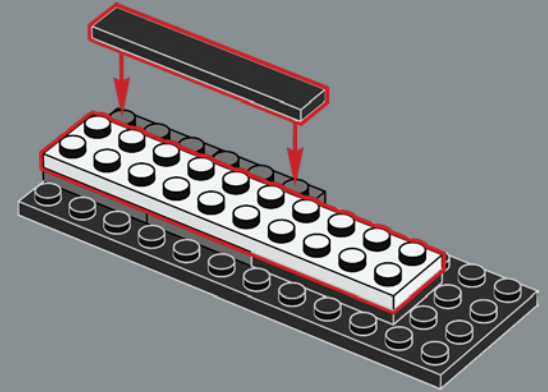

410

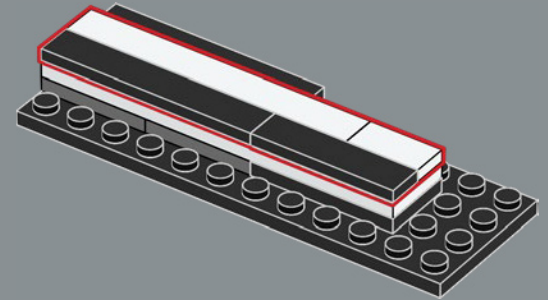

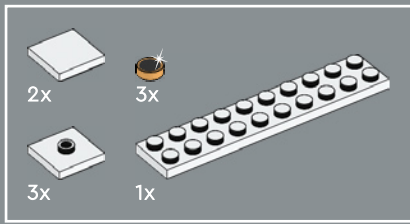

411

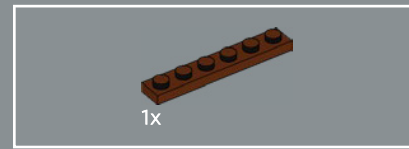
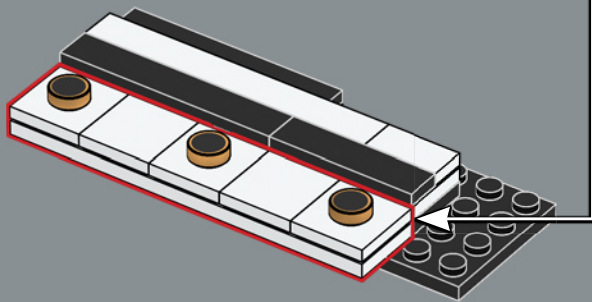
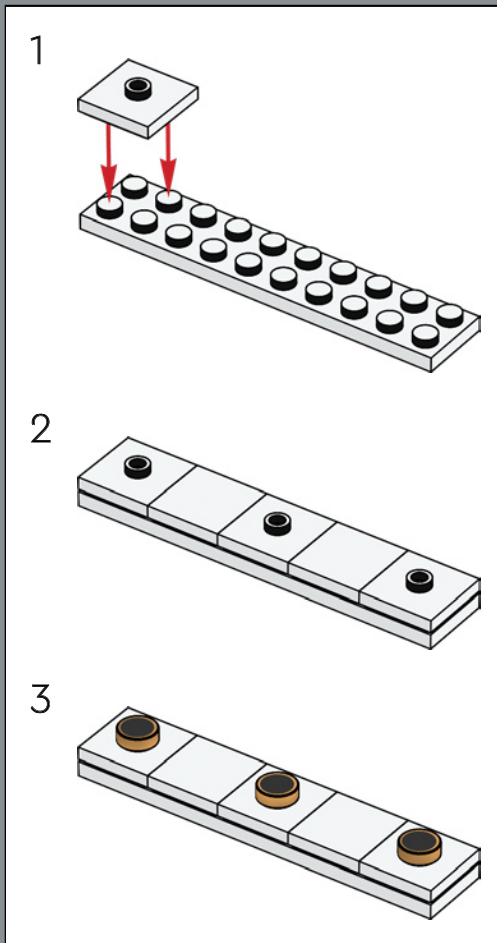

412

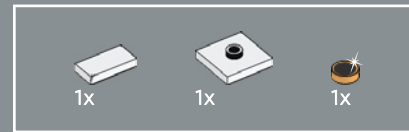
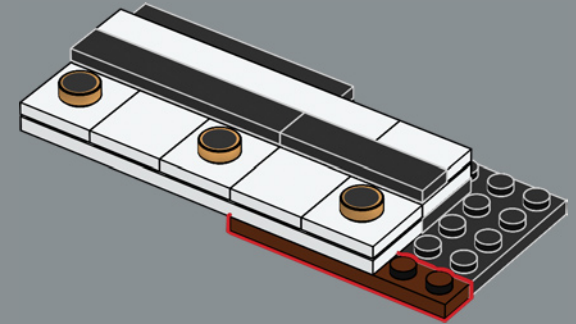

413

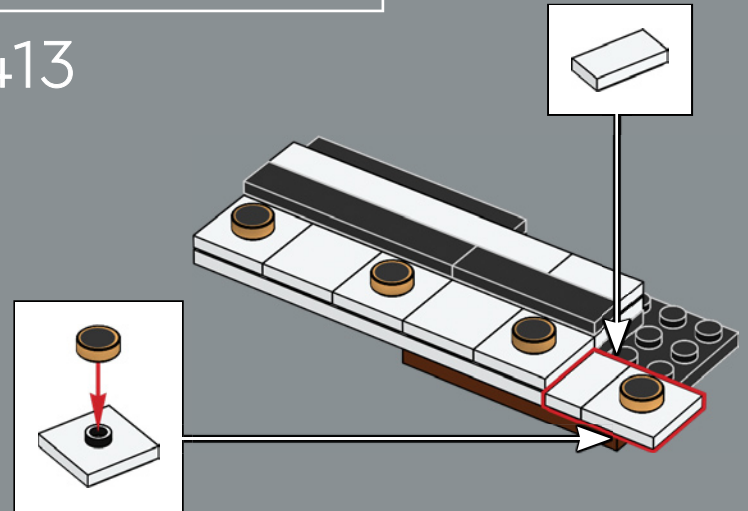

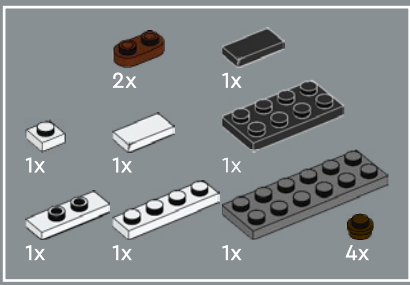

414

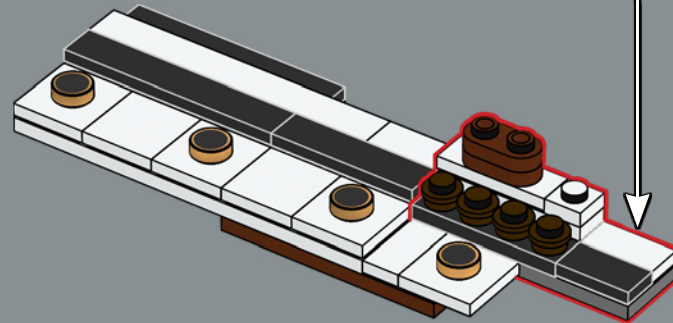
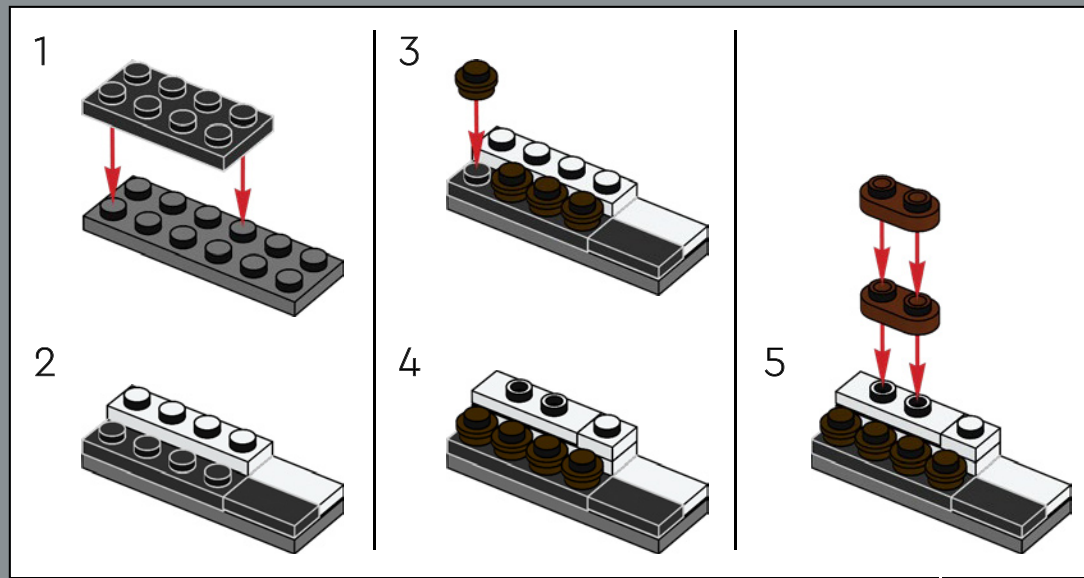

415

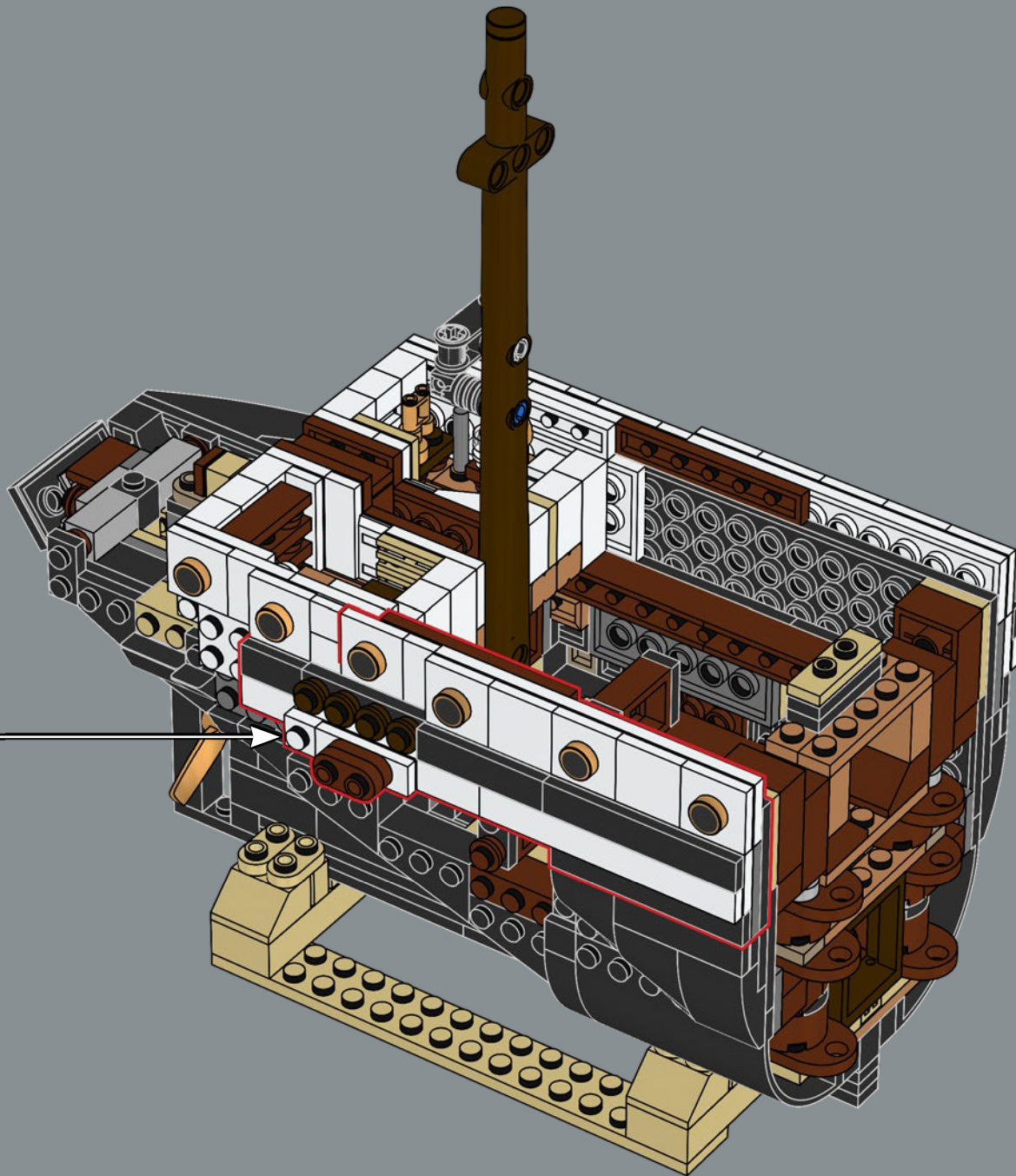

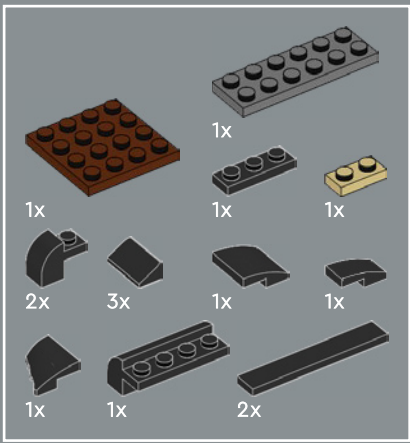

416

1

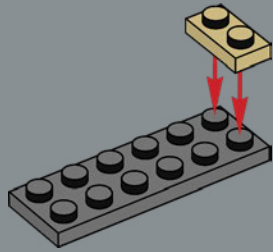

2

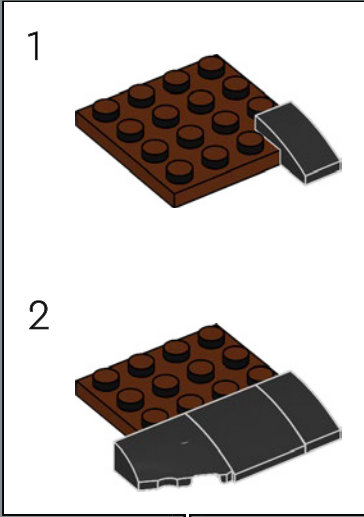
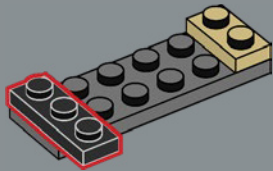

3

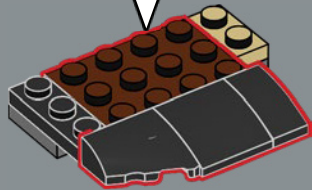

4

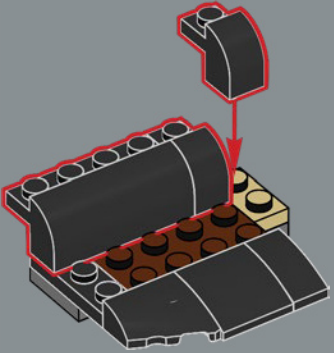

5

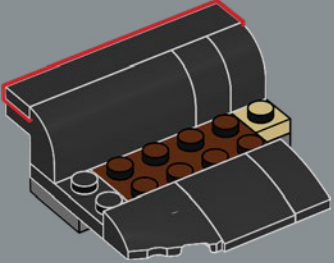

6

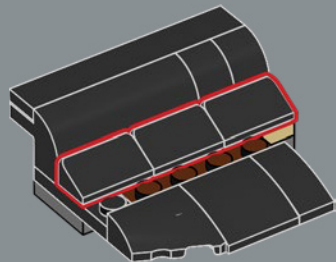

7

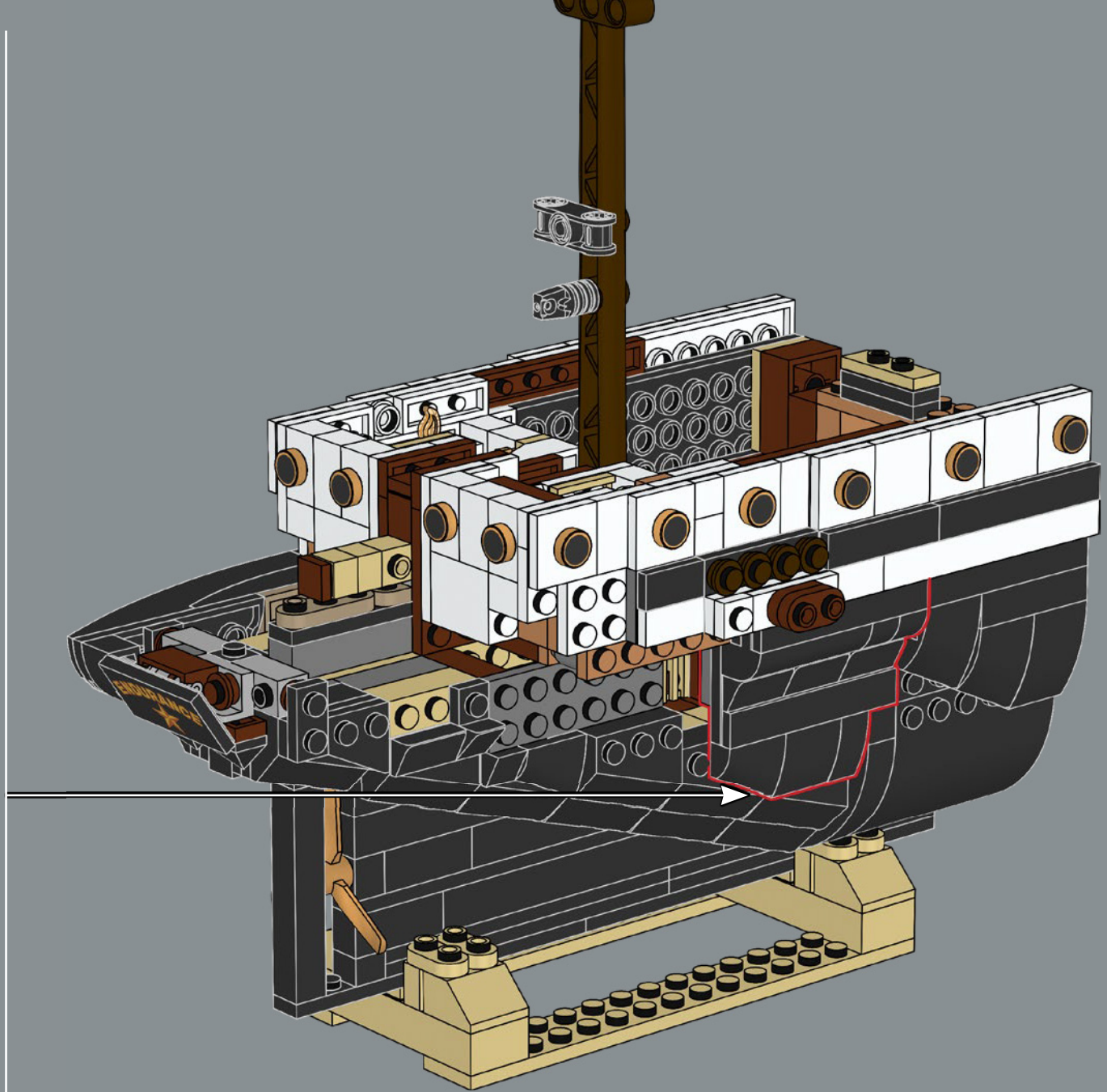
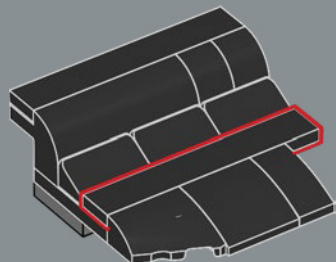

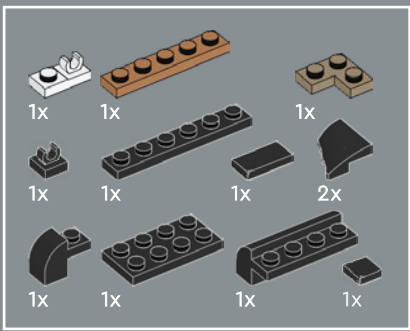

417

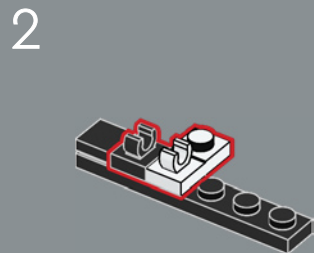
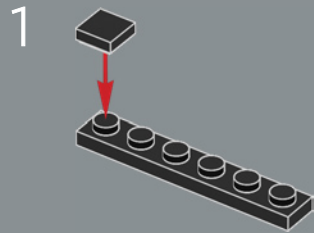

3

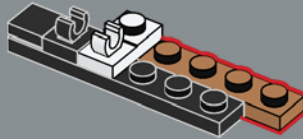

4

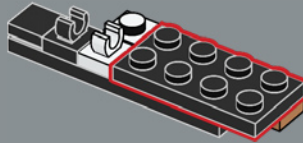

5

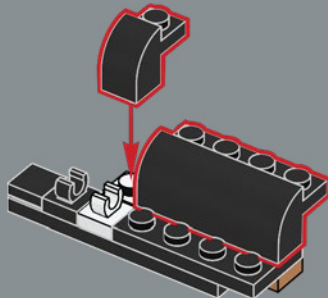

6

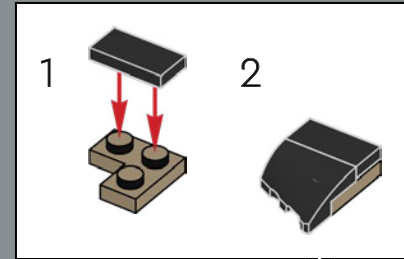

7

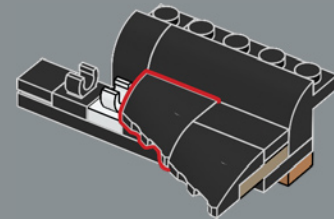

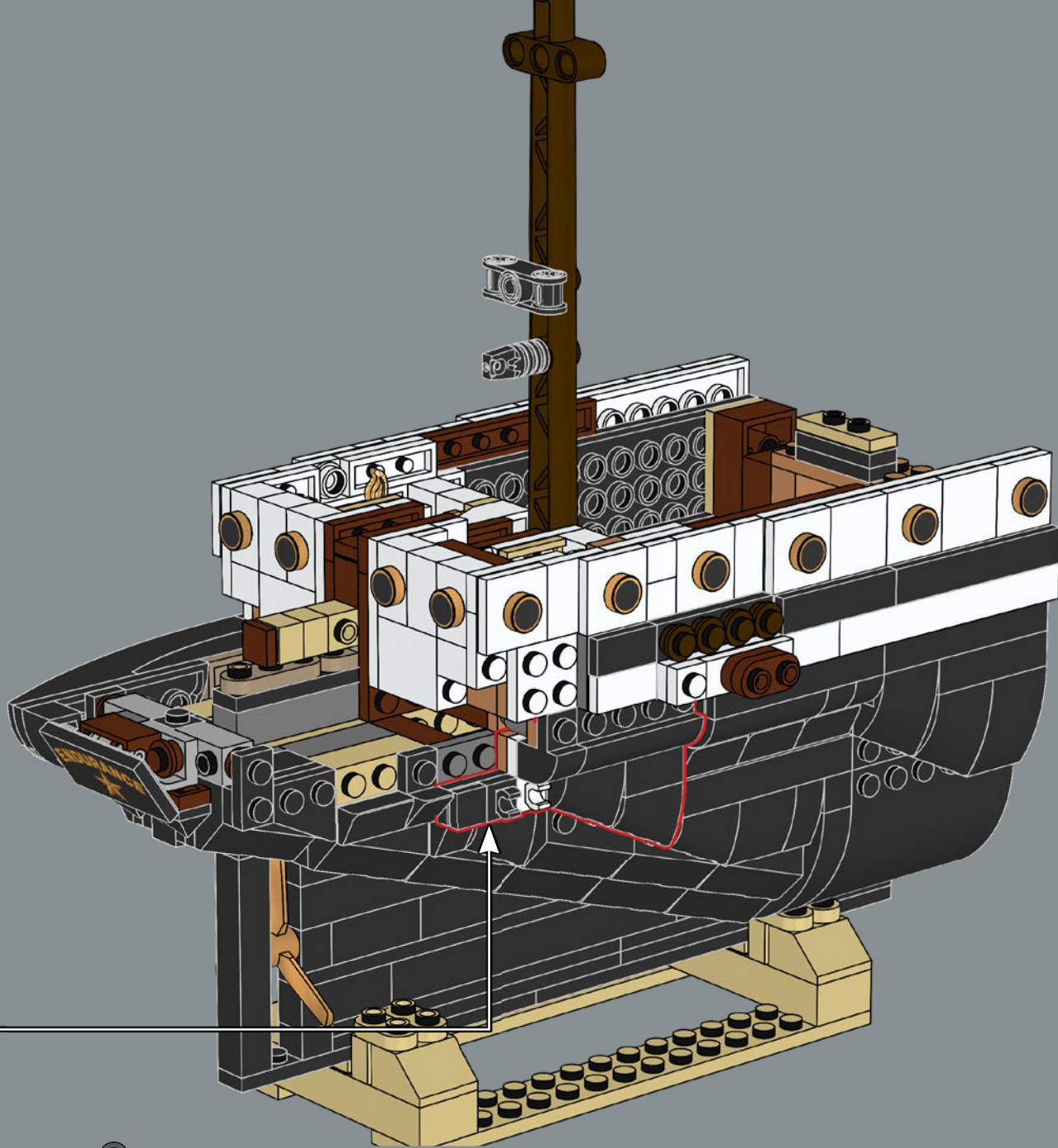

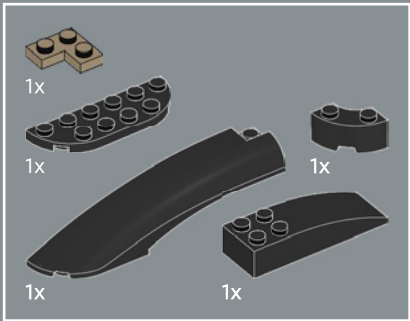

418

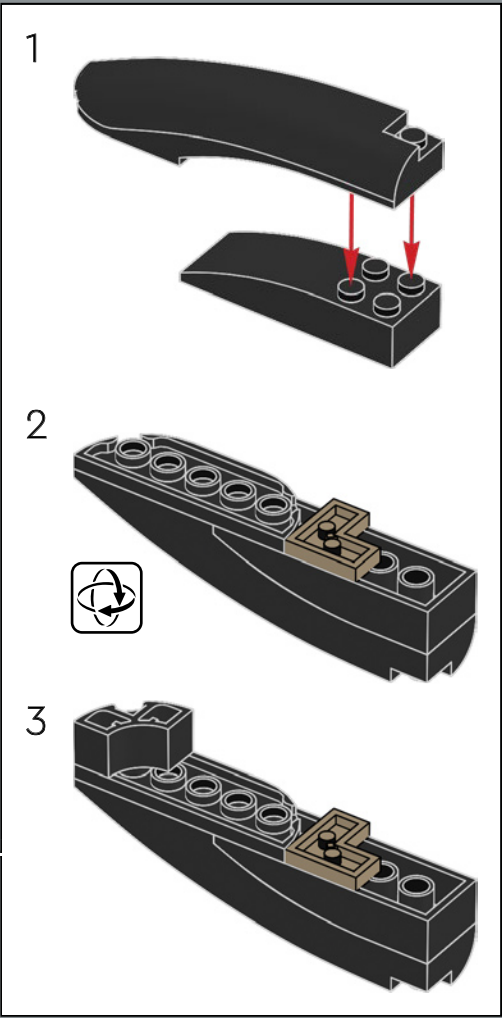
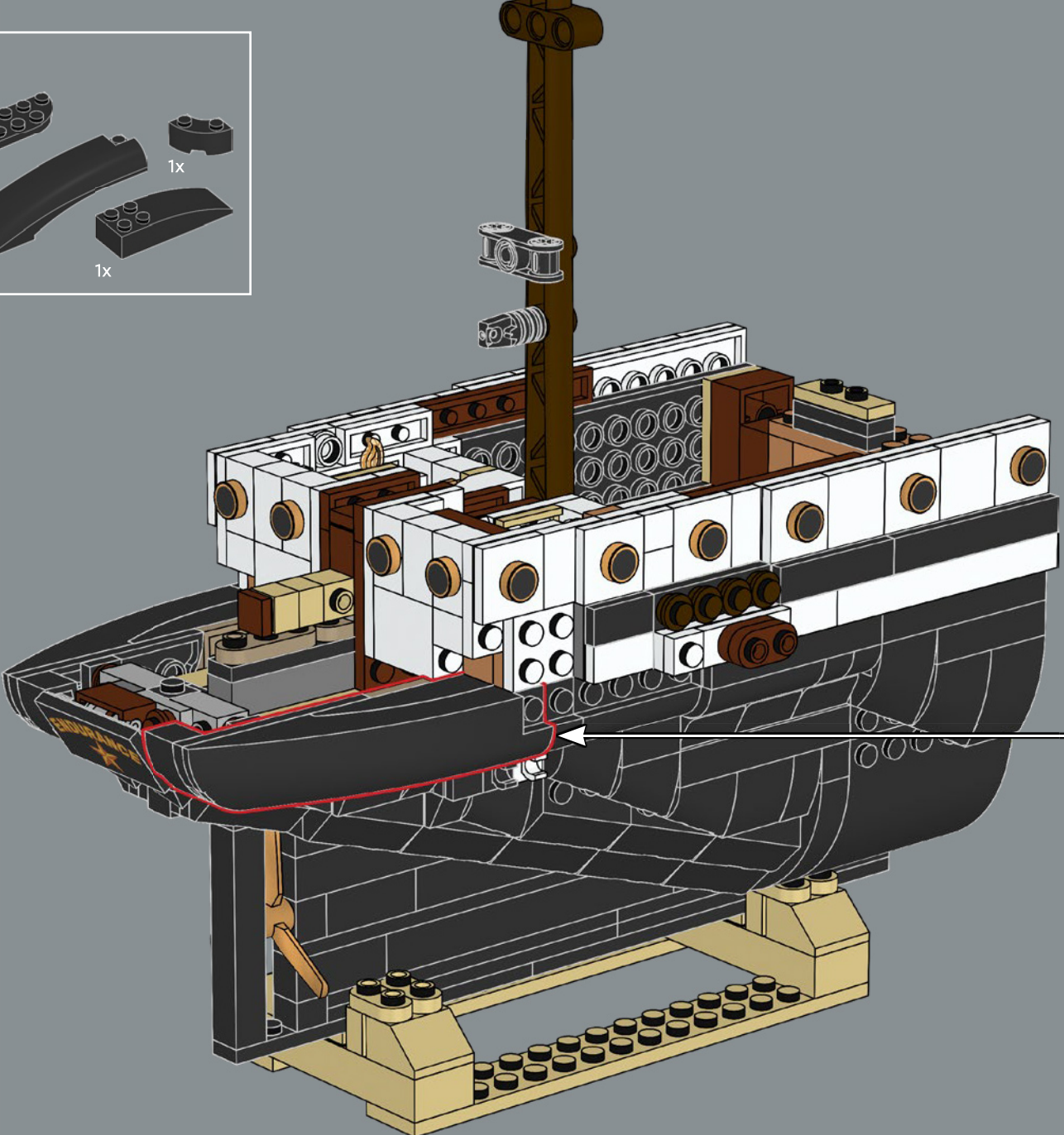

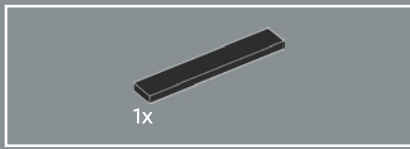

419

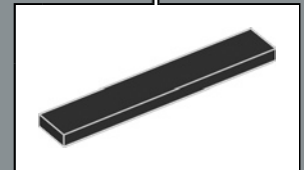
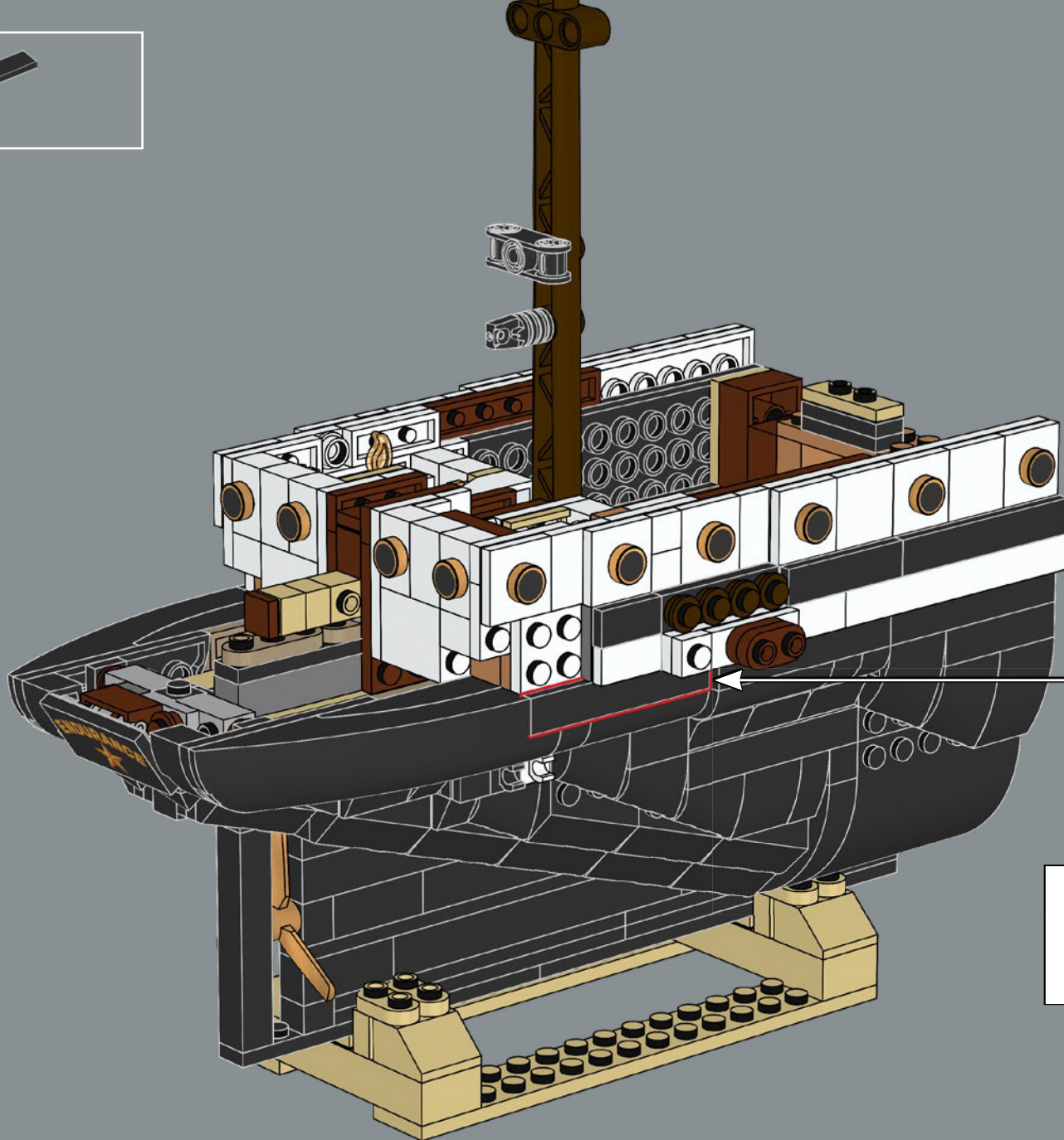

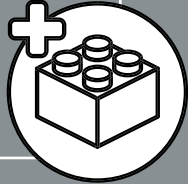
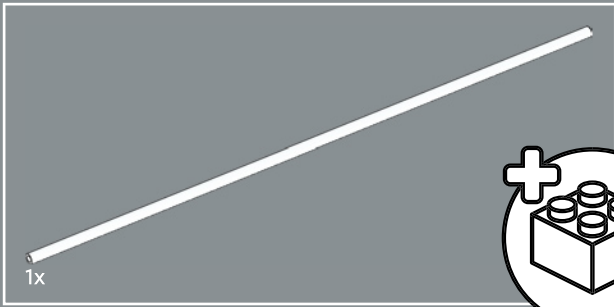

420

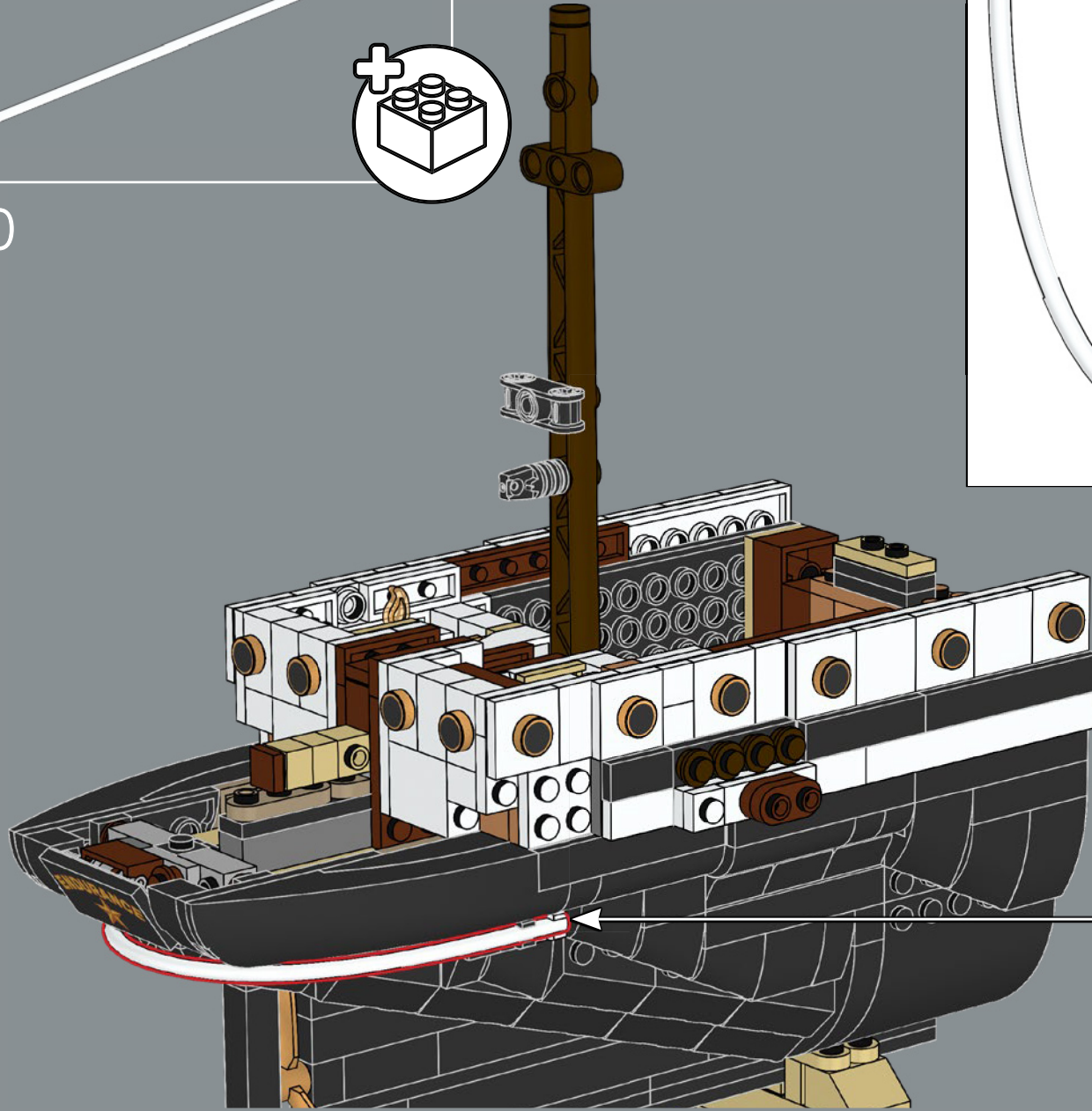
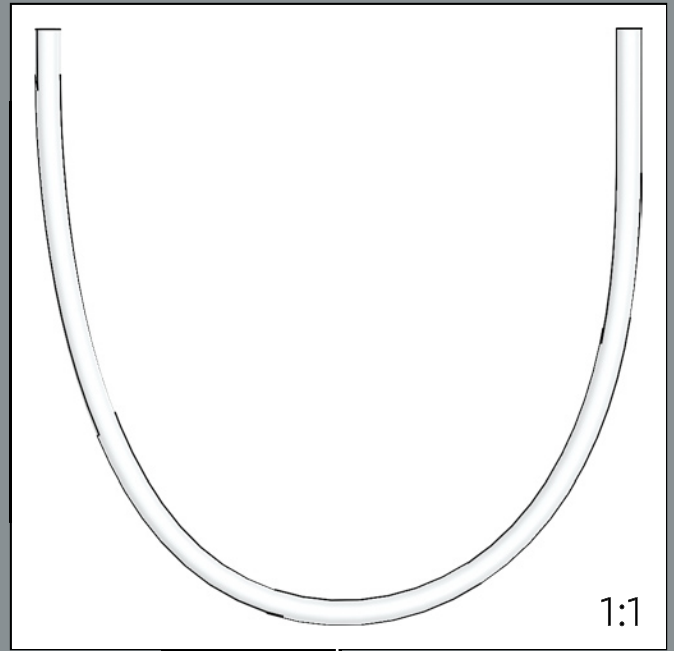

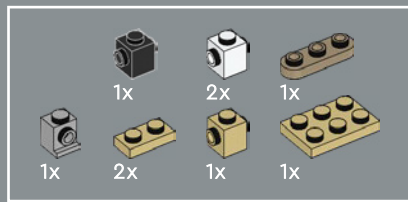
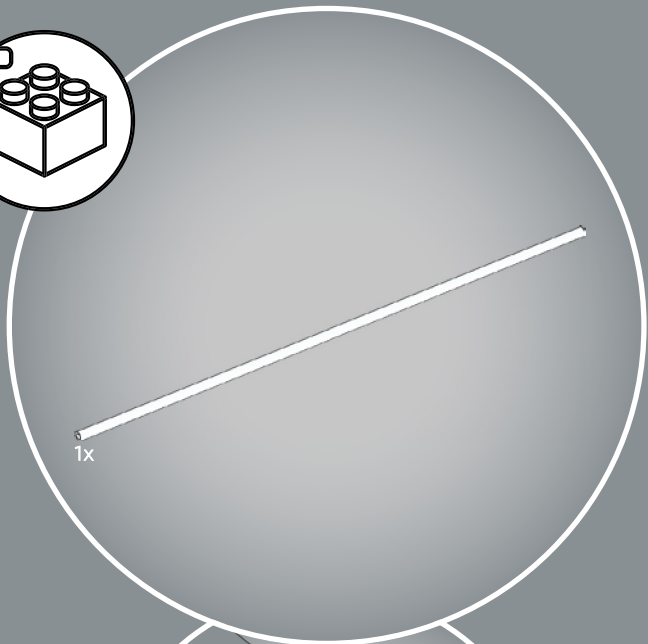
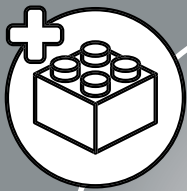

421

1

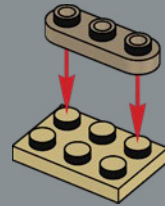

2

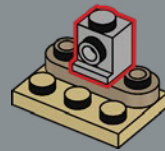

3

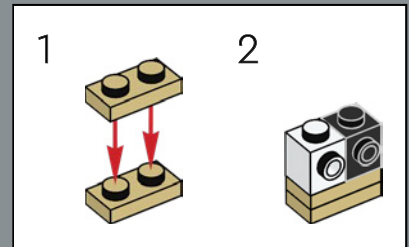
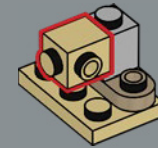

4

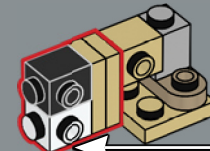

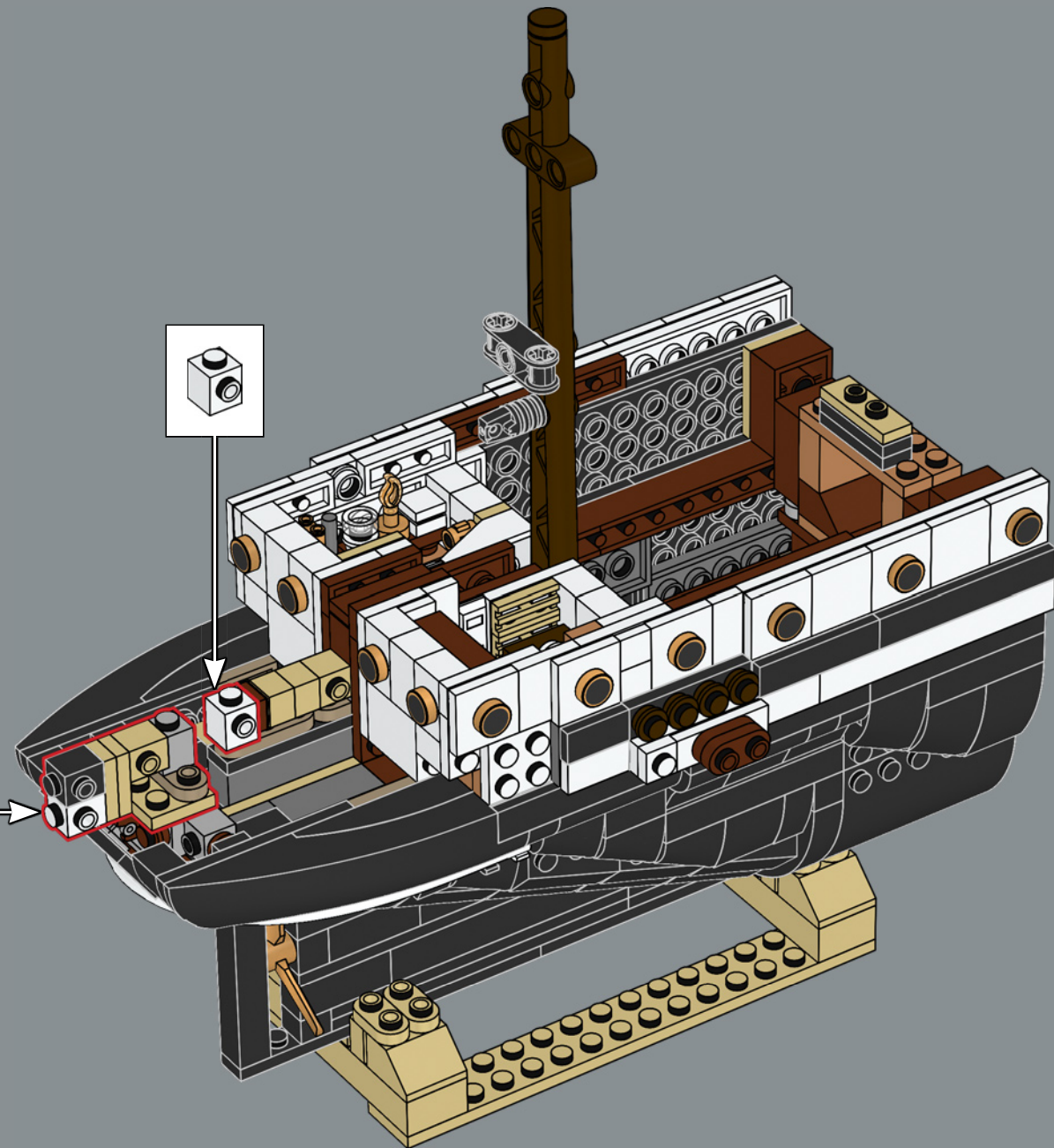

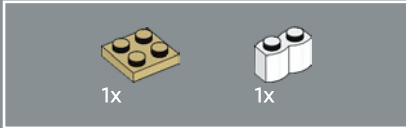
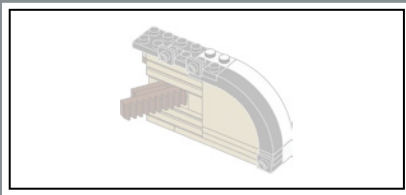

422

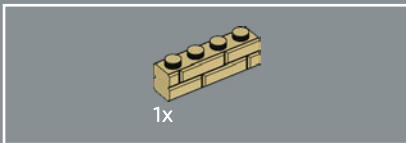
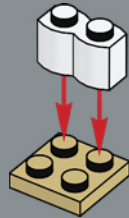

423

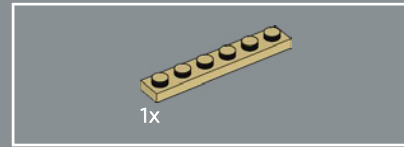
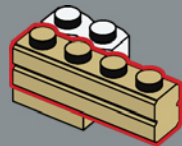

424

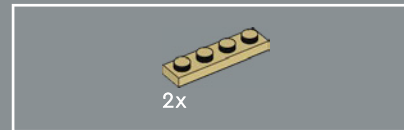
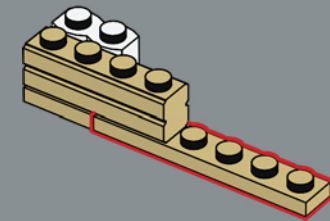

425

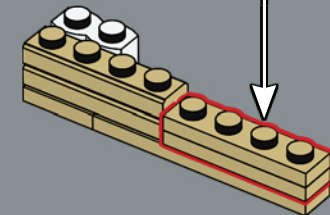
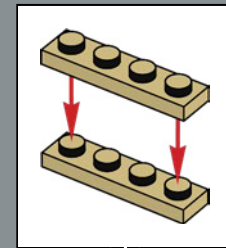

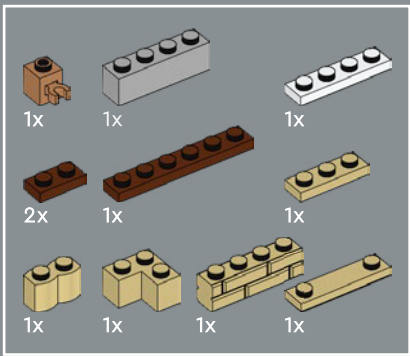

426 1

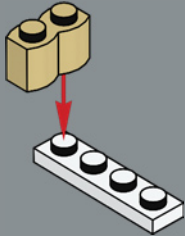

2

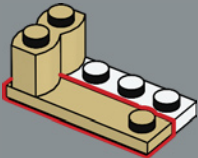

3

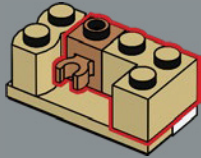

4

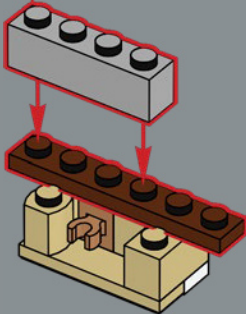

5

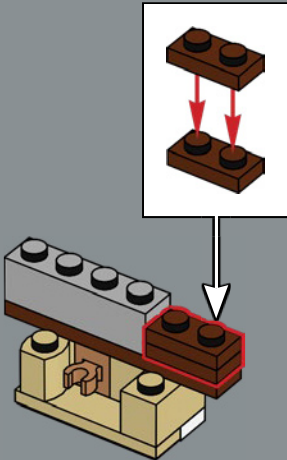

6

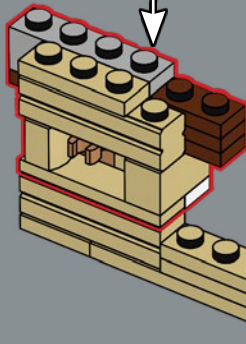
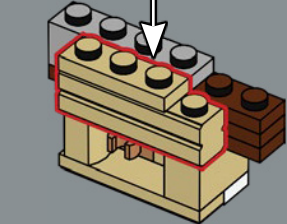
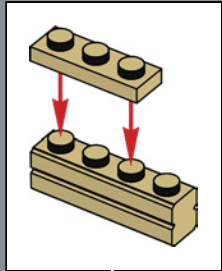

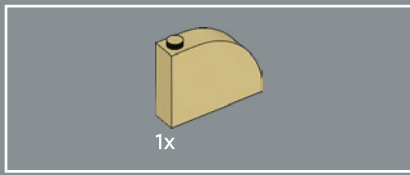

427

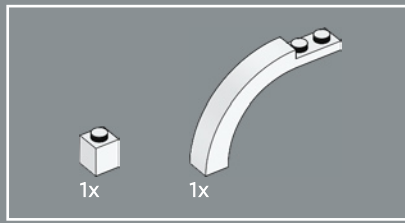
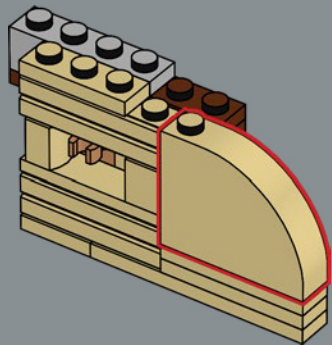

428

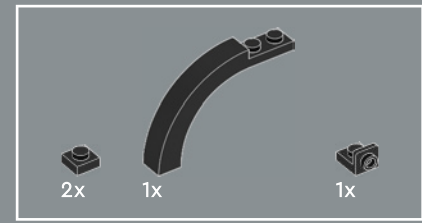
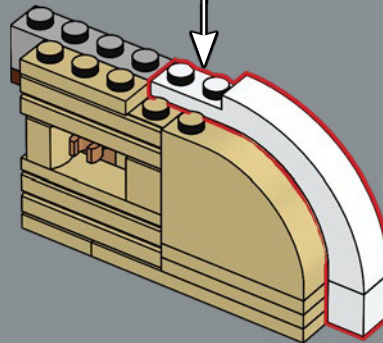
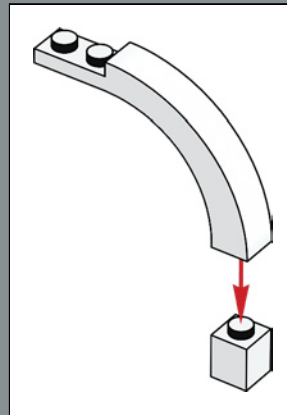

429

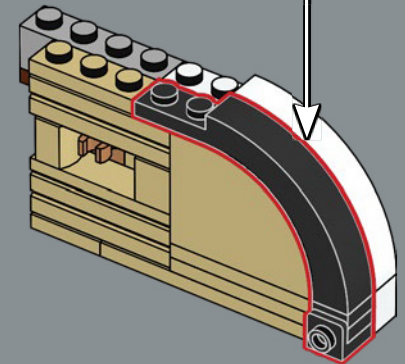
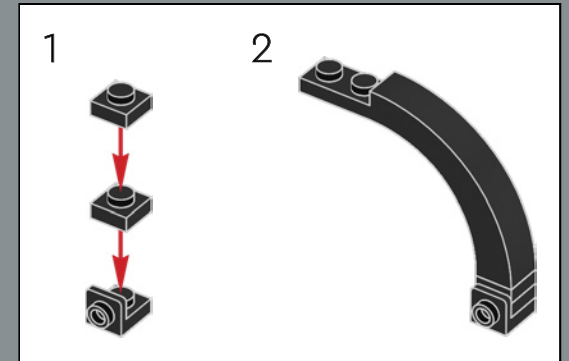

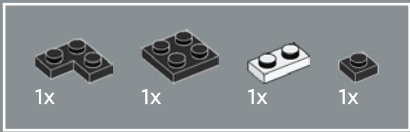

430

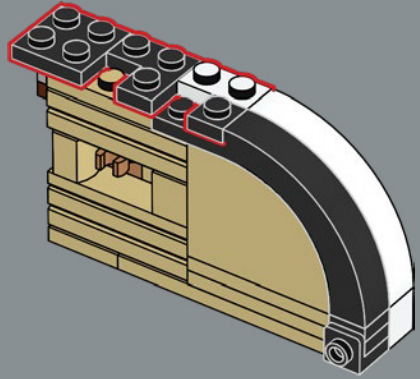

431

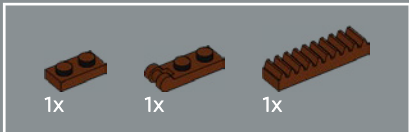
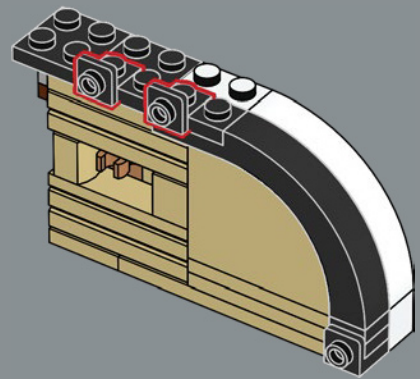

432

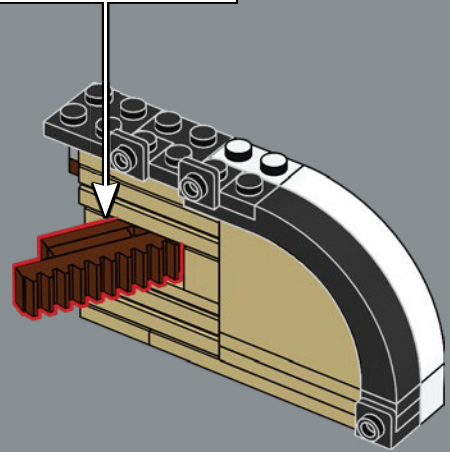
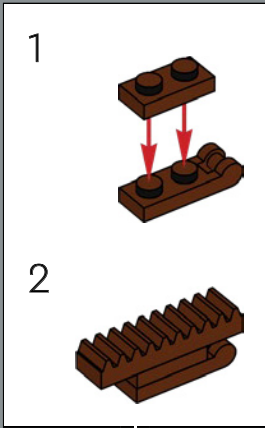

433

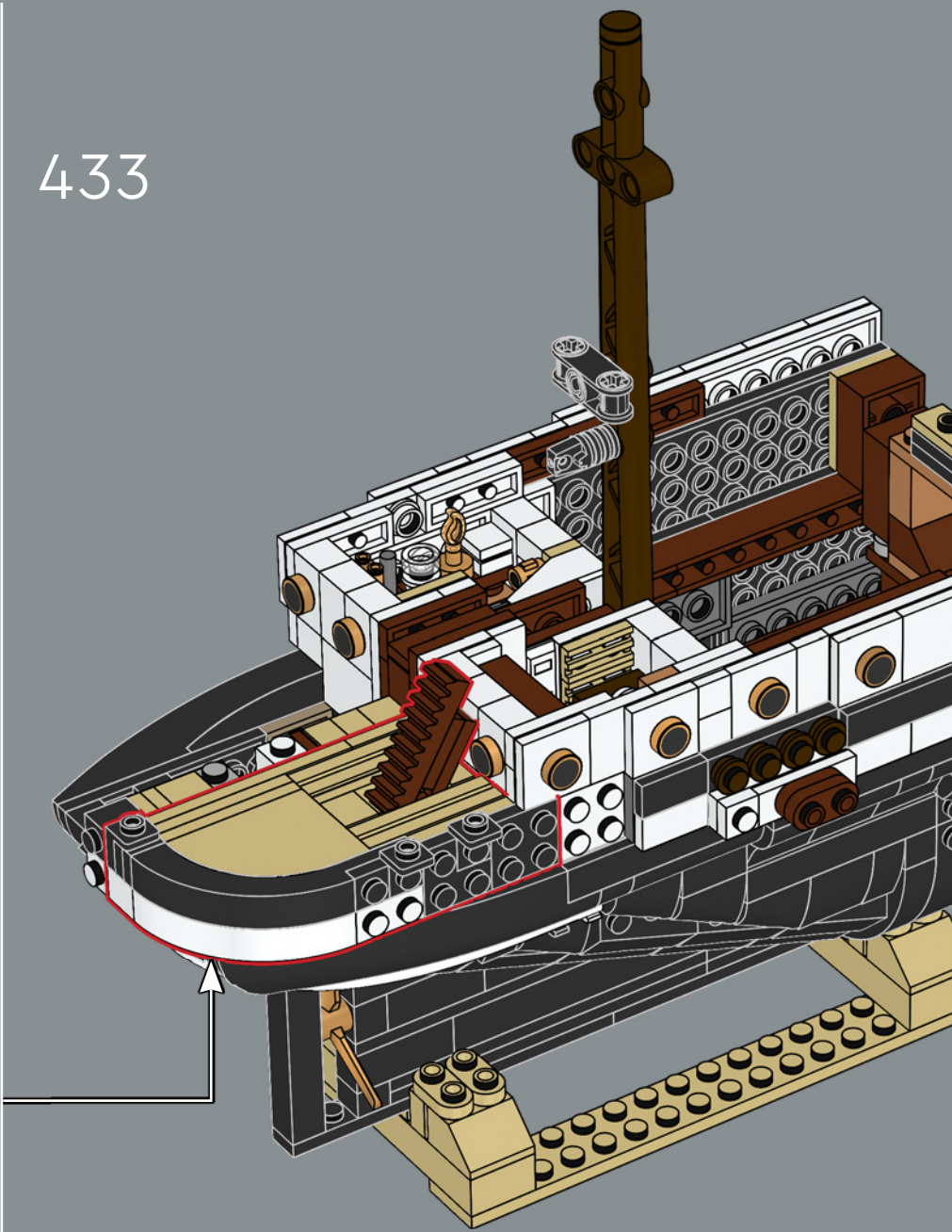

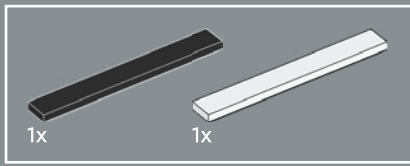

434

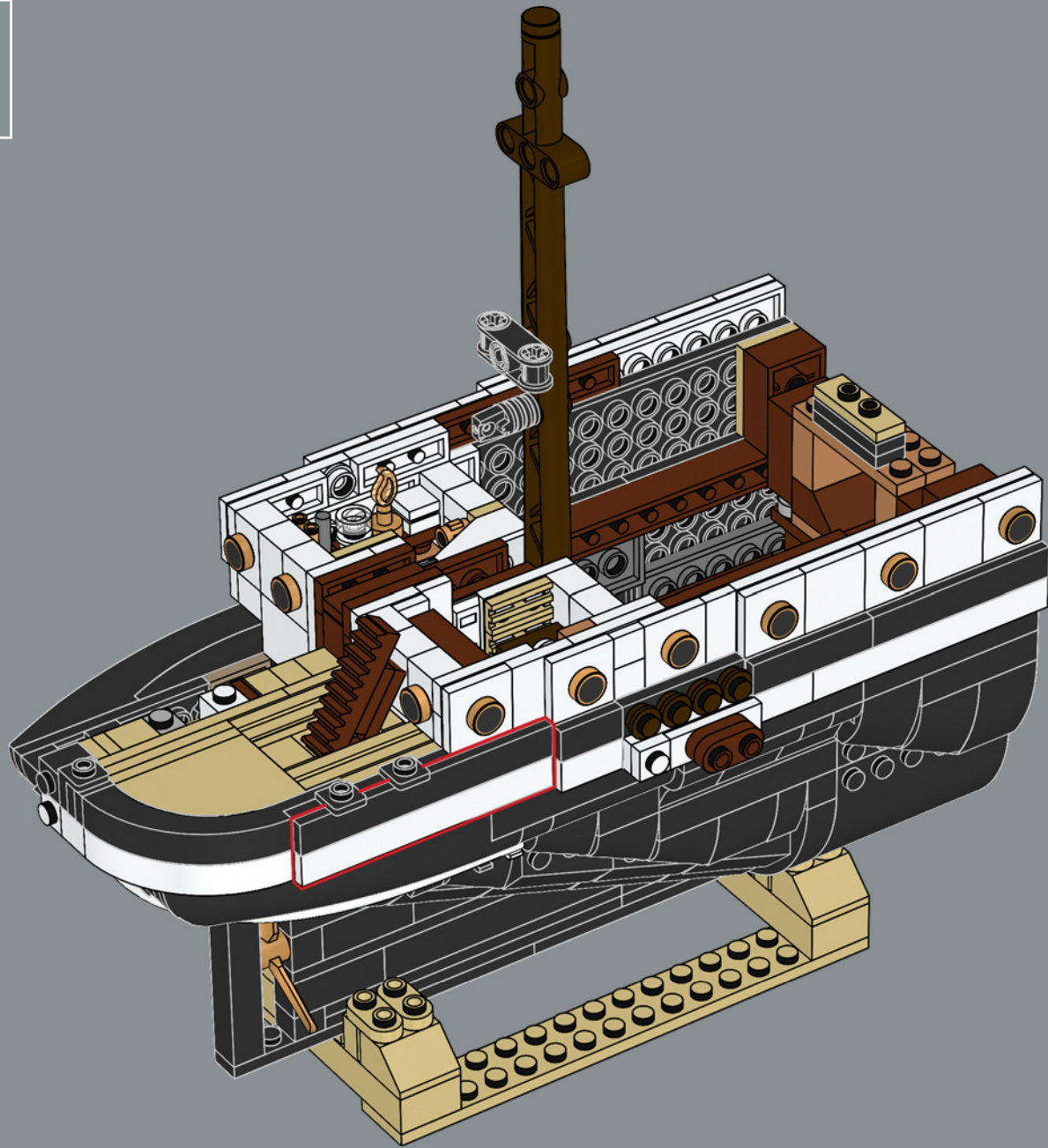

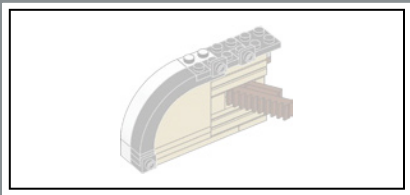

435

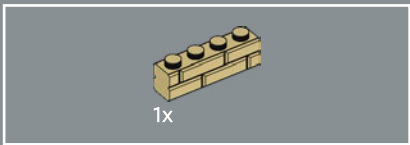
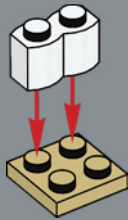

436

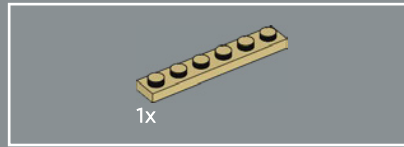
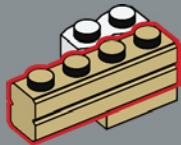

437

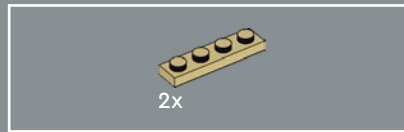
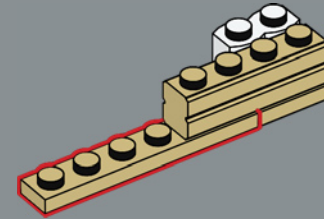

438

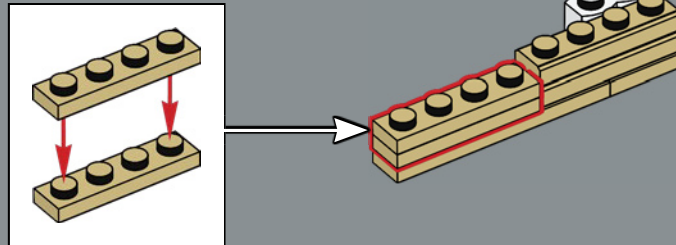

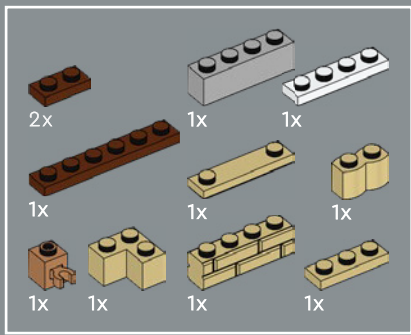

439

1

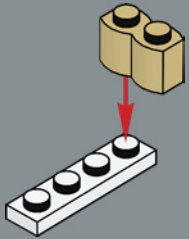

2

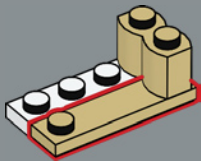

3

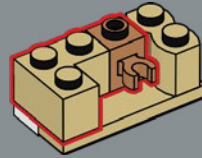

4

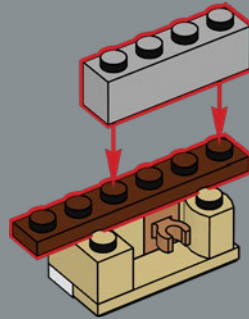

5

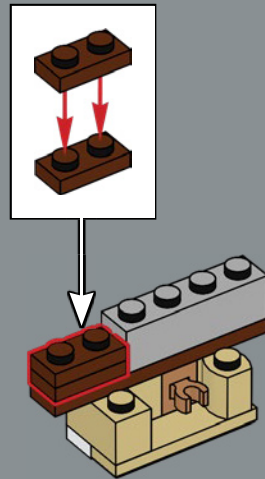

6

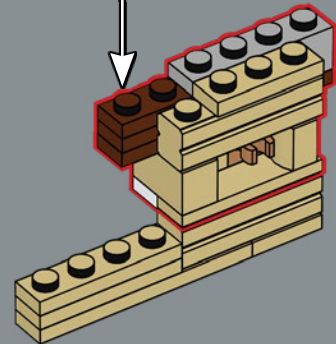
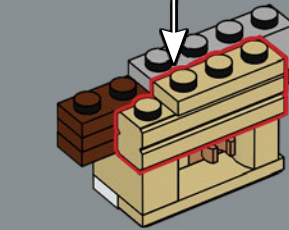
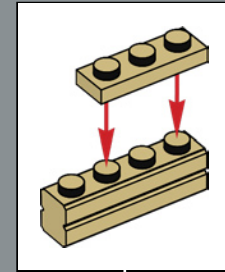

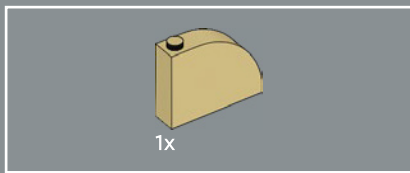

440

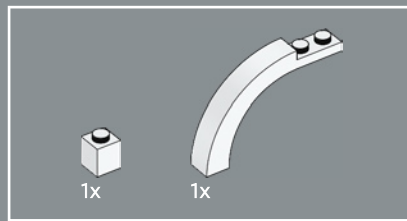
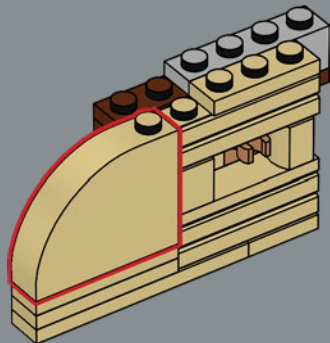

441

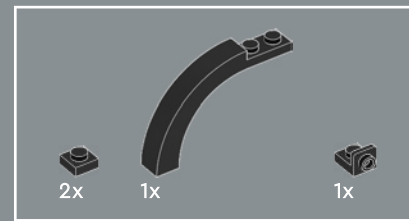
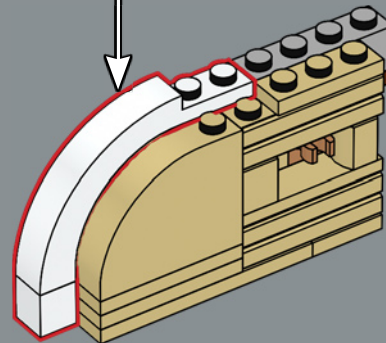
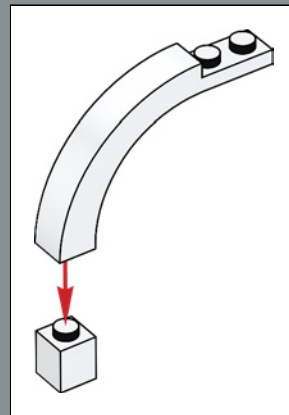

442

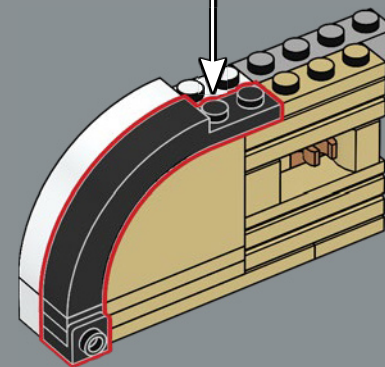
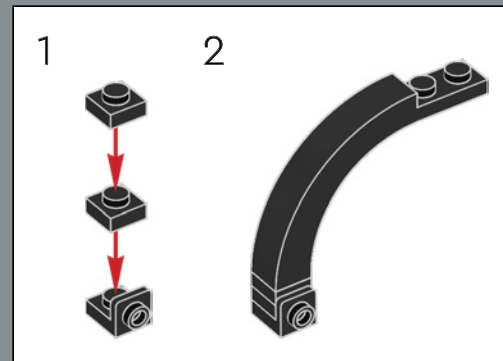

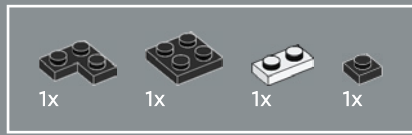

443

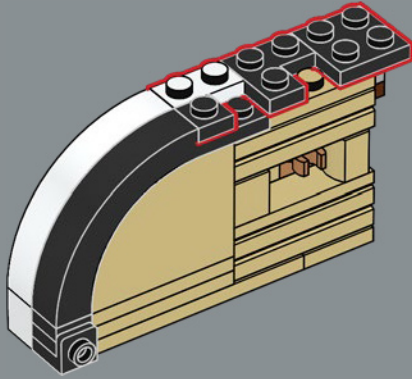

444

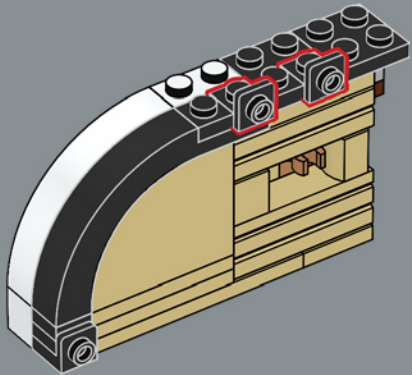

445

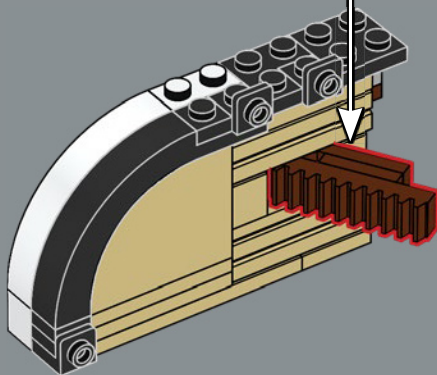
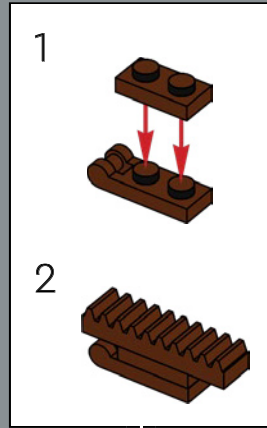

446

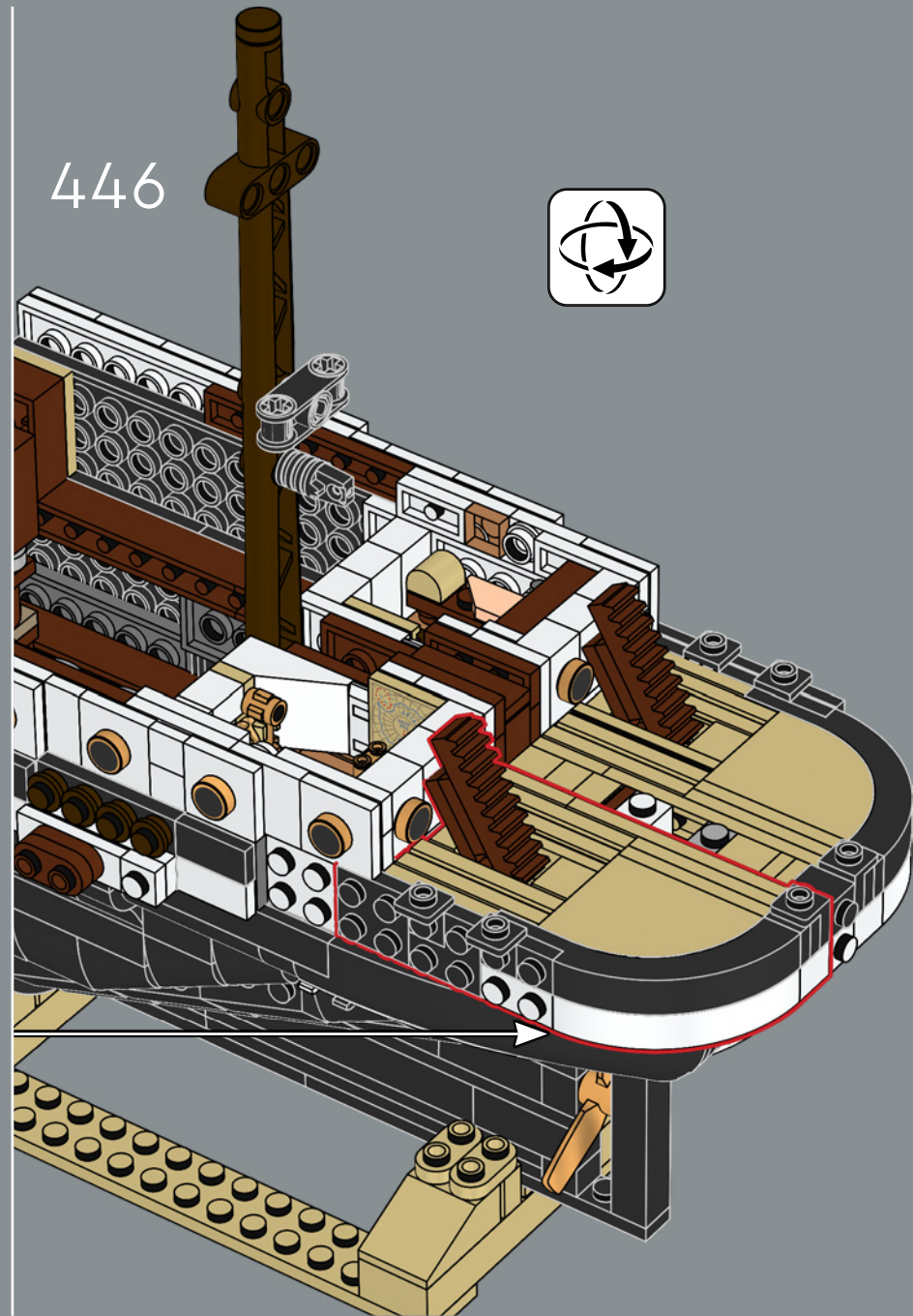

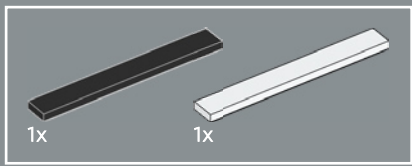

447

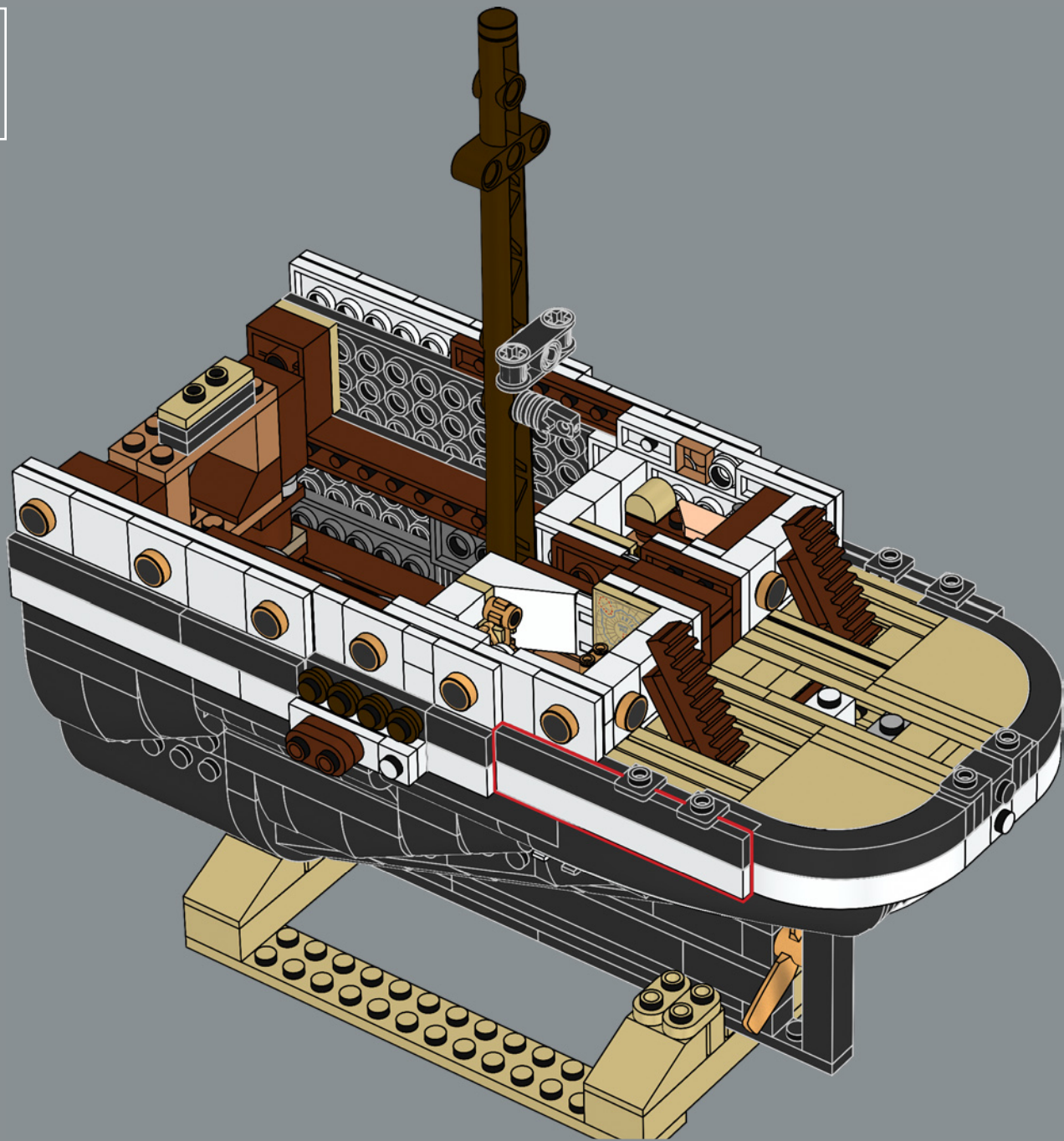

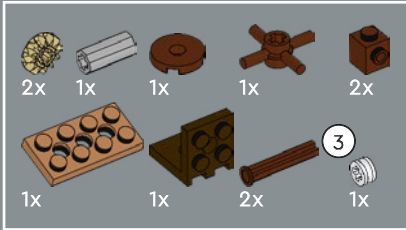
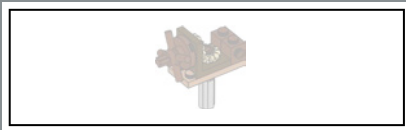

448

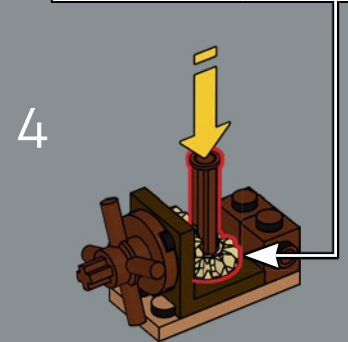
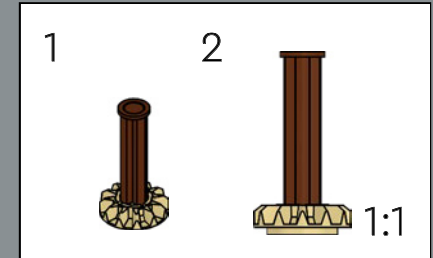
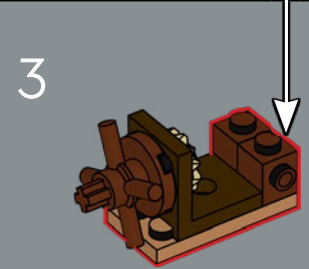
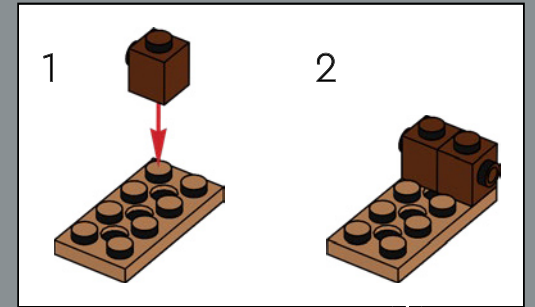
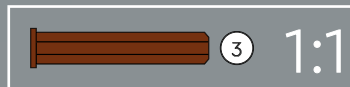
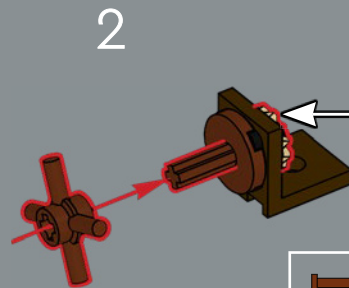
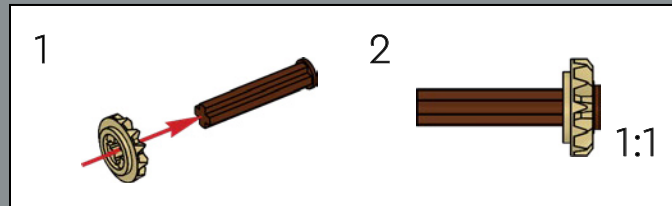
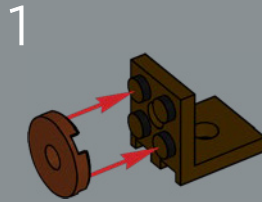

5

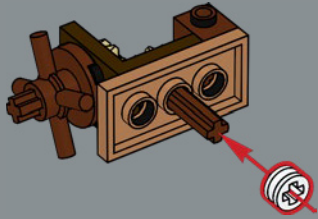

6

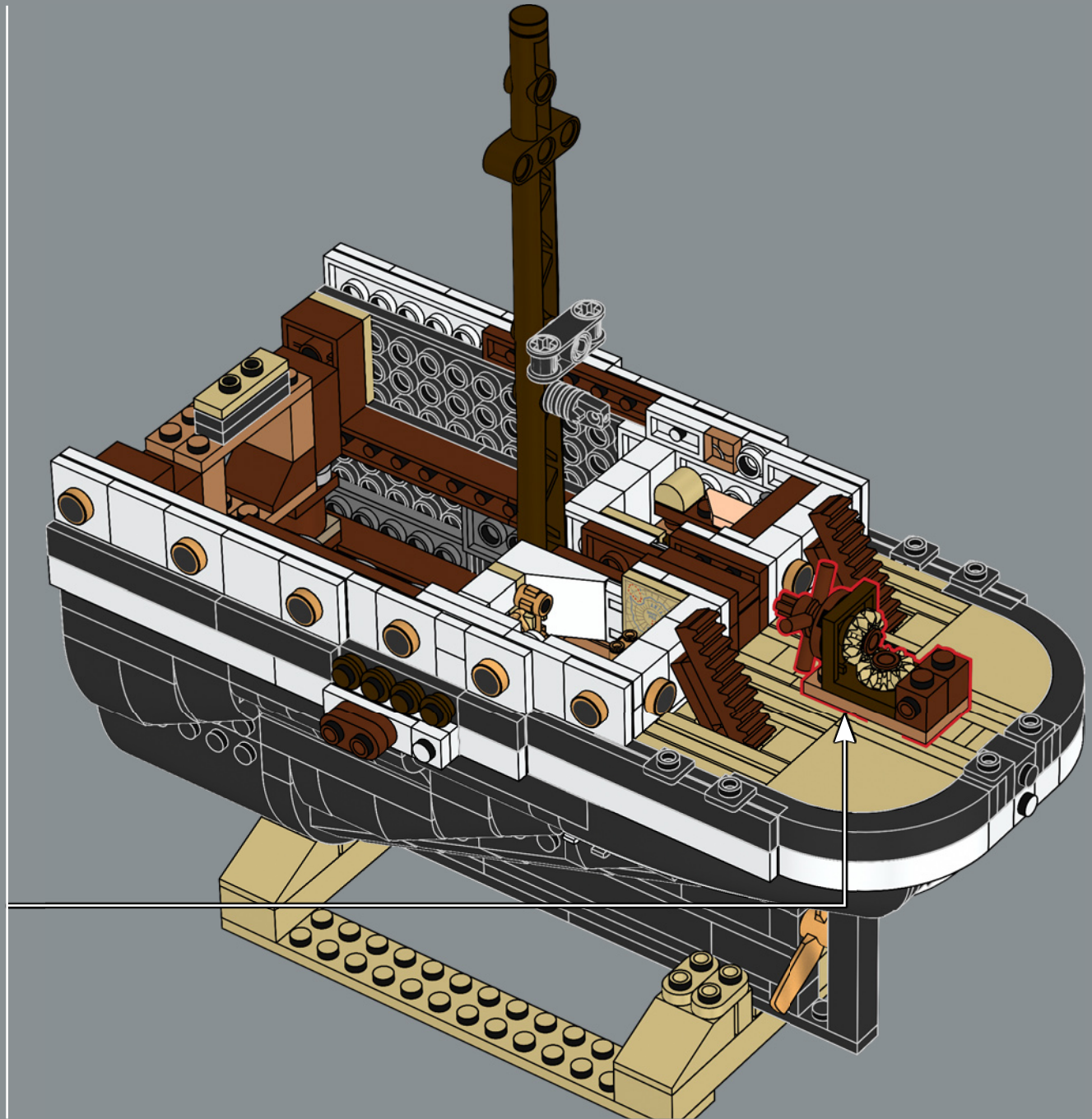
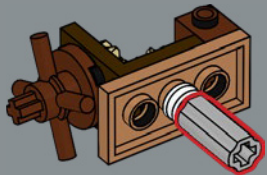

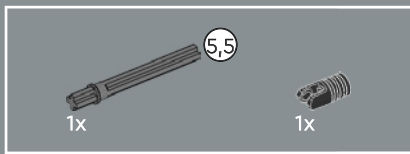

449

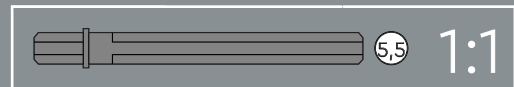
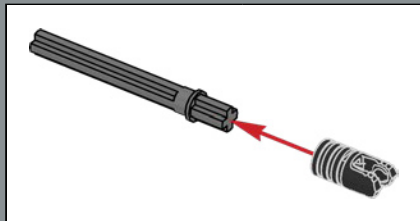
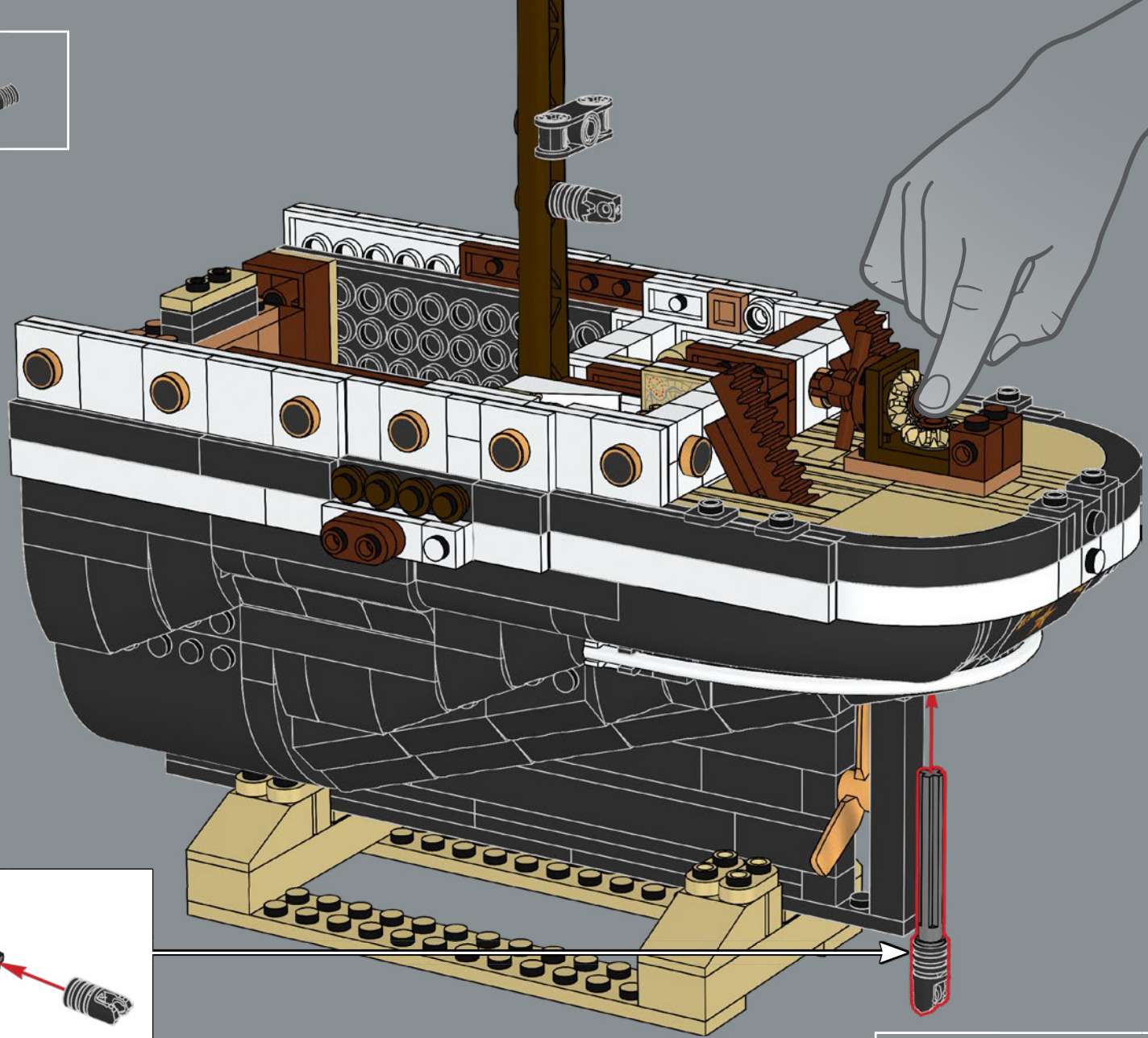

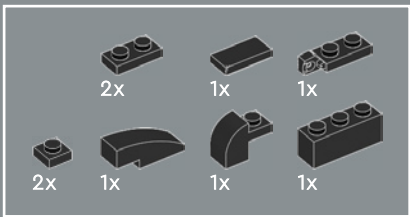

450

1

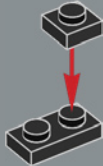

2

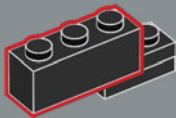

3

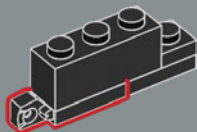

4

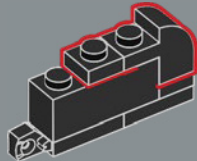

5

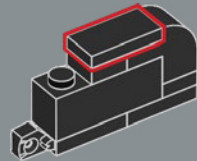

6

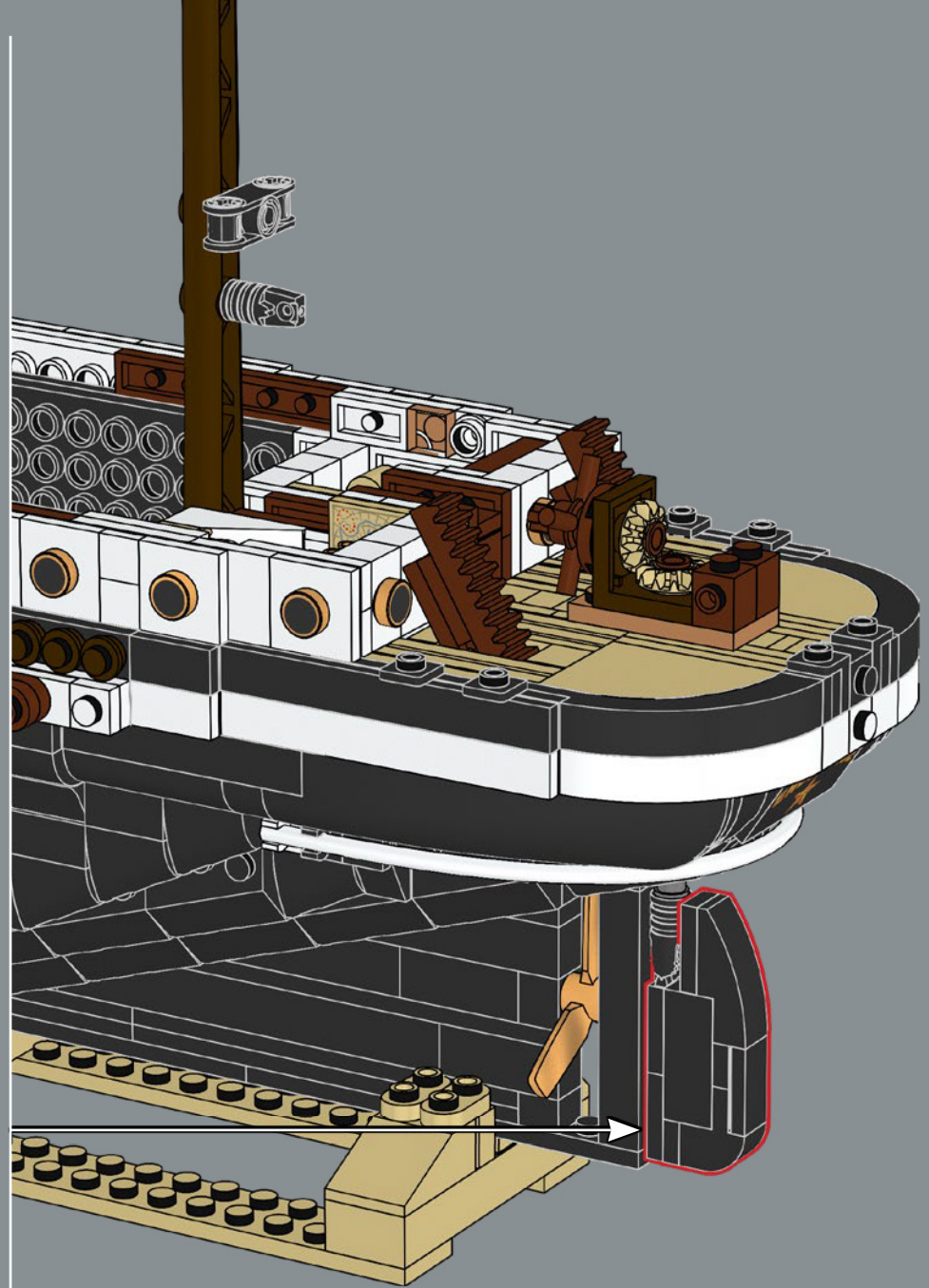
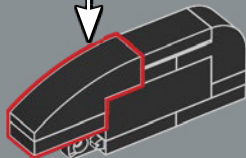
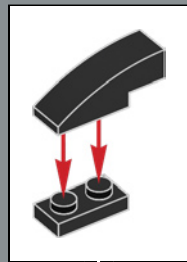

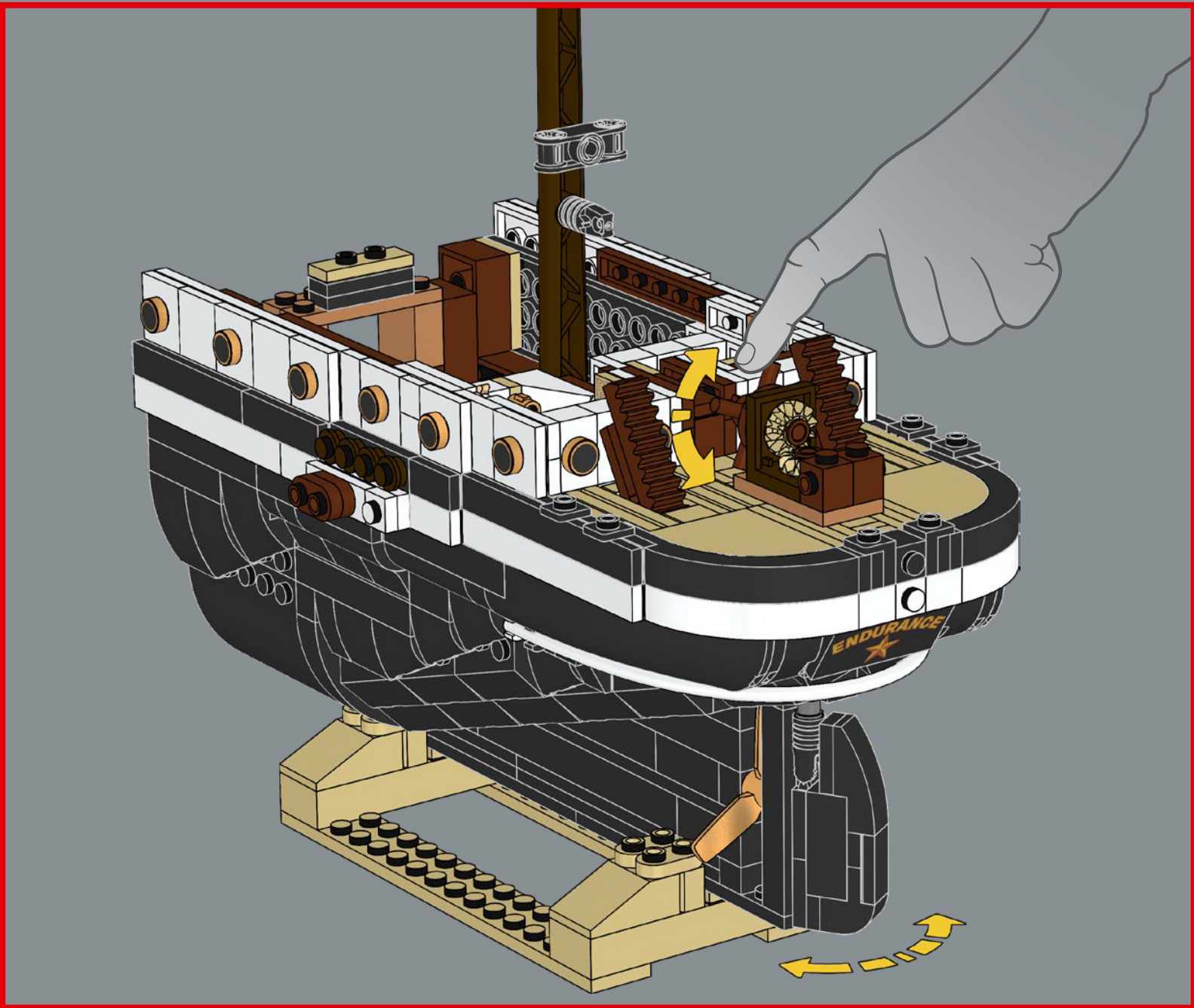

2x

451

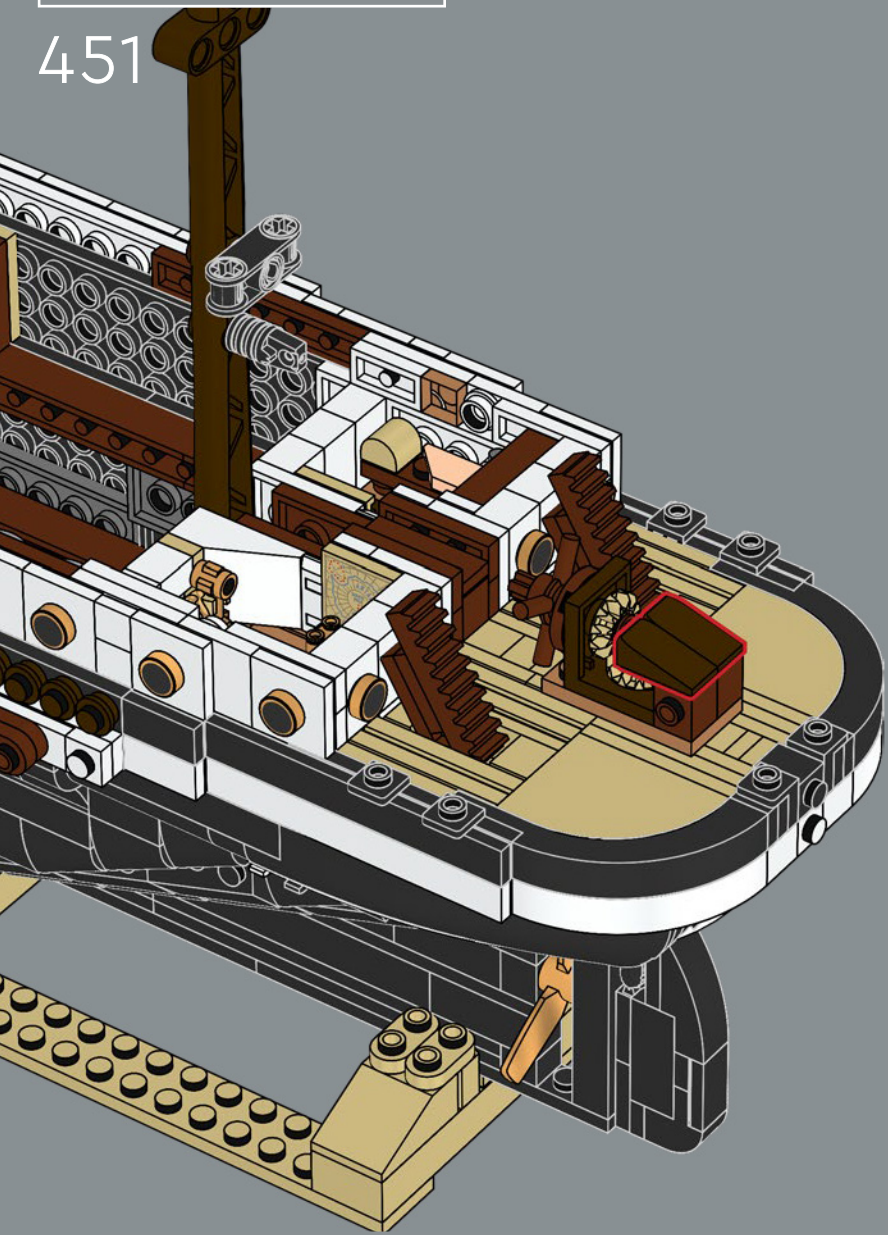

1x

1x

452

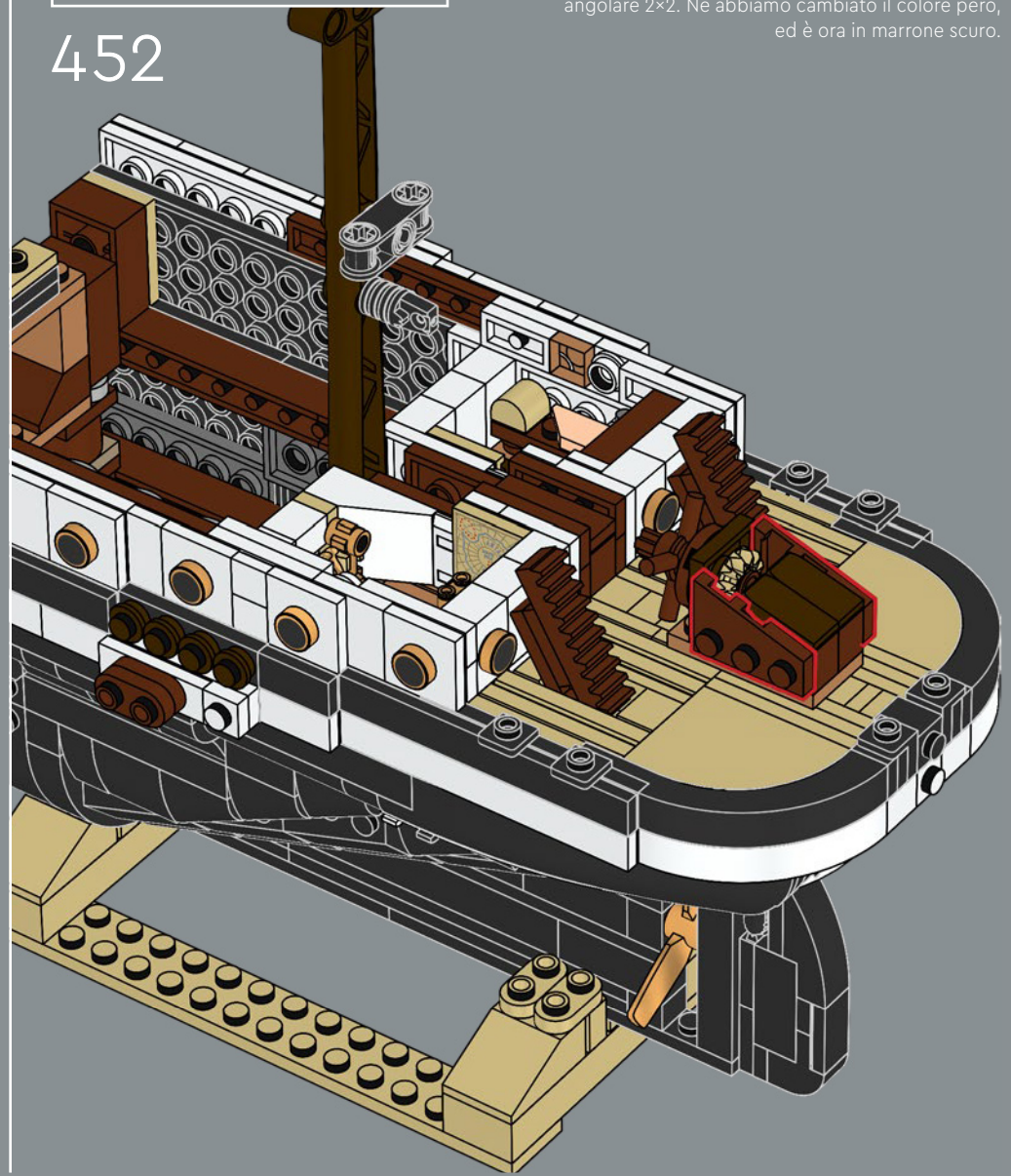

★
Per la cabina di pilotaggio che controlla il timone, abbiamo progettato una delle scatole di ingranaggi LEGO® più piccoli di sempre con un'originale piastra angolare 2x2. Ne abbiamo cambiato il colore però, ed è ora in marrone scuro.



6x

453

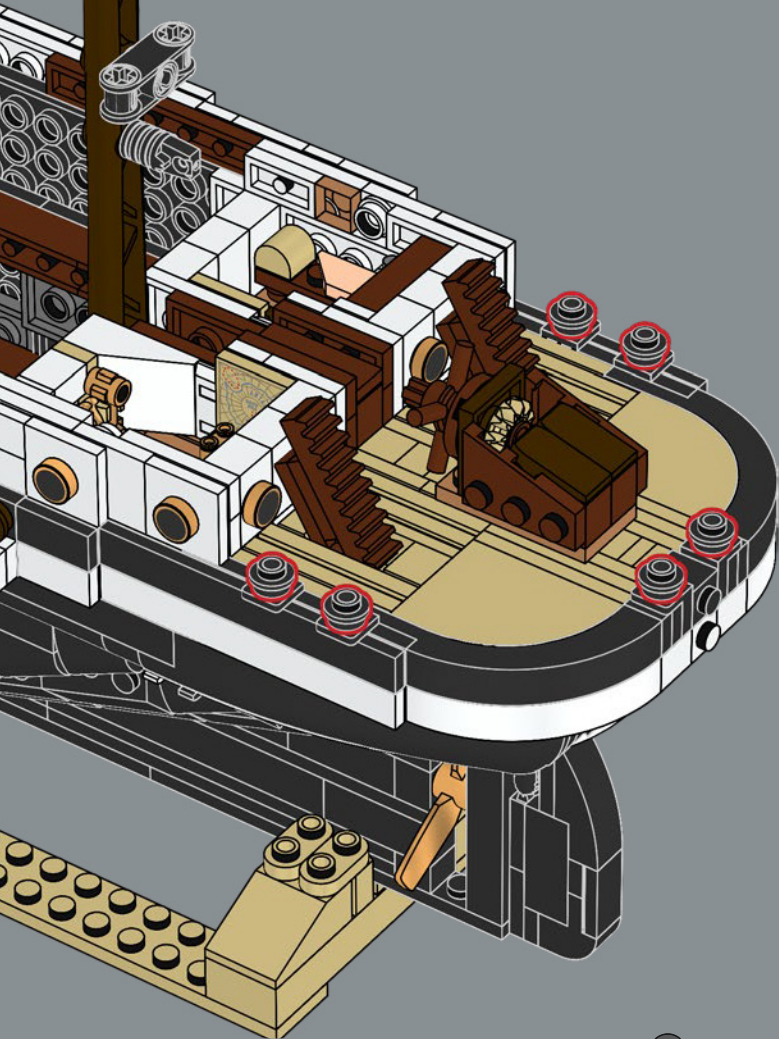

6x

454

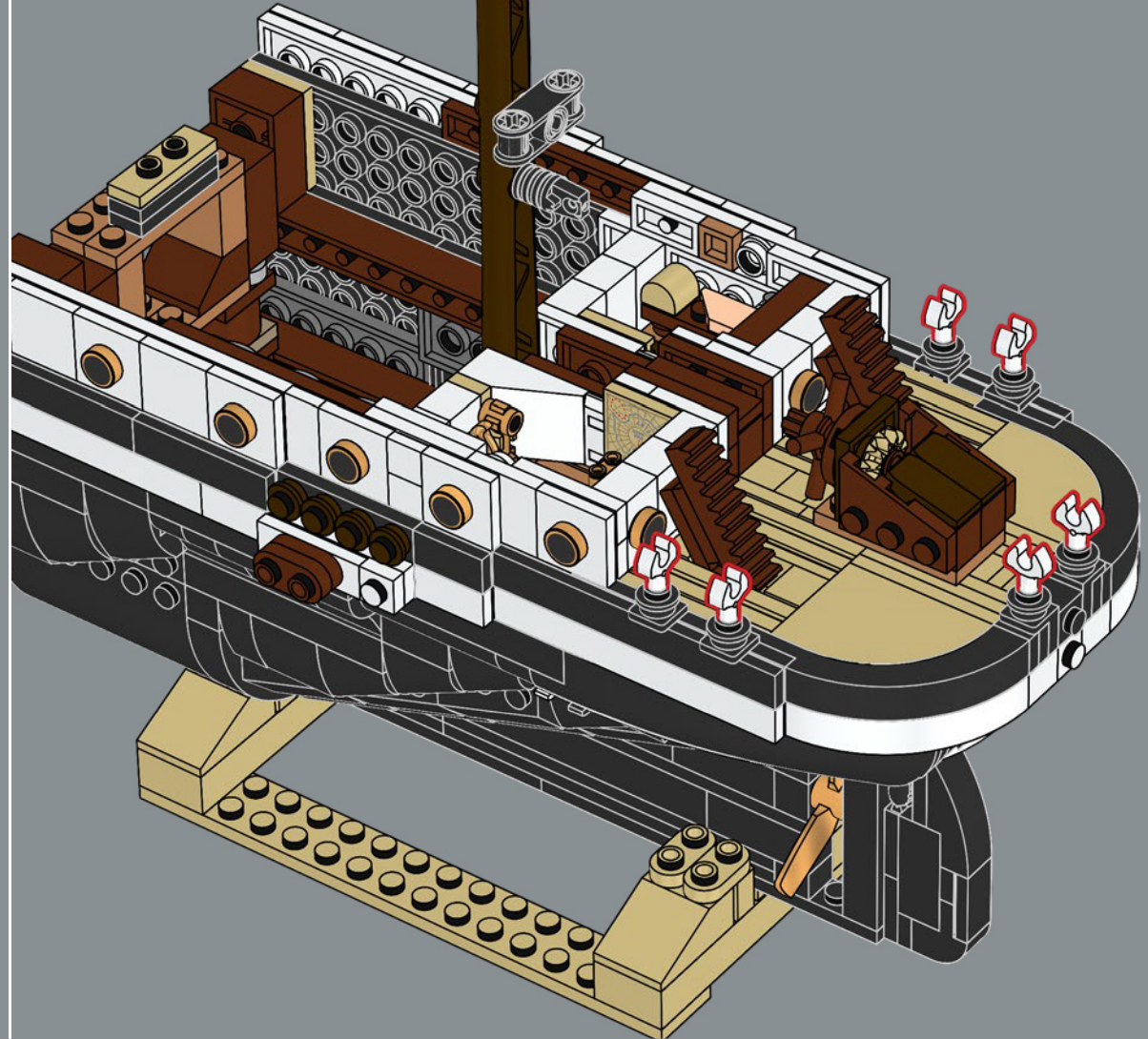

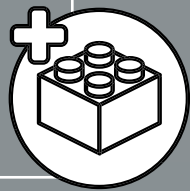
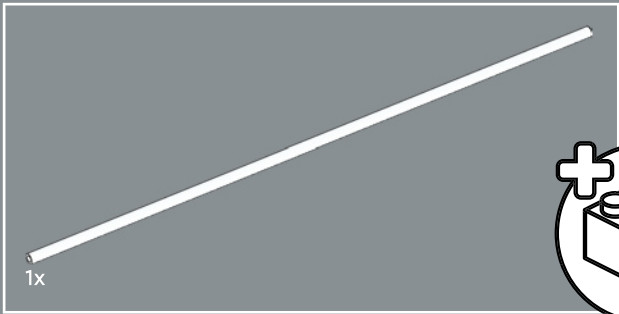

455

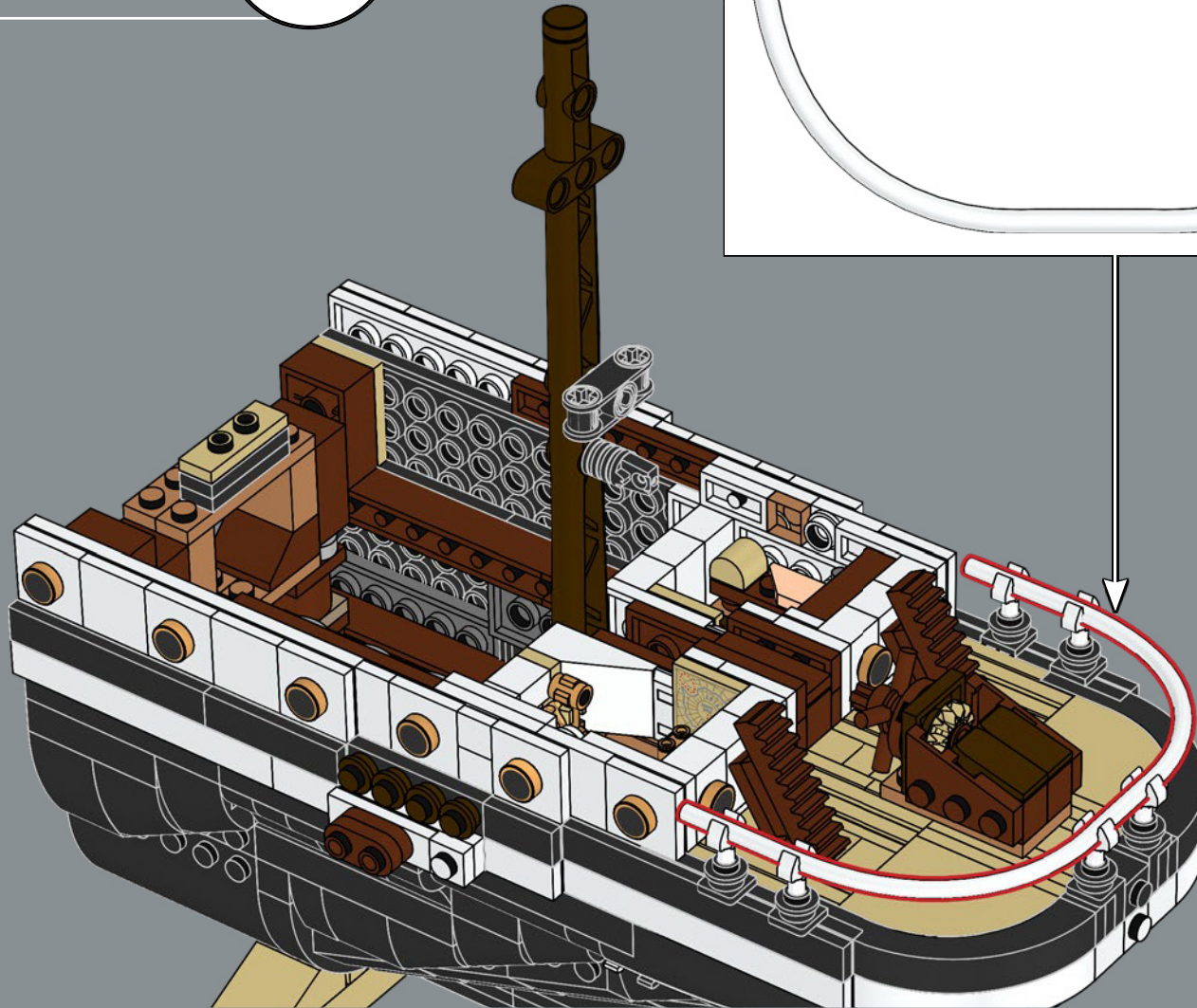
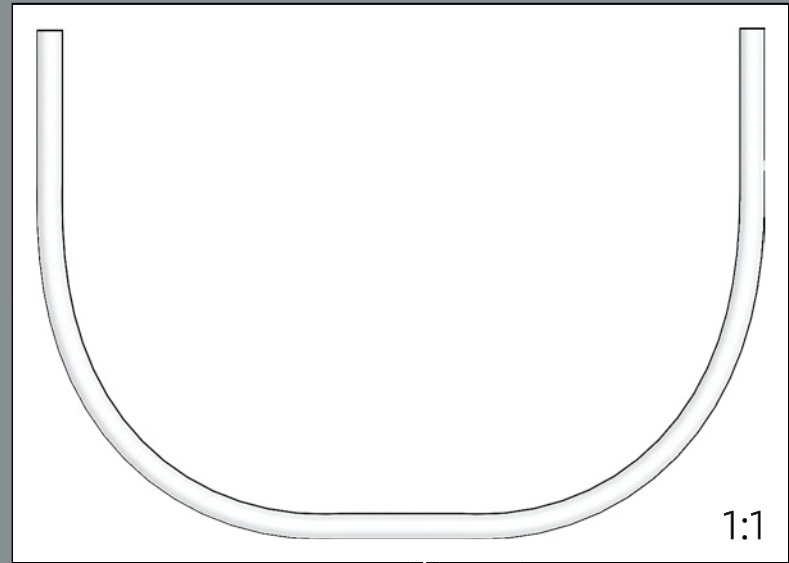



2x

456

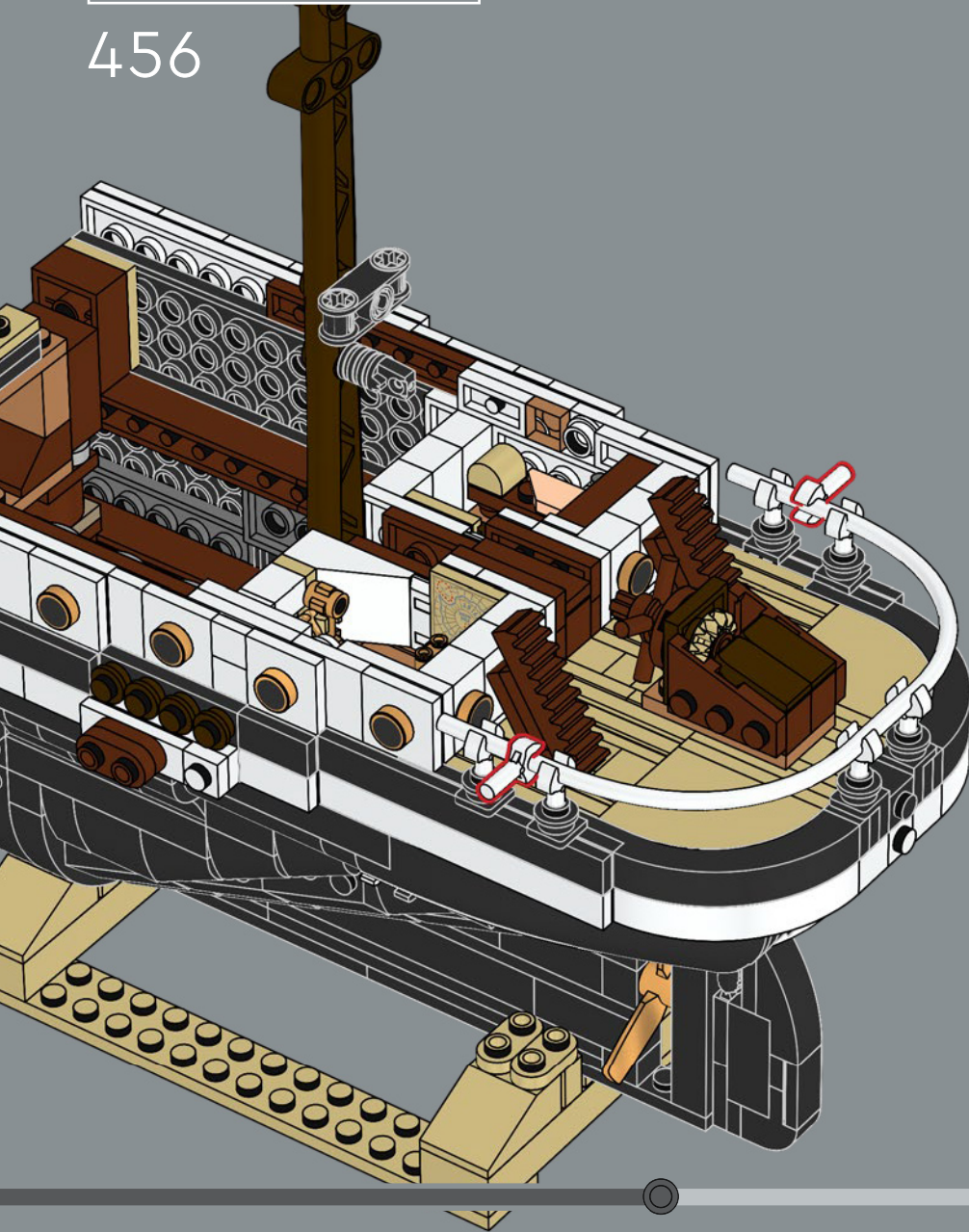

2x

457

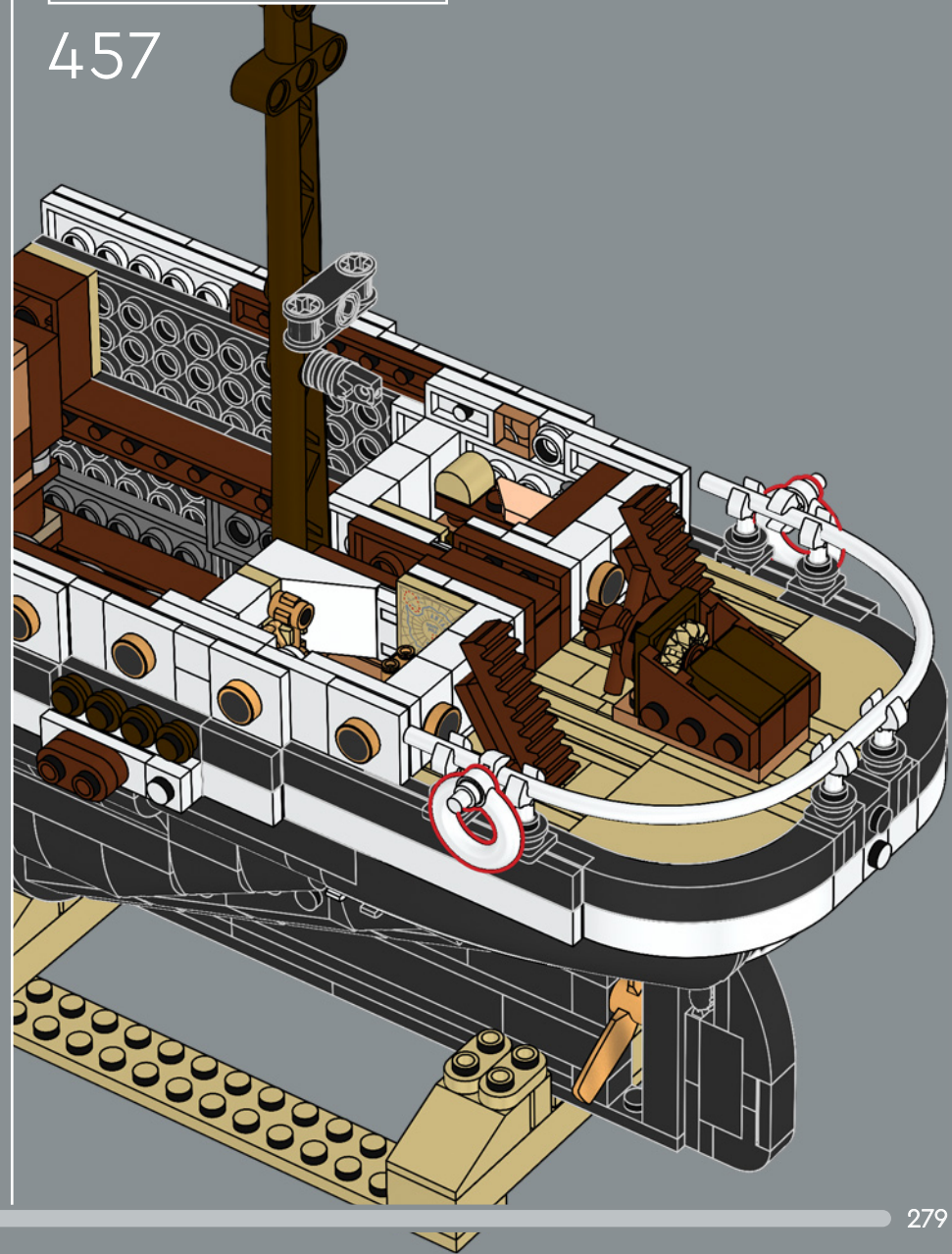

458

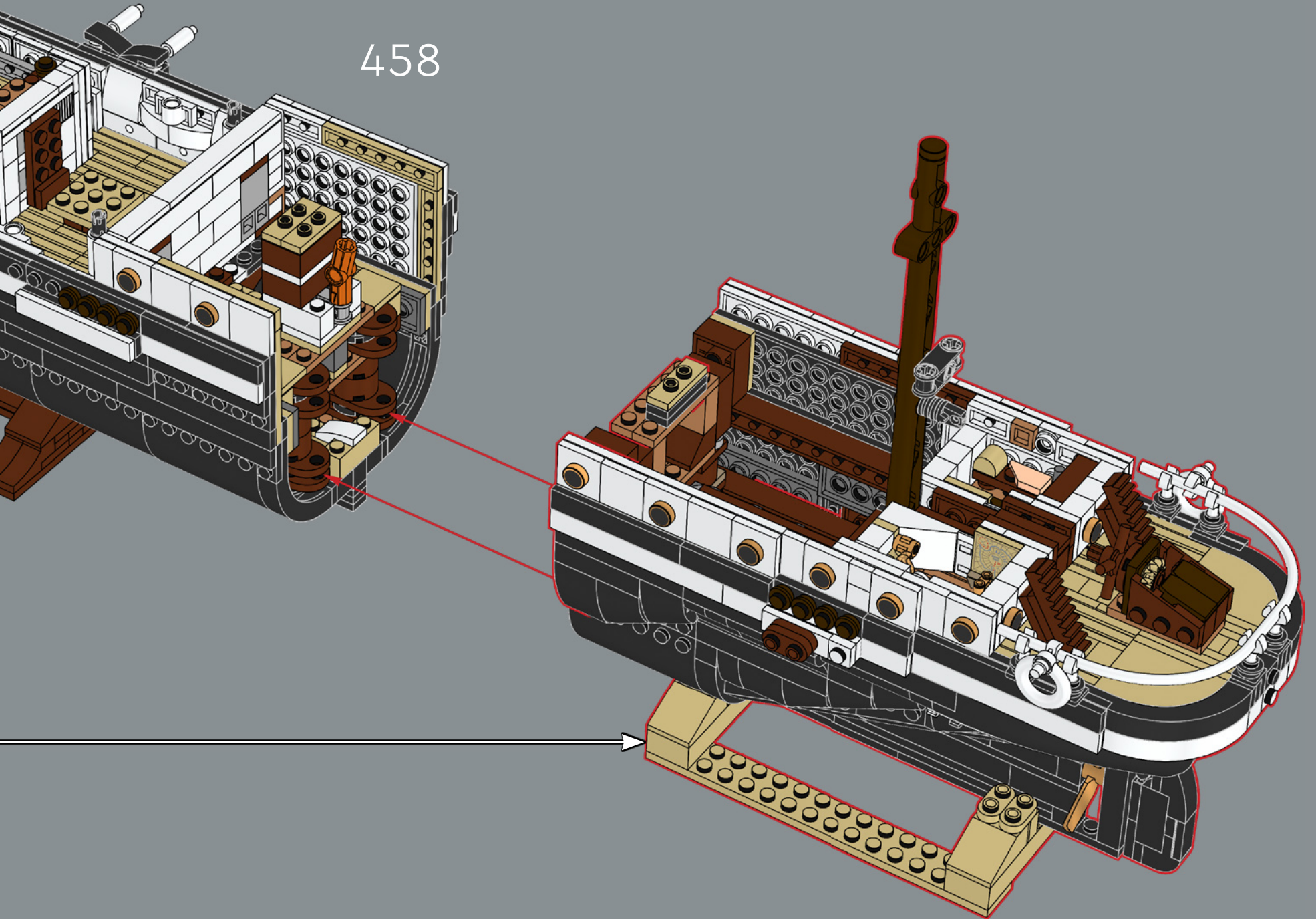

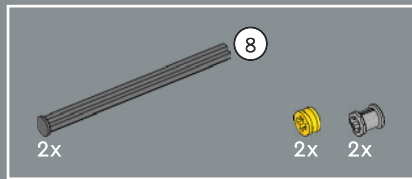

459

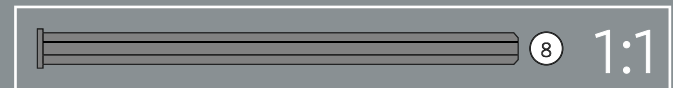
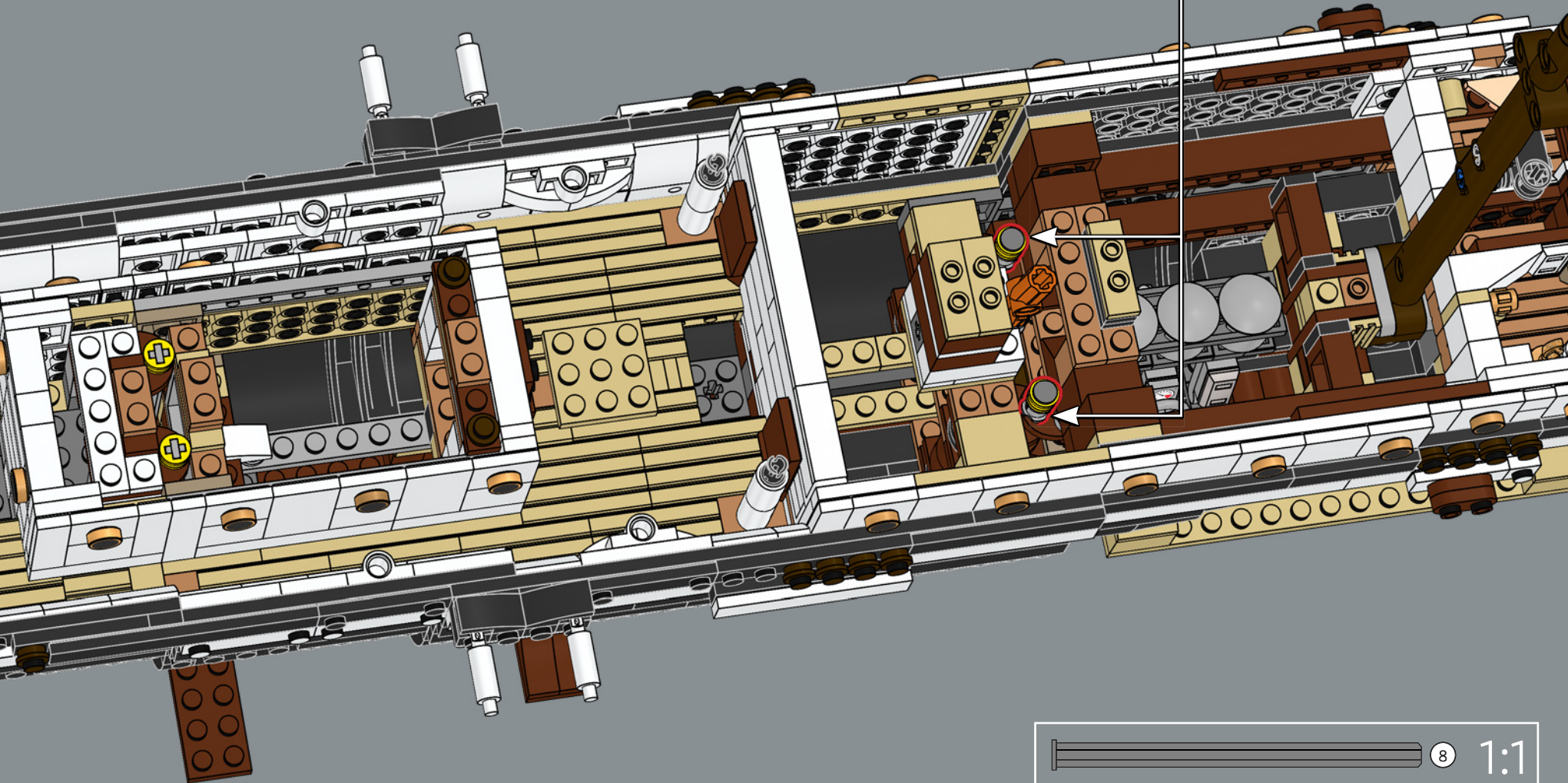
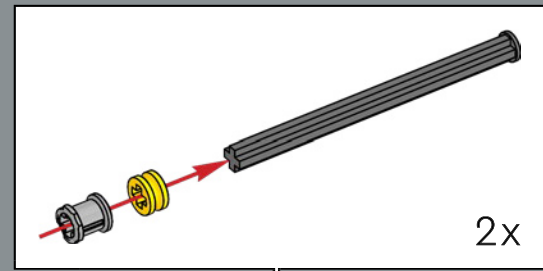

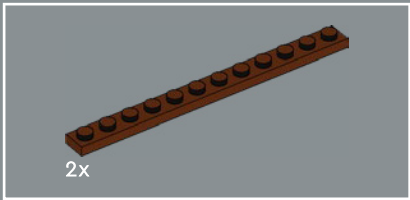

2x

460

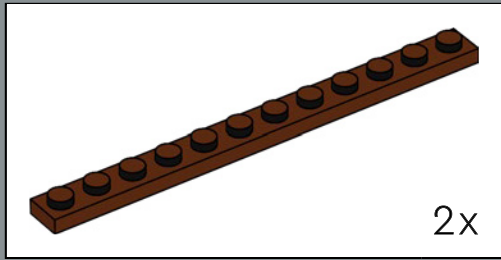

2x

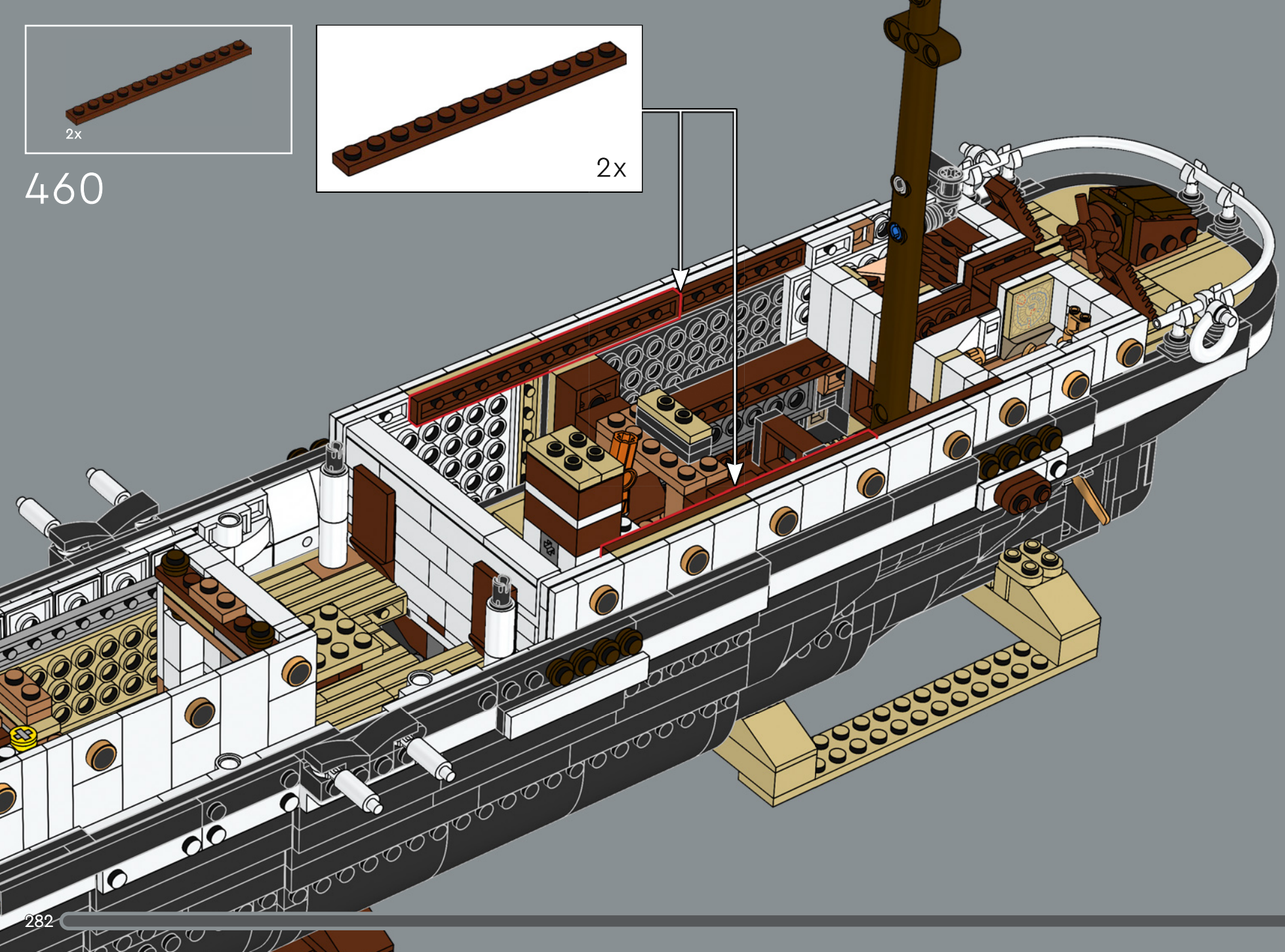

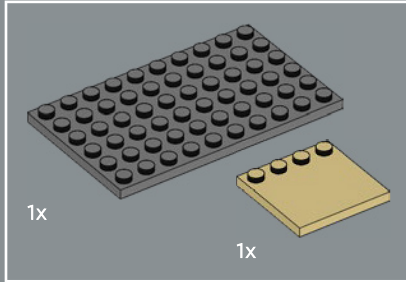
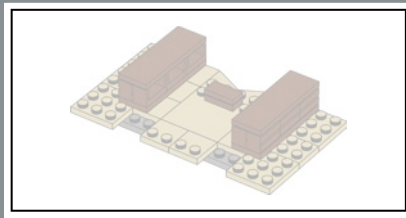

461

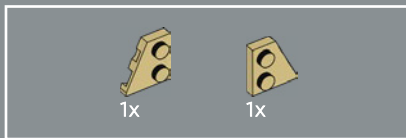
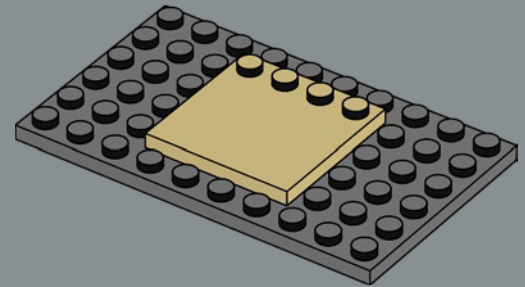

462

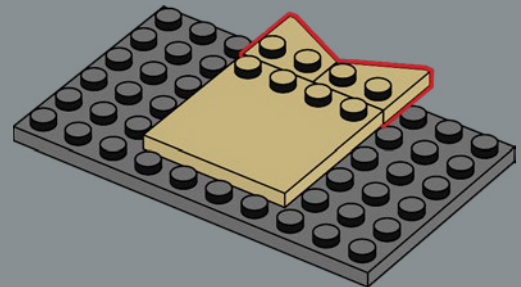

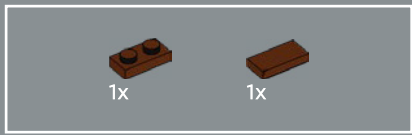

463

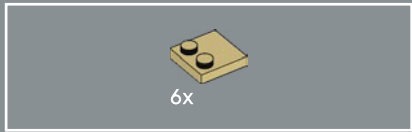
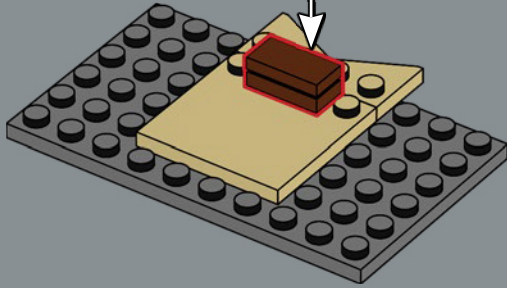
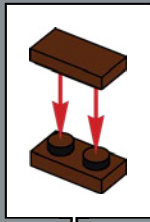

464

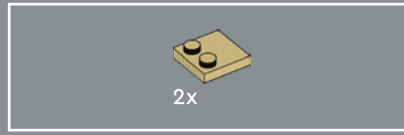
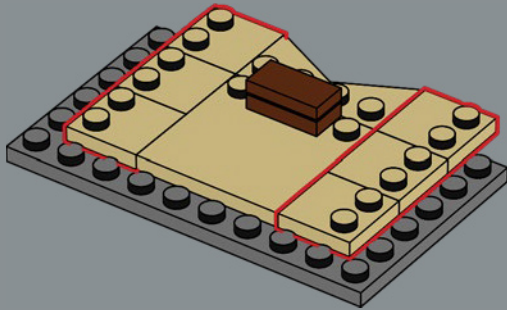

465

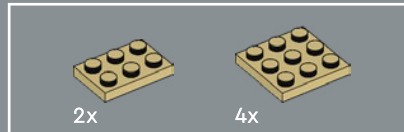
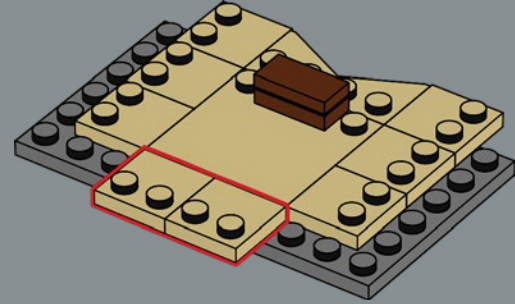

466

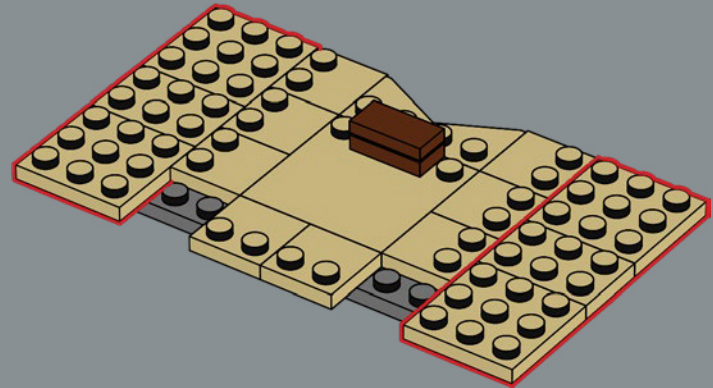

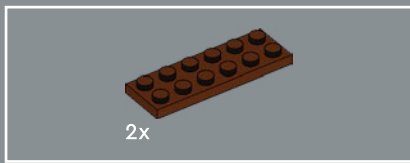

467

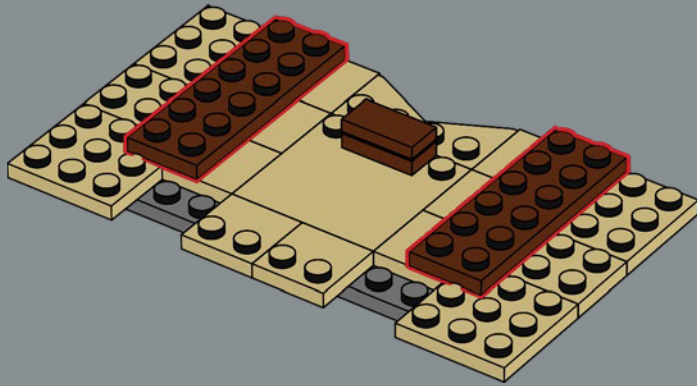

468

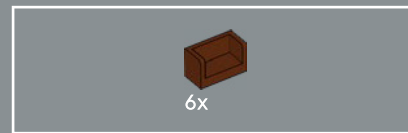
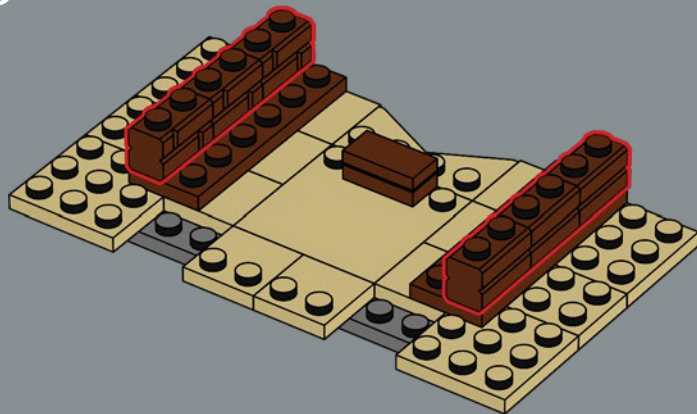

469

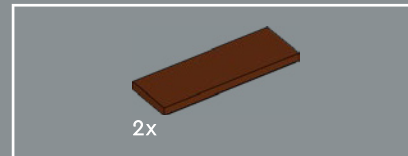
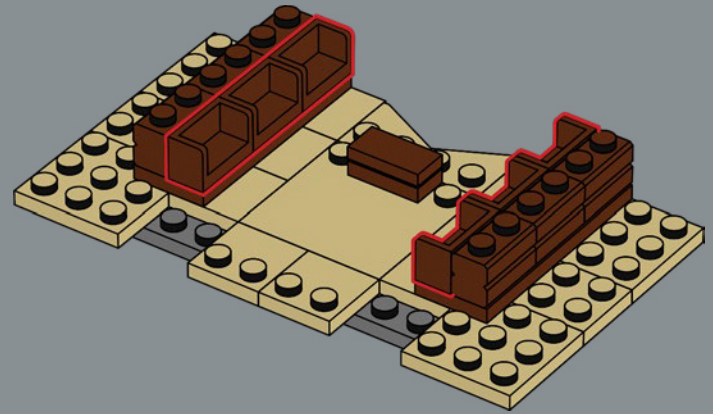

470

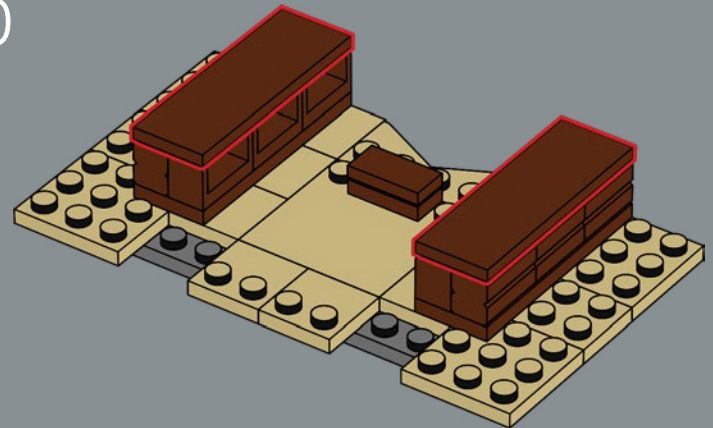

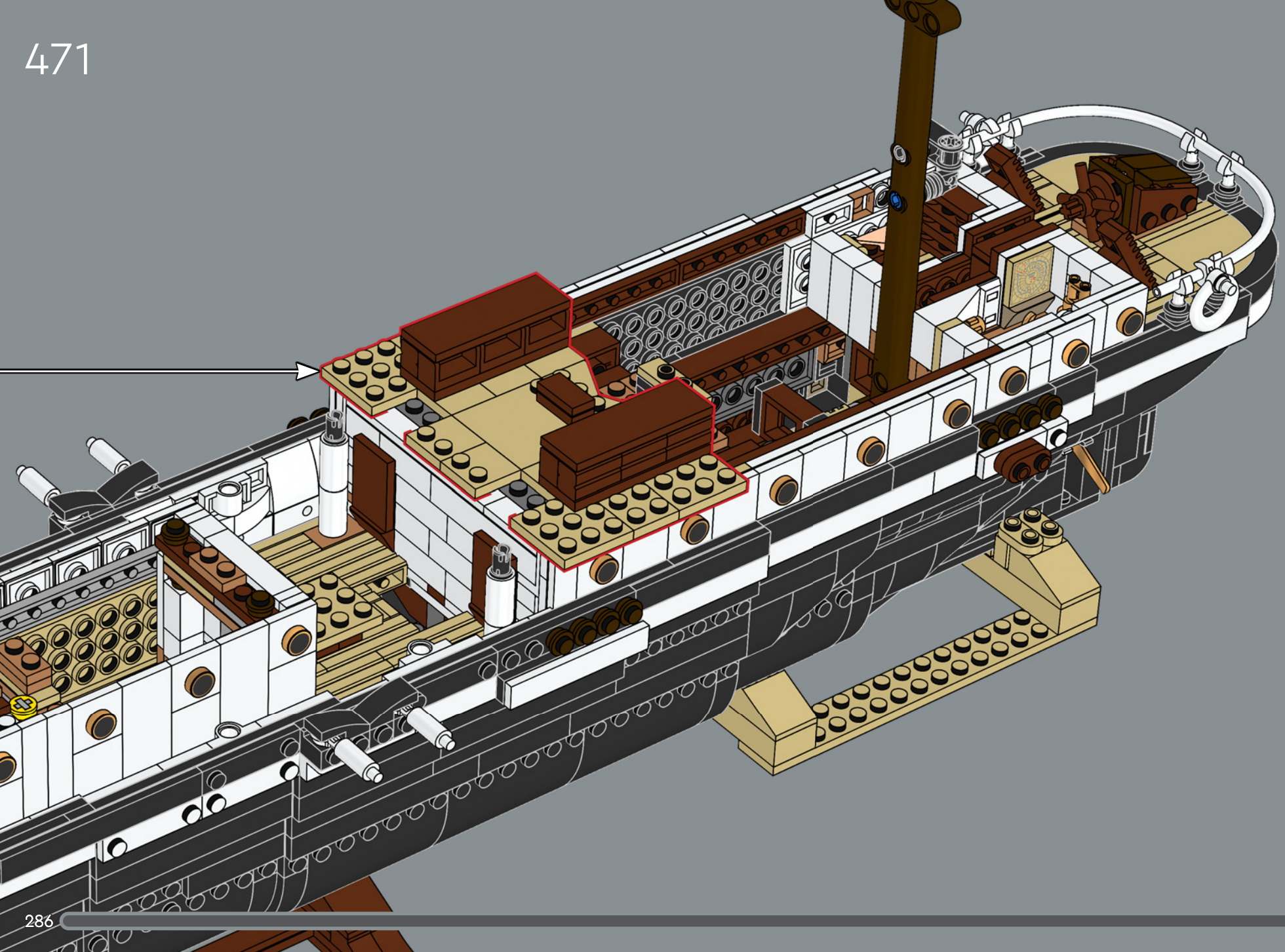

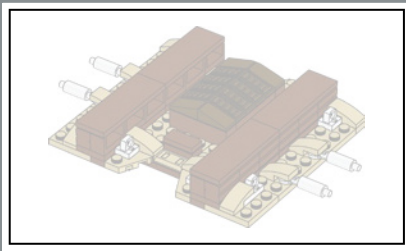

472

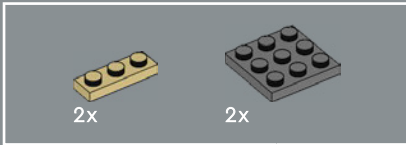
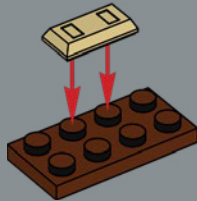

473

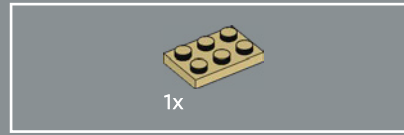
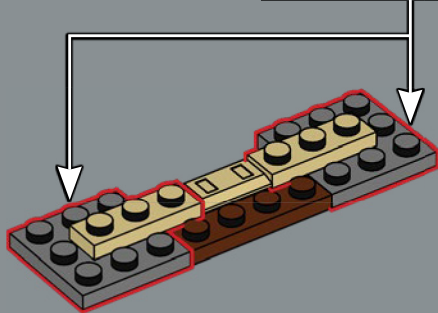
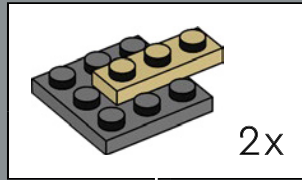

474

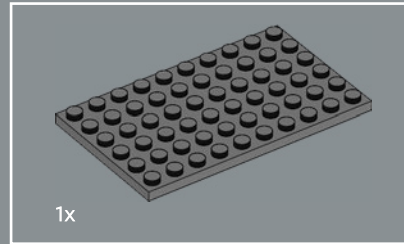
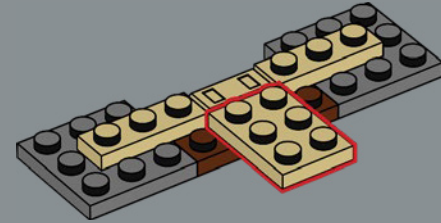

475

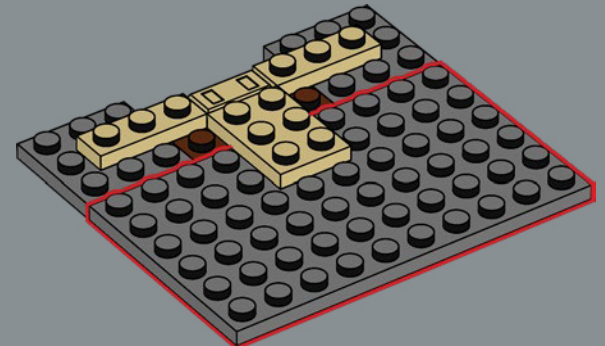

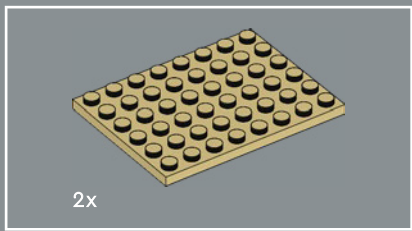

476

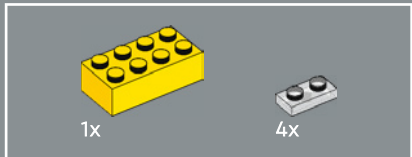
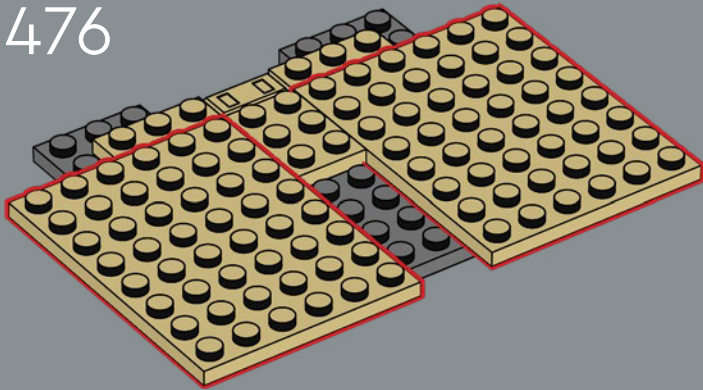

477

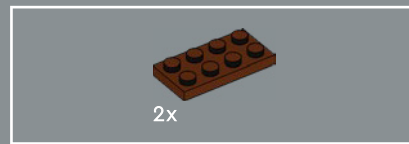
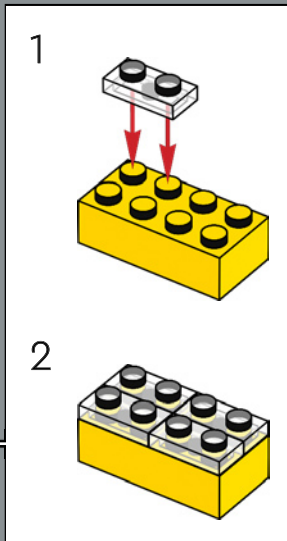
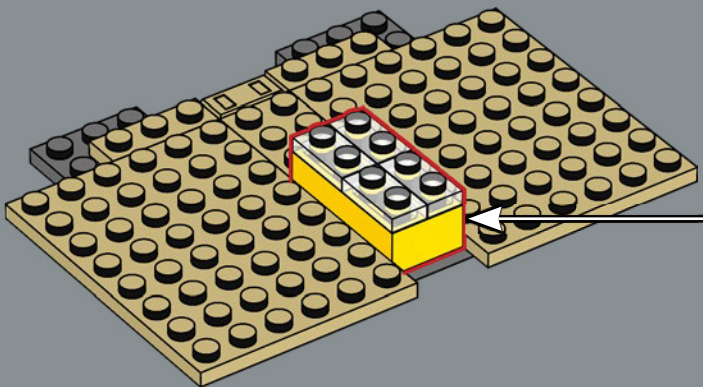

478

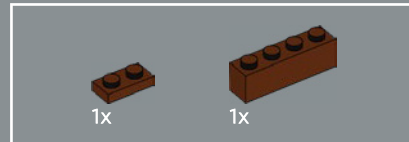
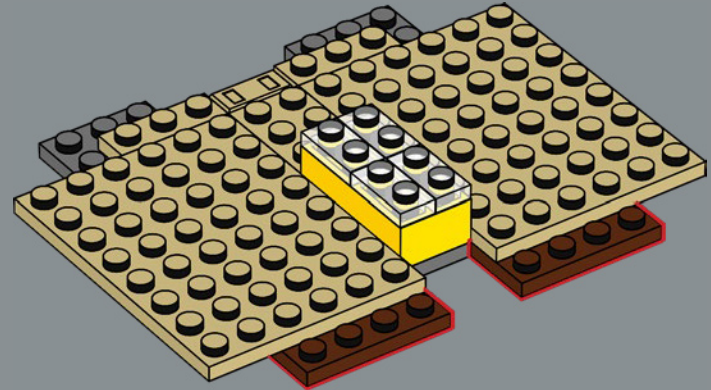

479

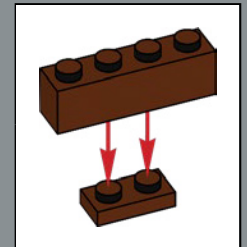
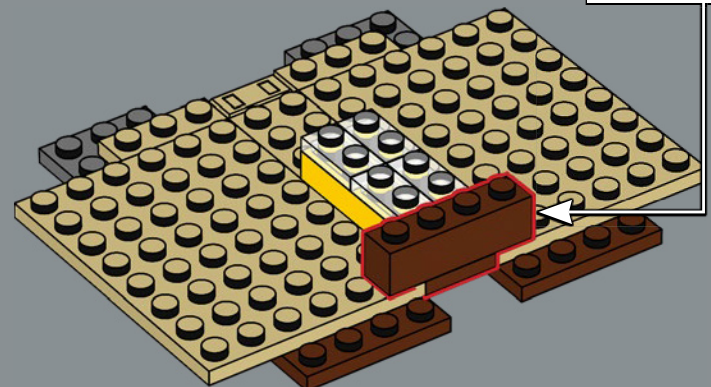

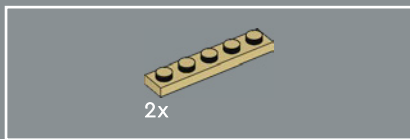

480

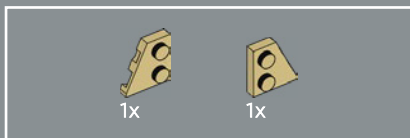
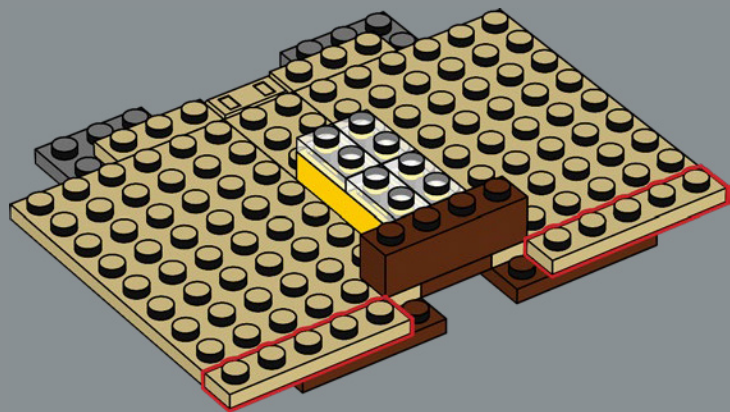

481

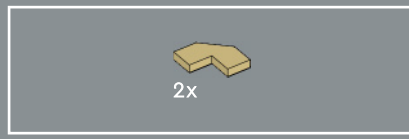
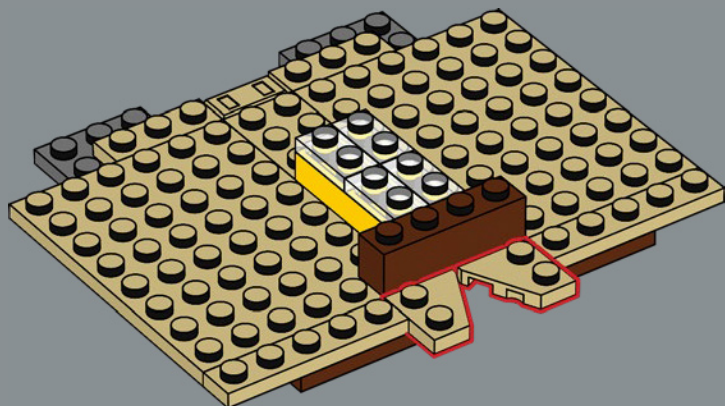

482

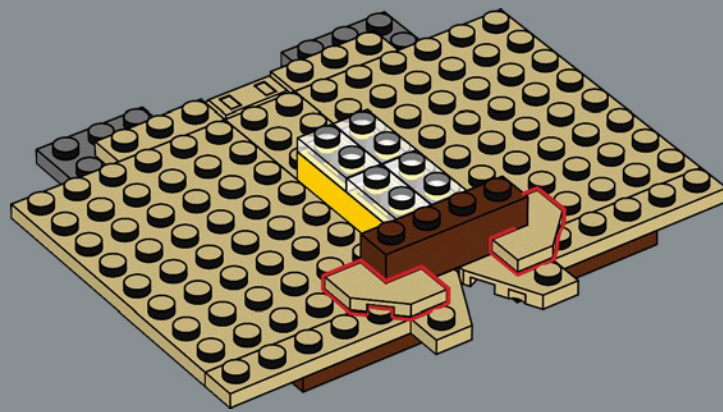

483

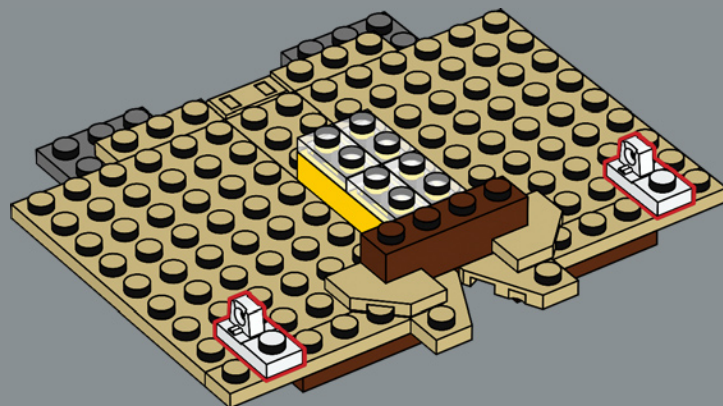



2x

484

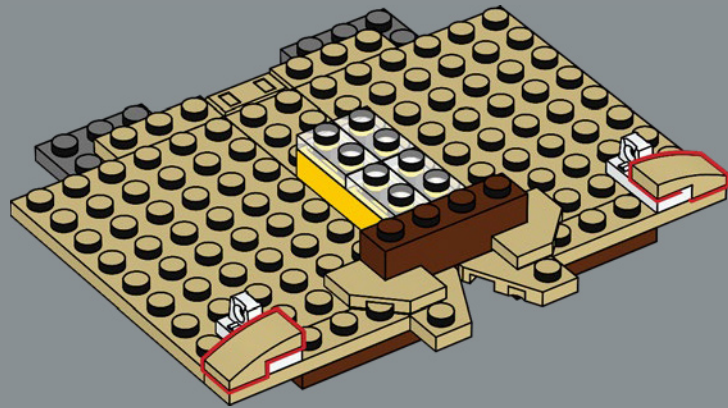

3x

485

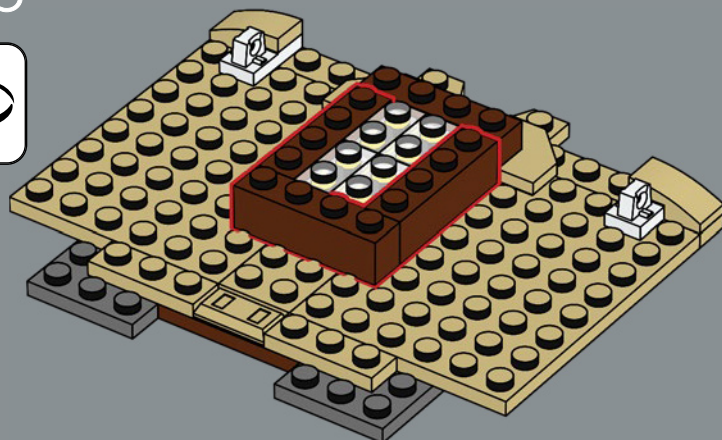

4x



8x

486

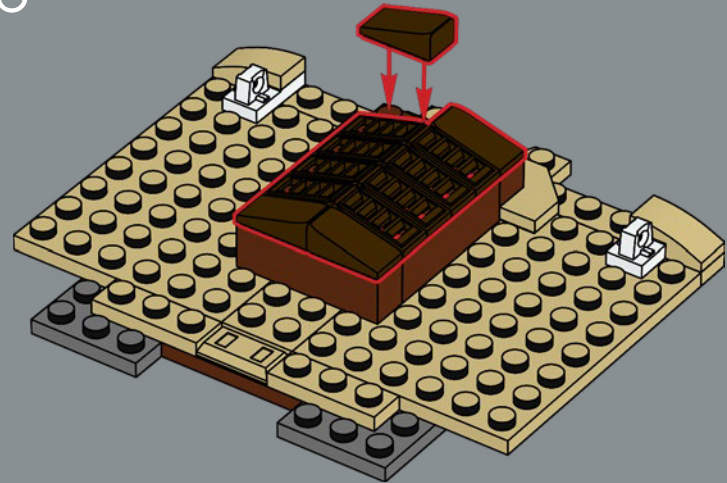

Per conferire alla parte superiore delle cabine del modello un aspetto più robusto, per la prima volta abbiamo realizzato piccoli elementi slope 1x2 per i tetti delle cabine in marrone scuro.

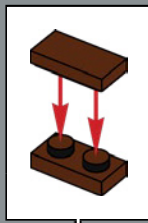
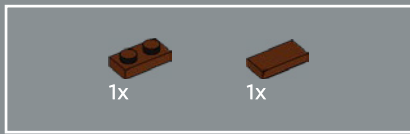

487

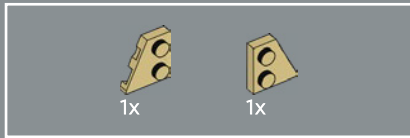
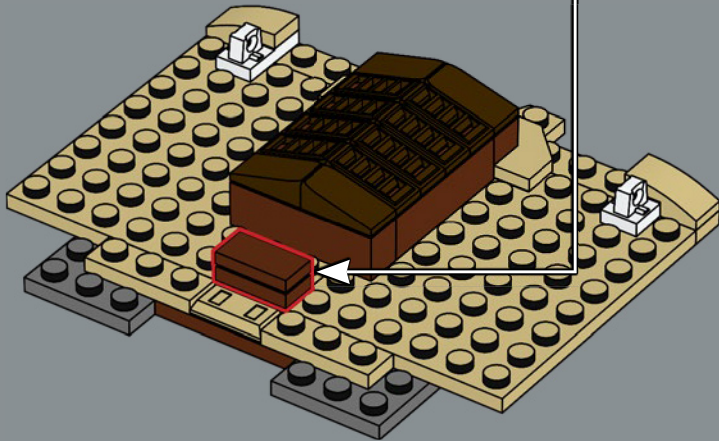

488

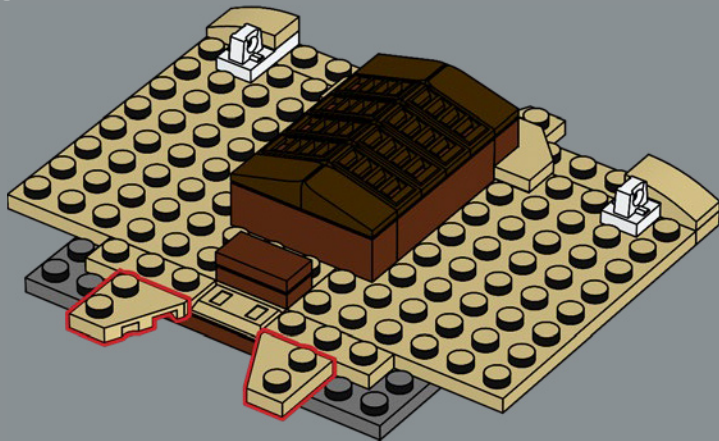

489

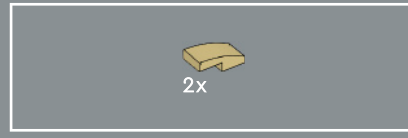
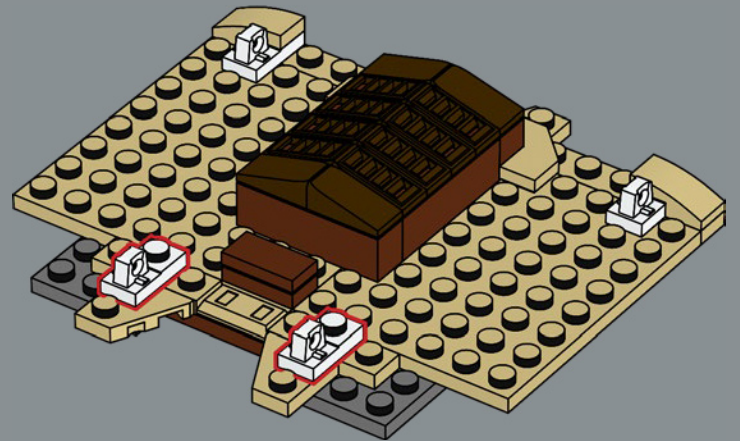

490

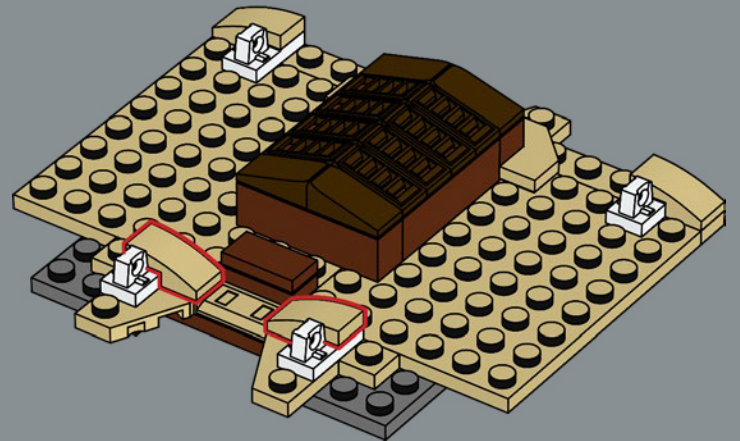

2x

491

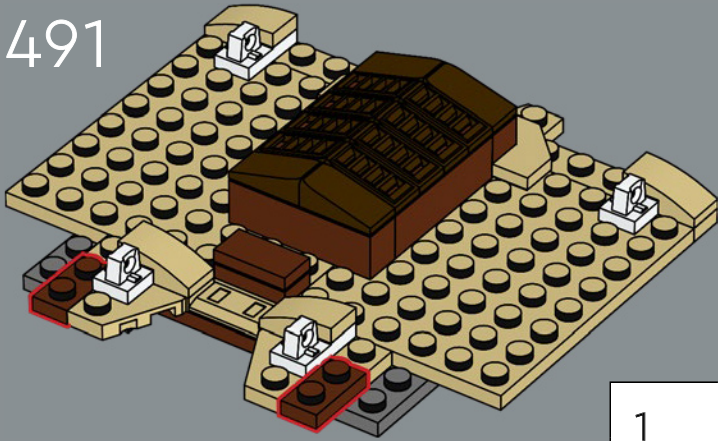

2x

2x

2x

492

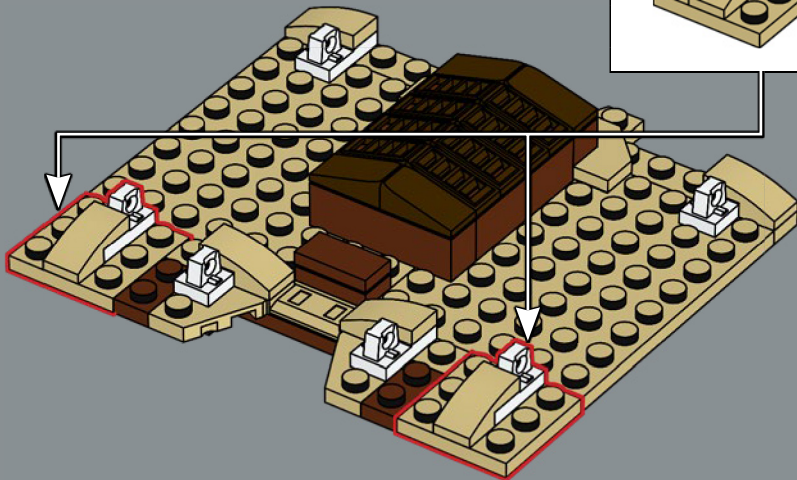

1

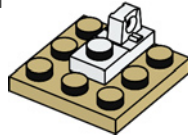

2

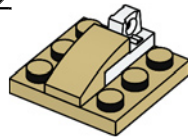

2x

4x

493

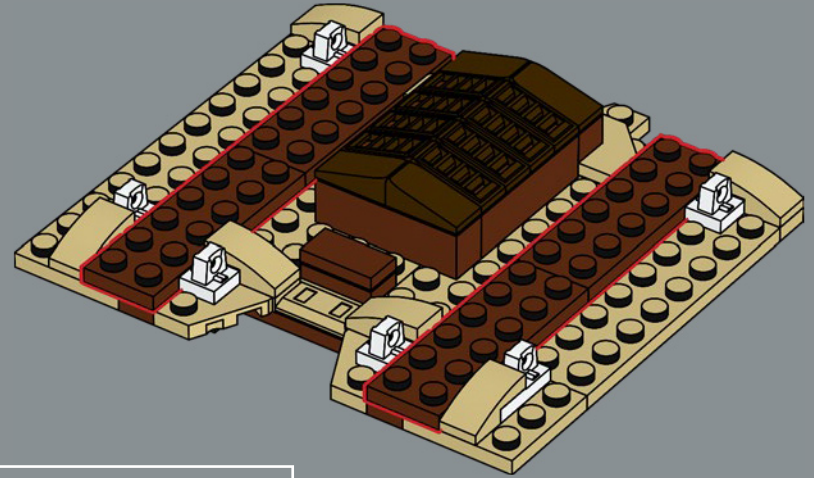

4x



4x

494

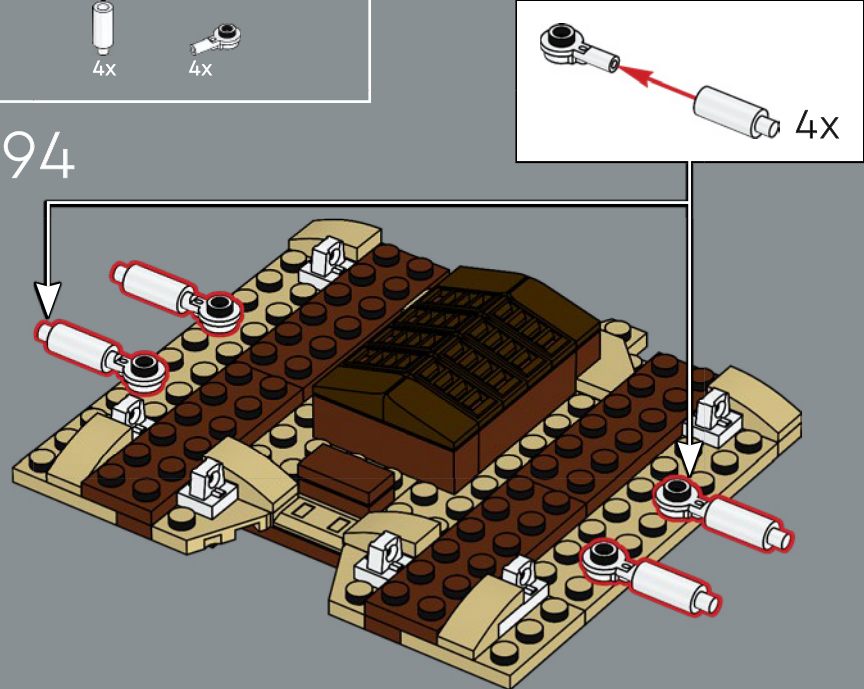

4x



495

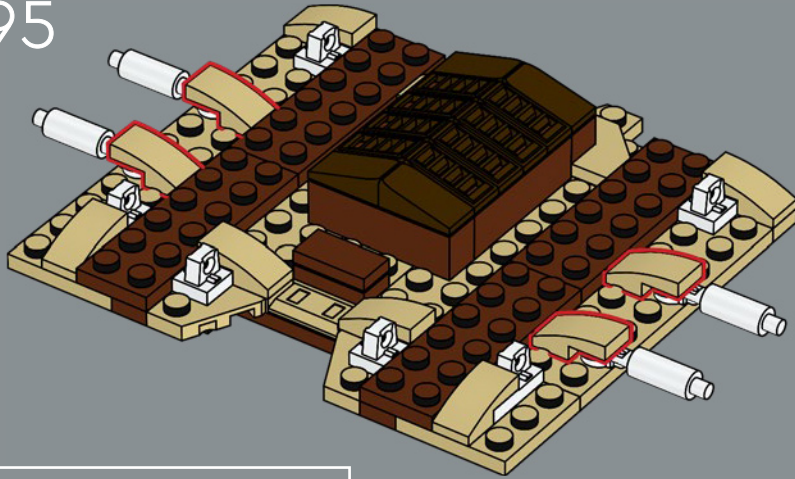

496

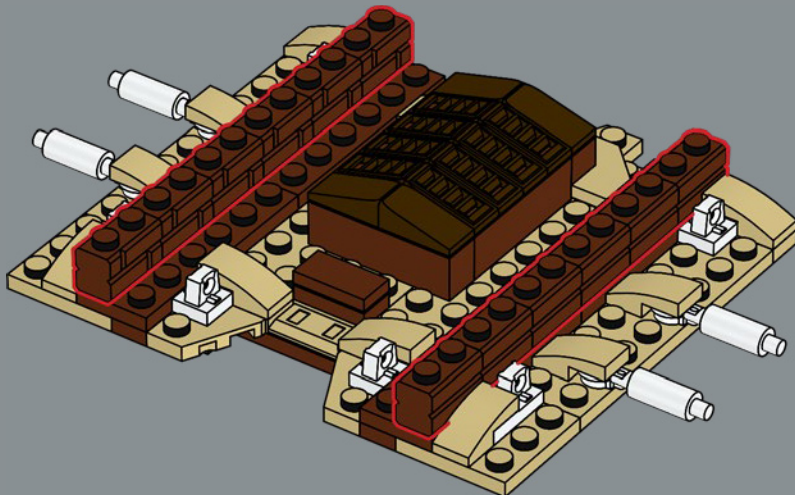

497

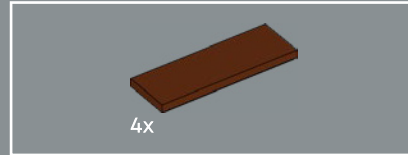
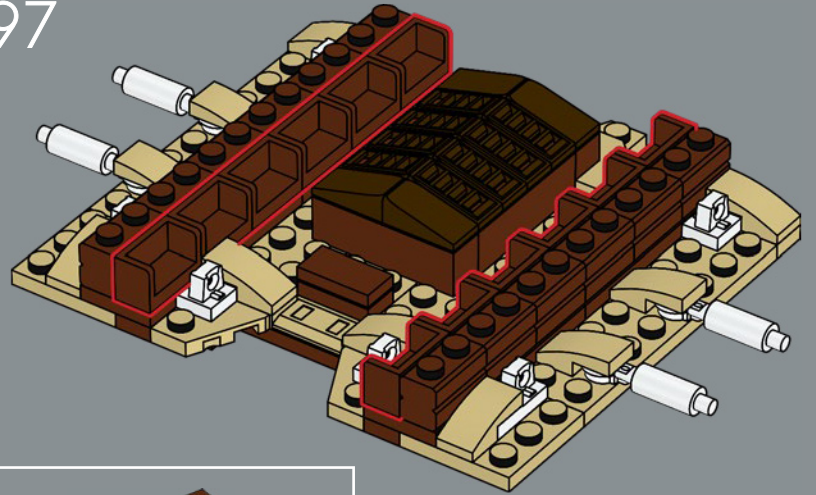

498

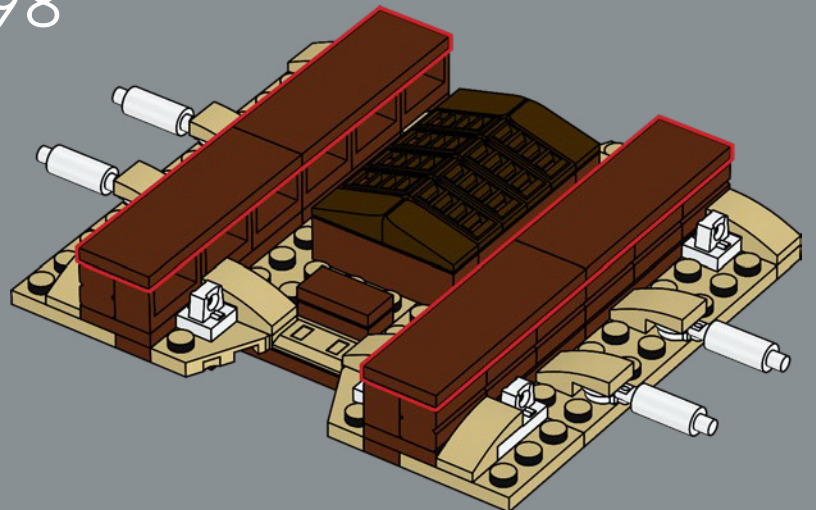

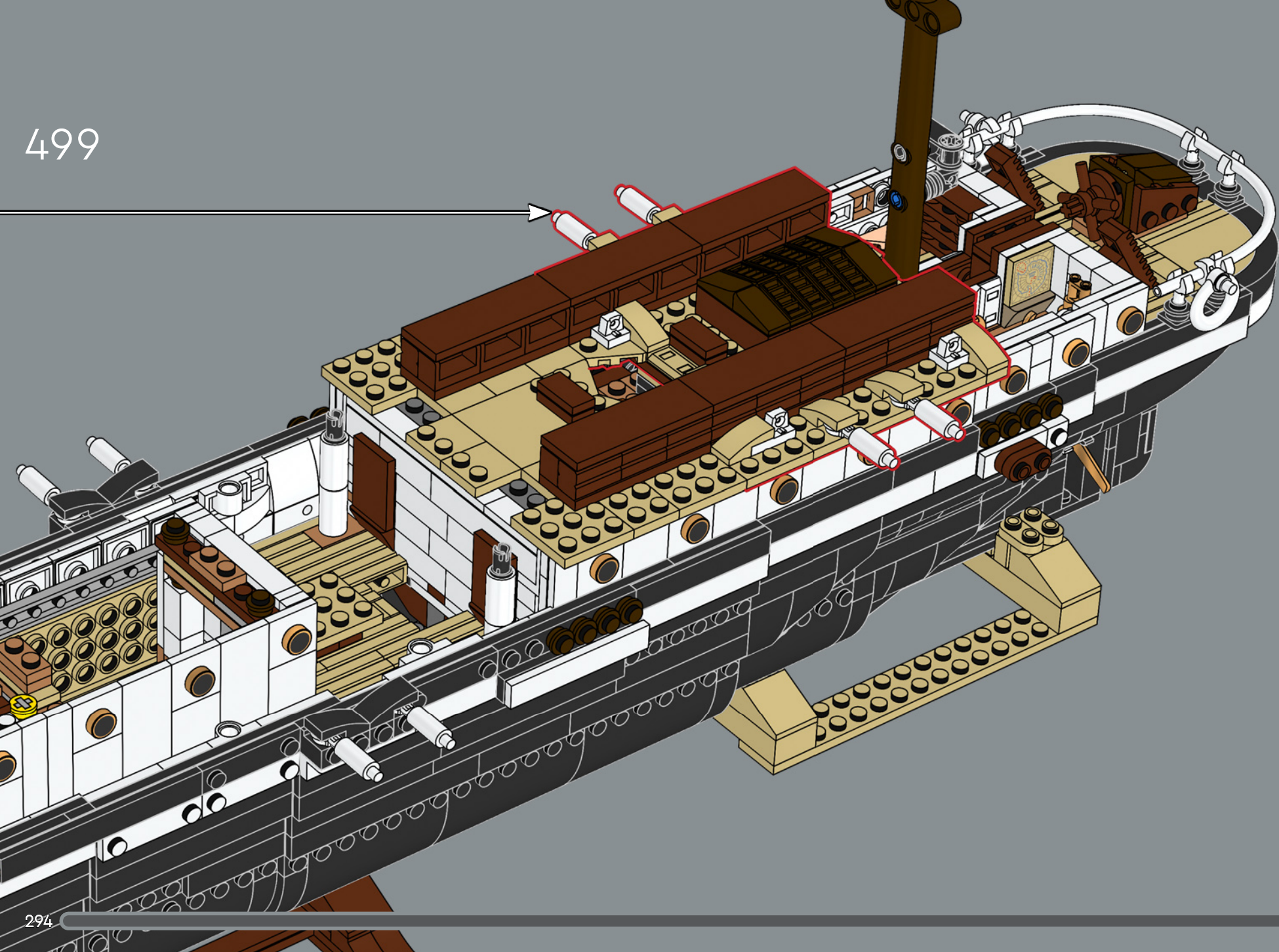

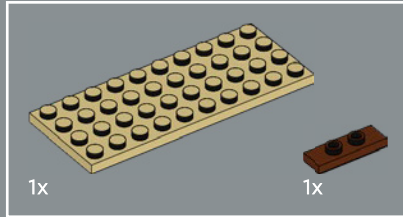
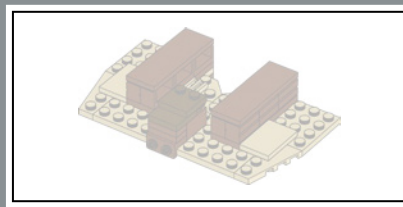

500

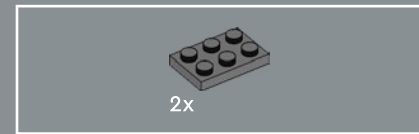
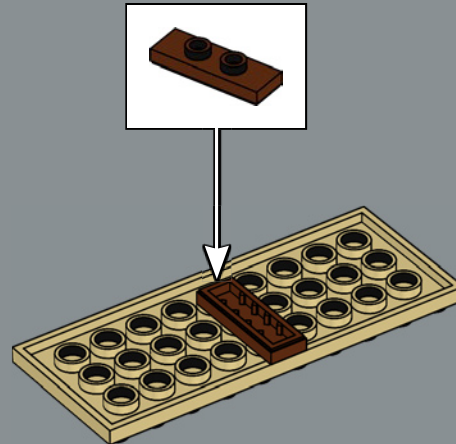

501

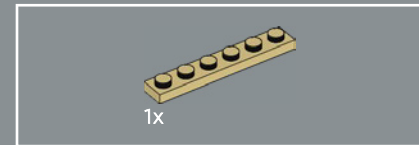
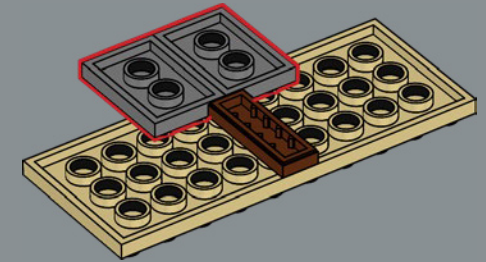

502

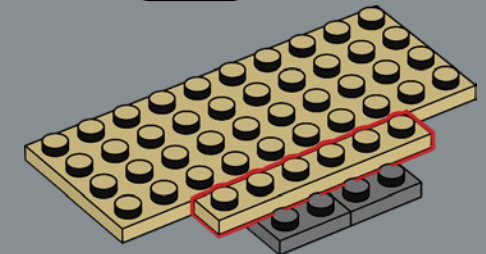

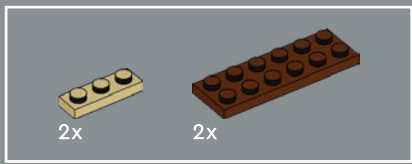

503

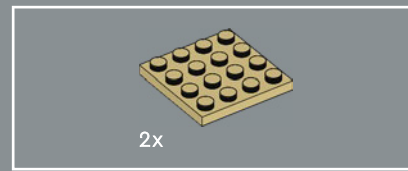
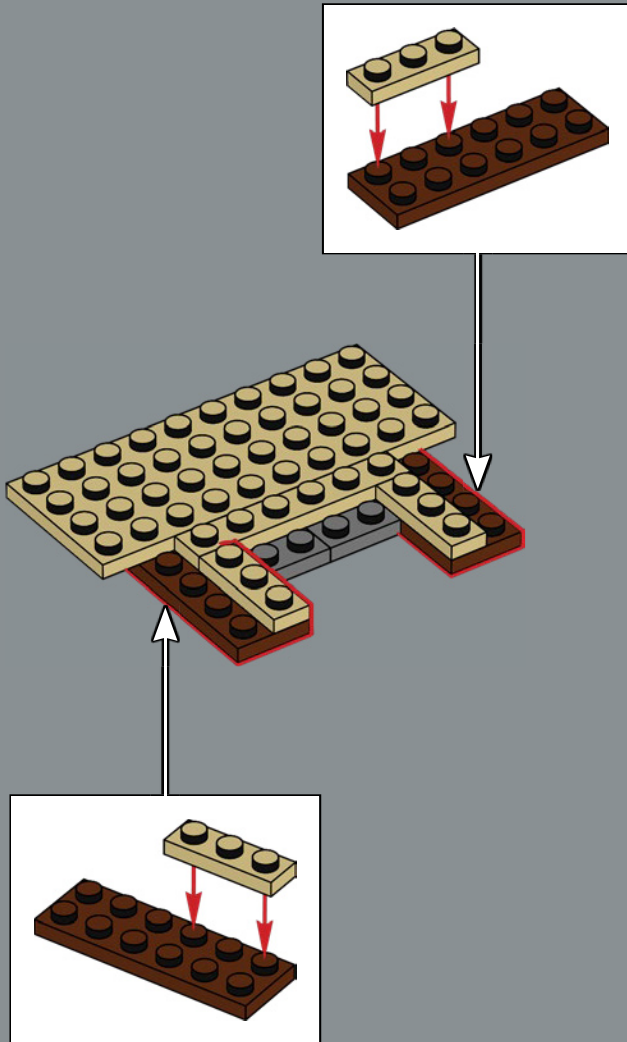

504

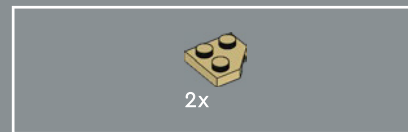
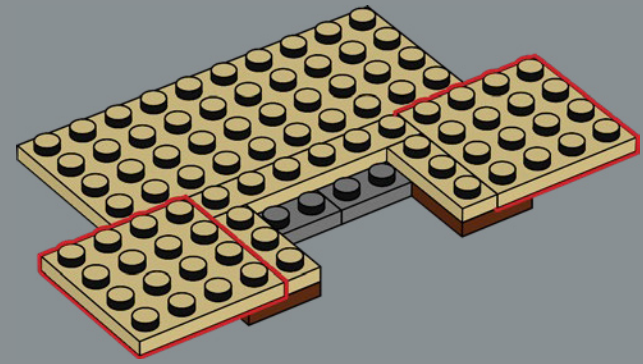

505

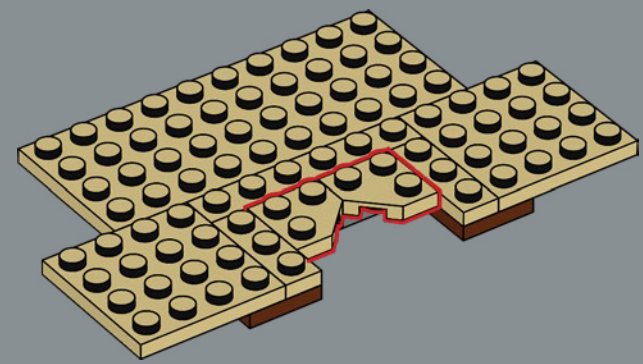

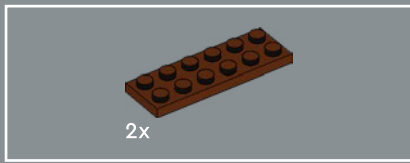

506

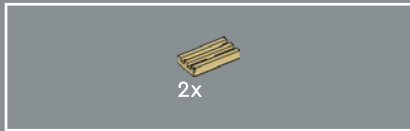
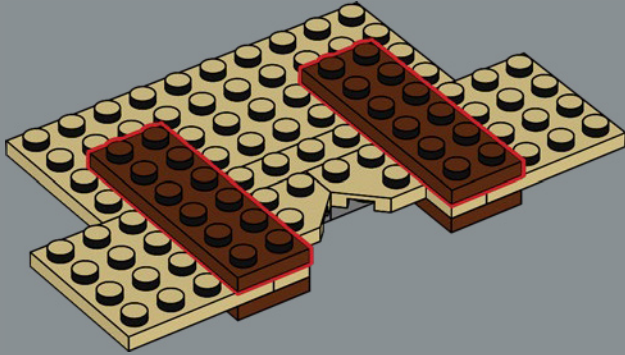

507

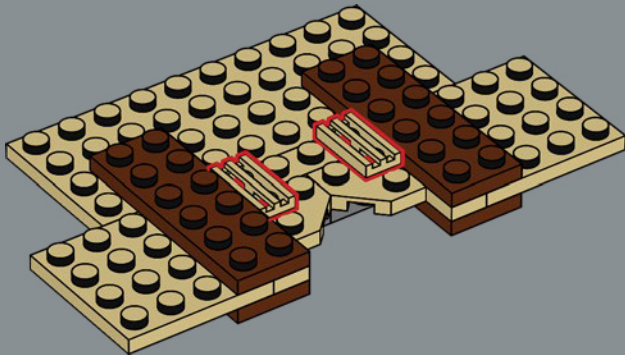

508

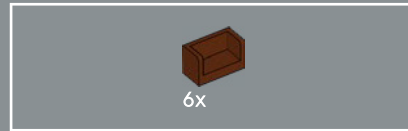
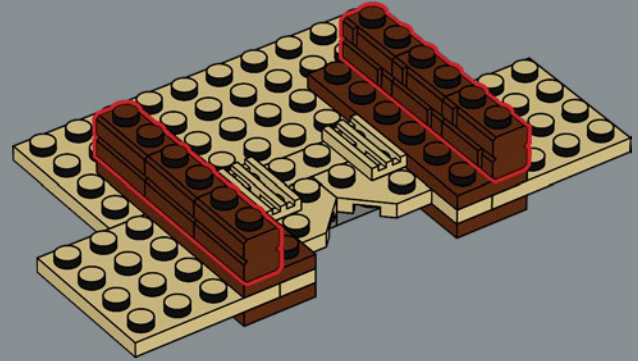

509

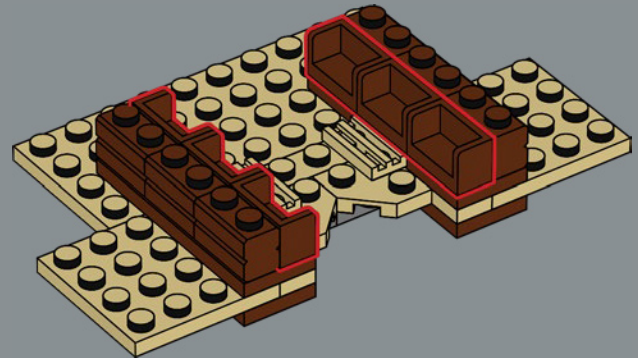

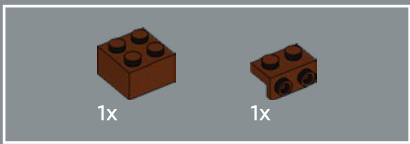

510

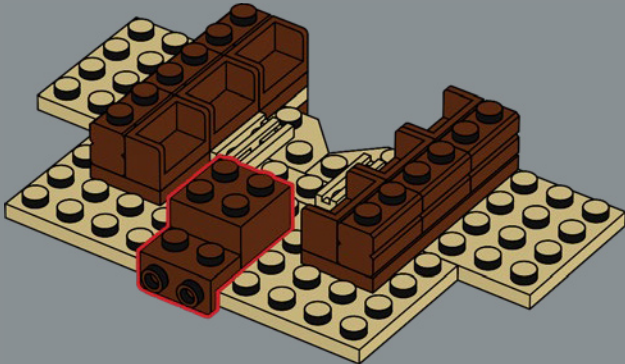

511

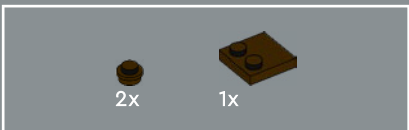
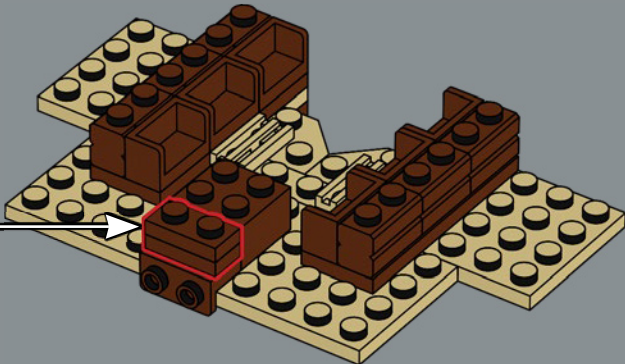
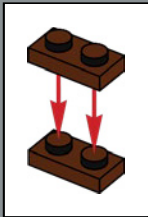

512

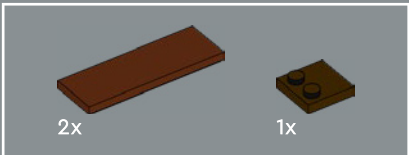
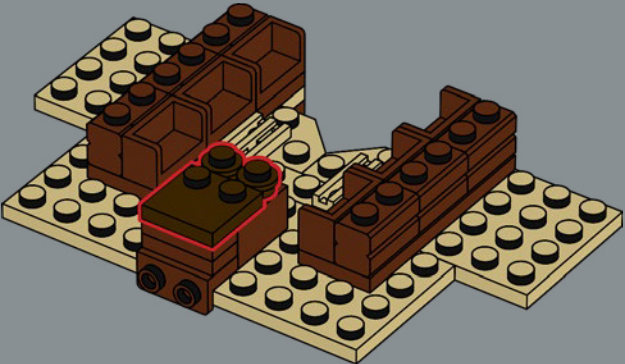

513

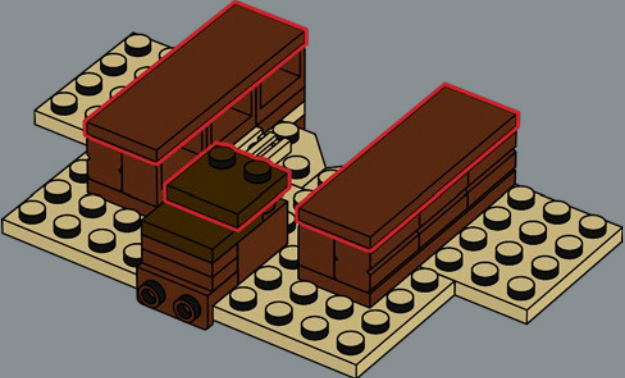

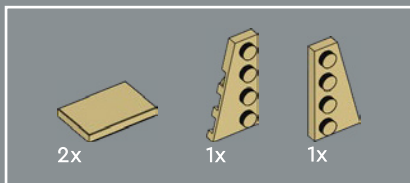

514

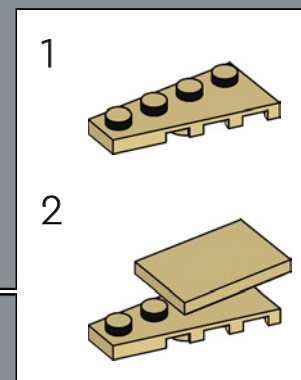
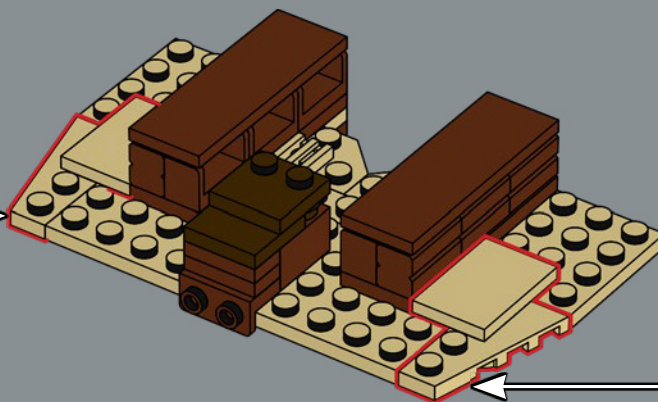
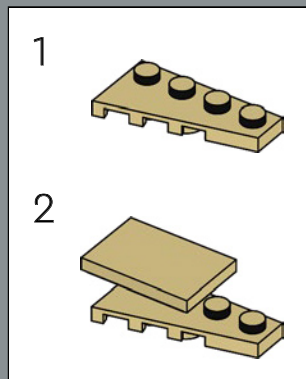

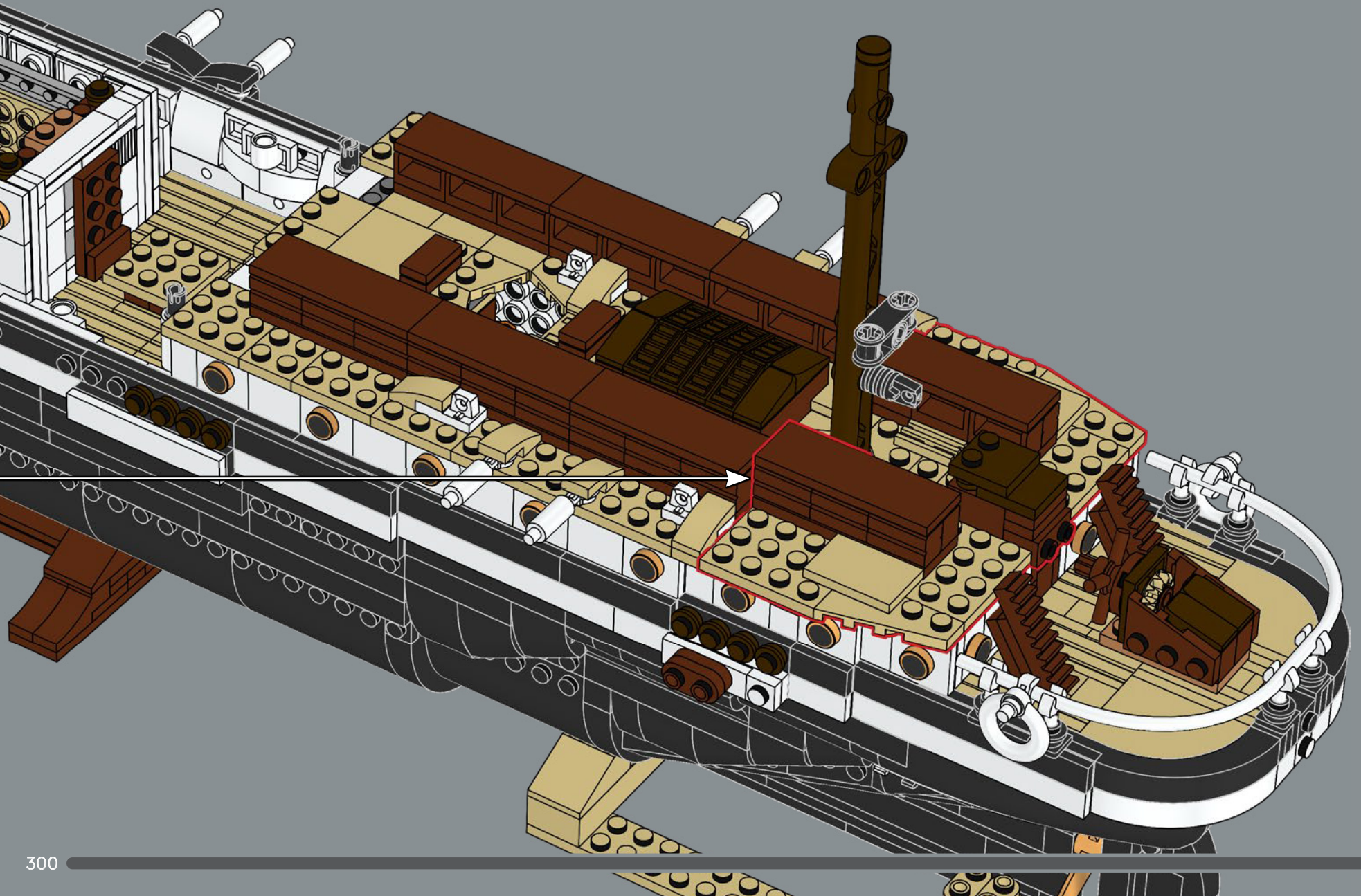

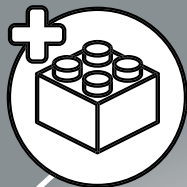

2x

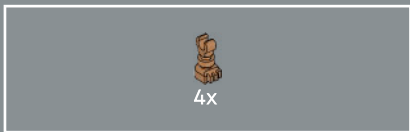

4x

516

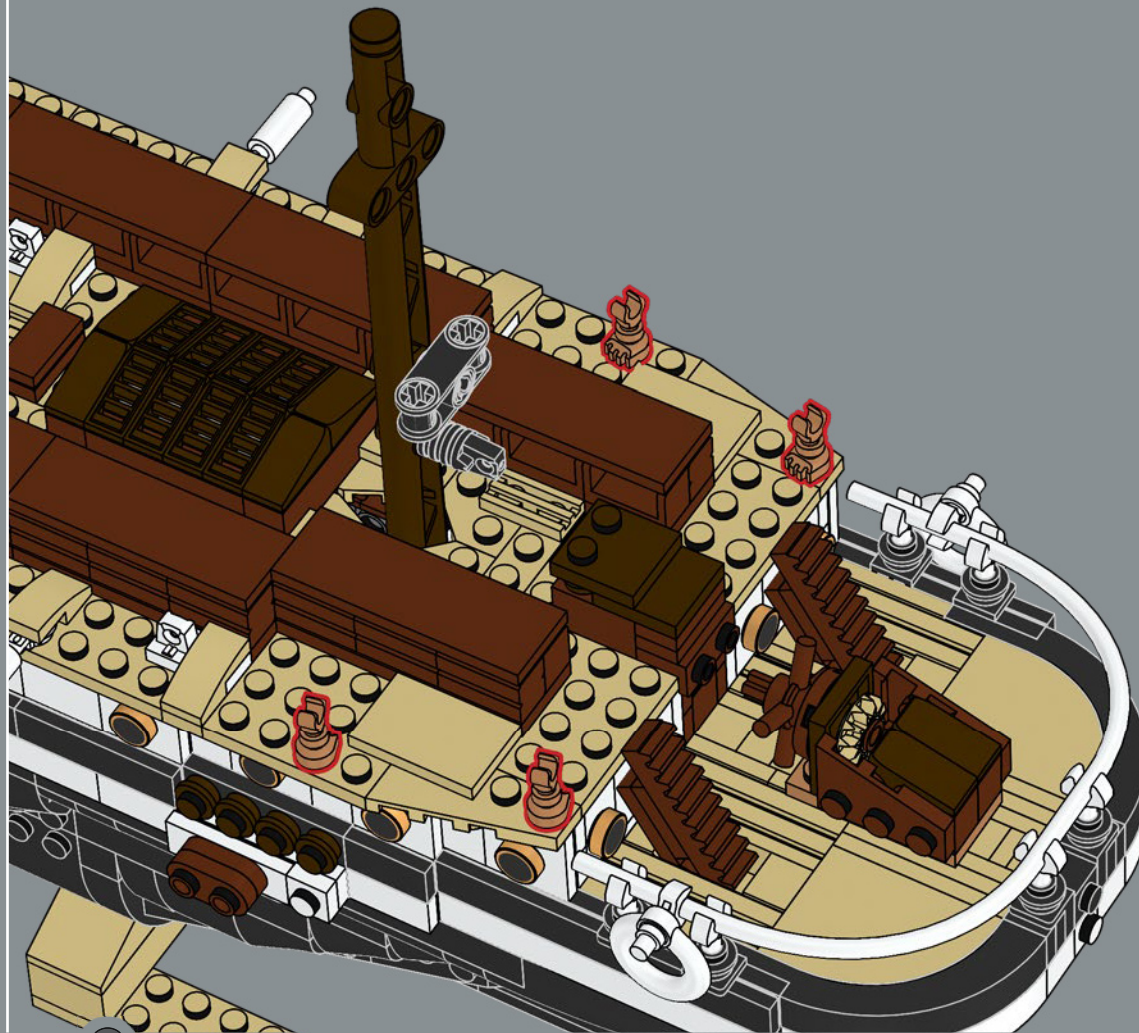



517

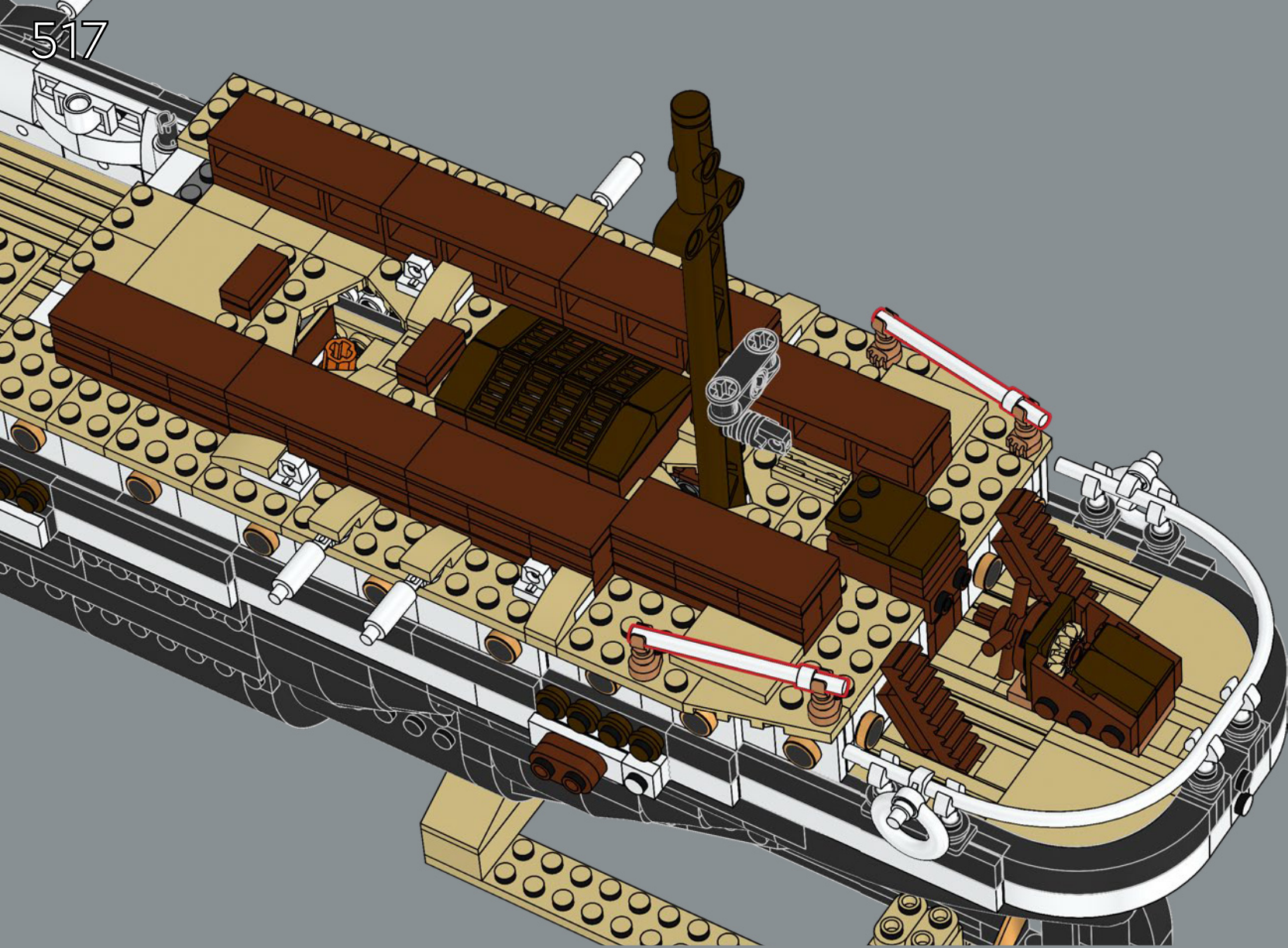

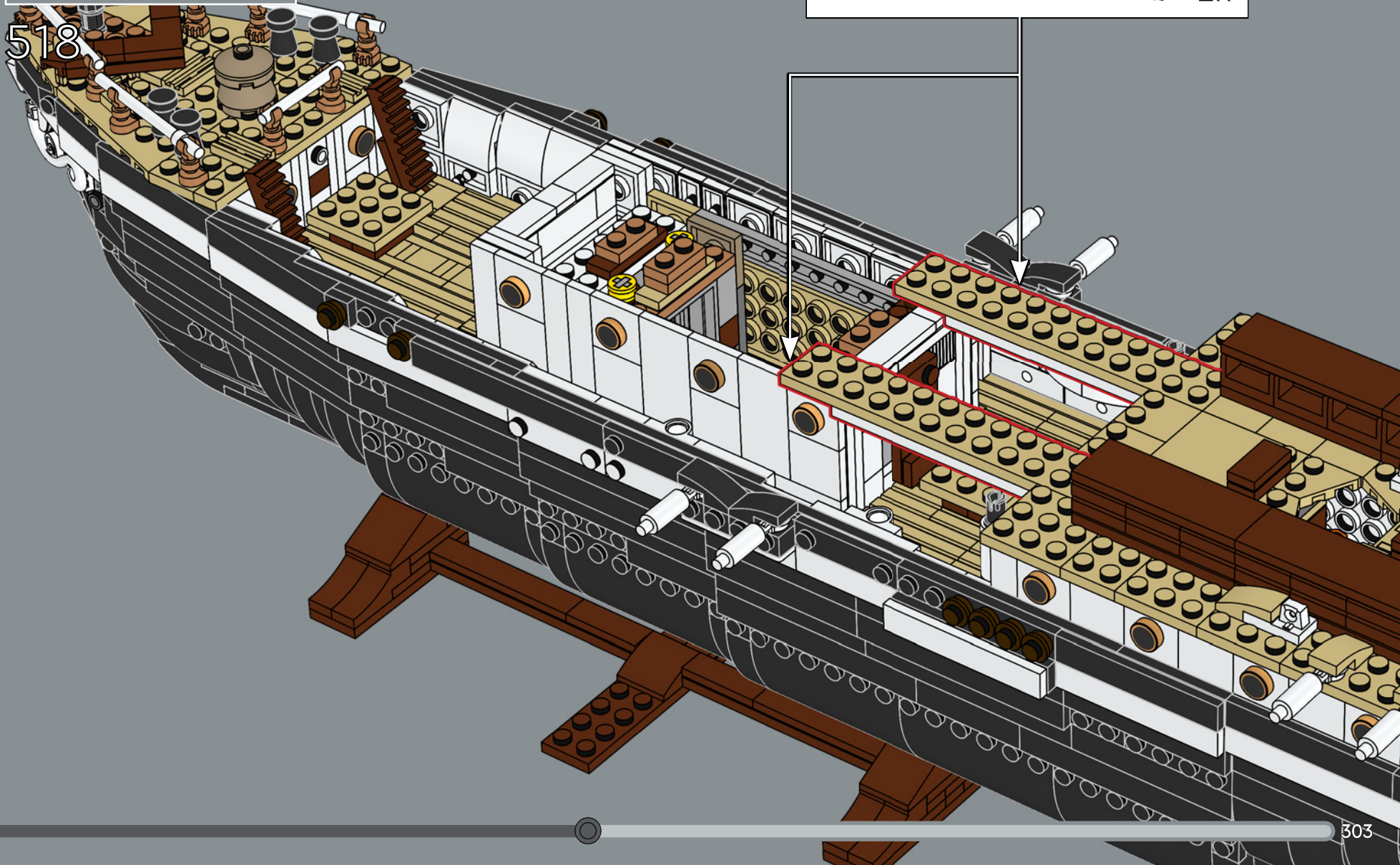
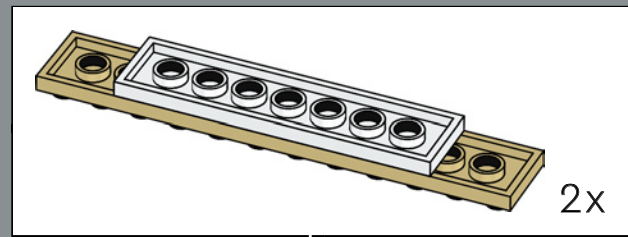
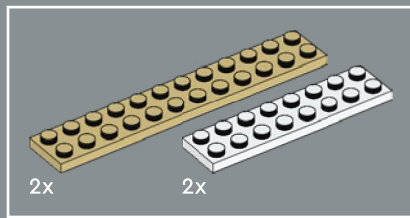

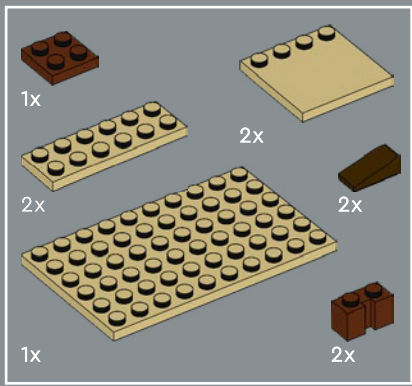

519

1

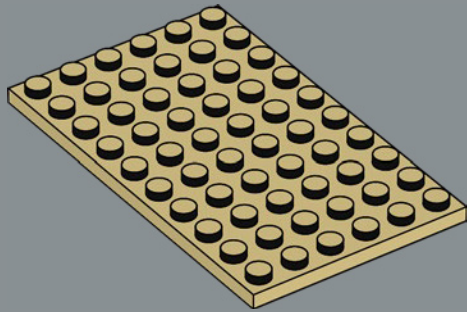

2

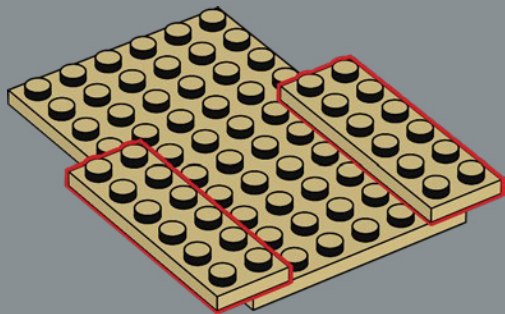

3

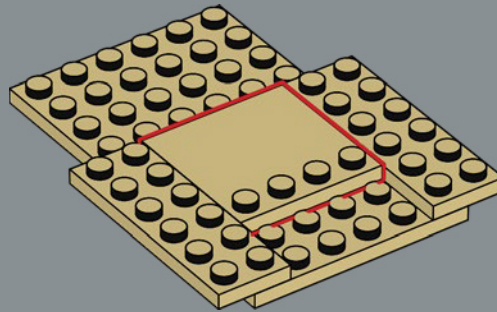

4

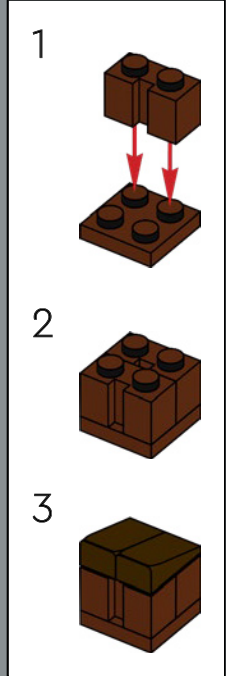
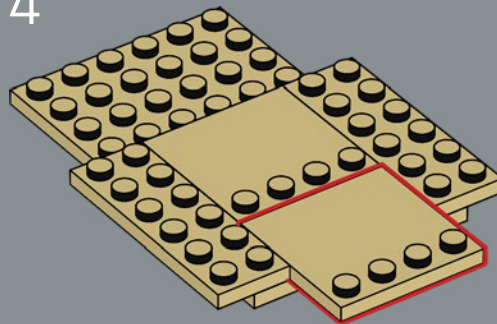

5

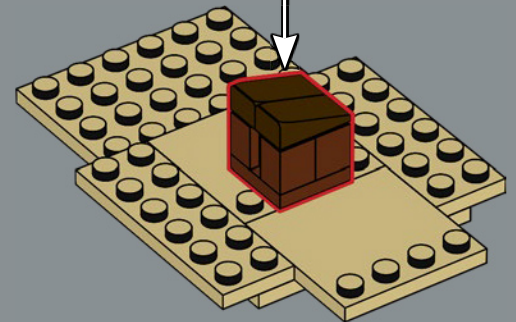

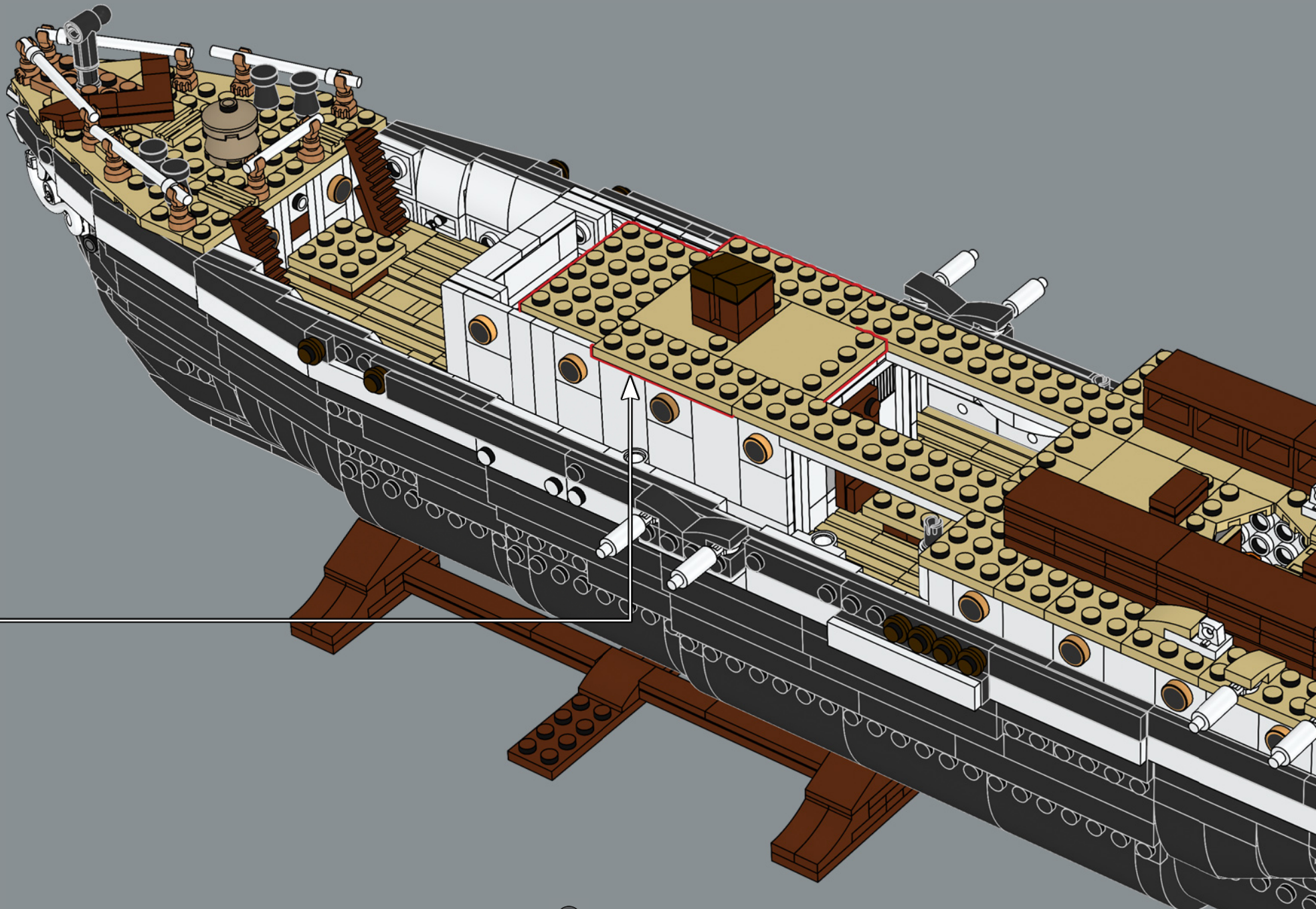

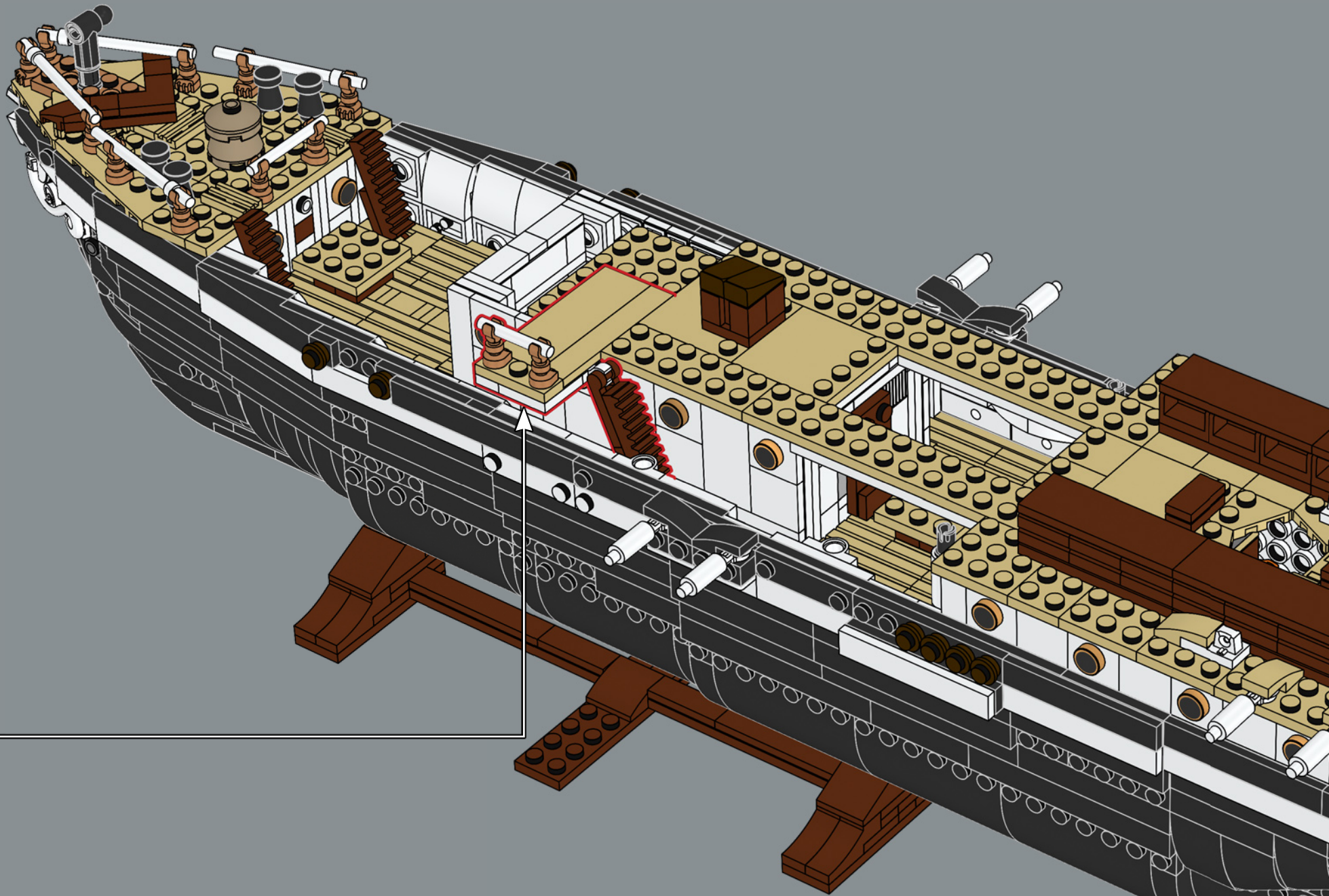

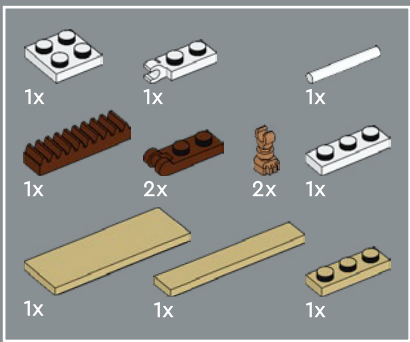

521

1

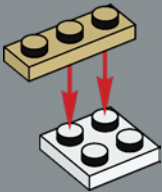

2

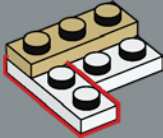

3

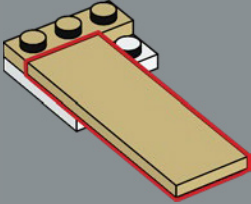

4

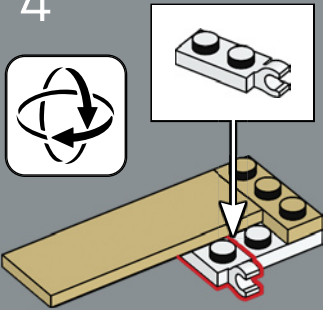

5

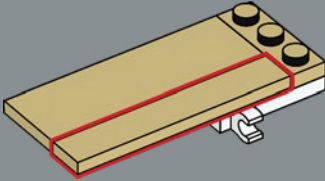

6

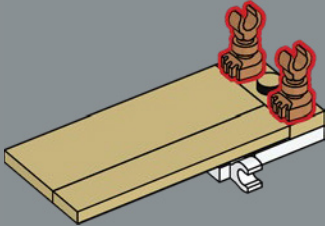

7

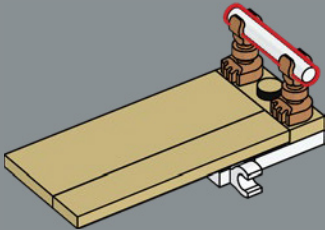

8

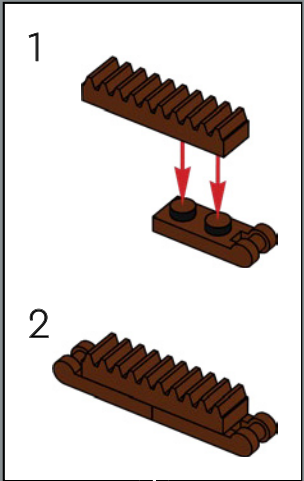

9

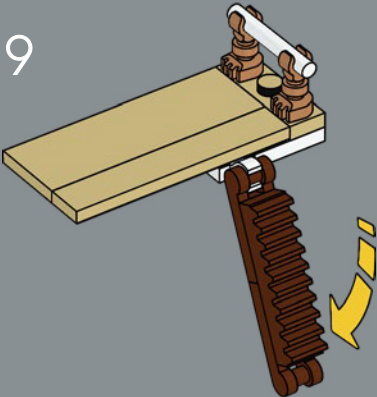

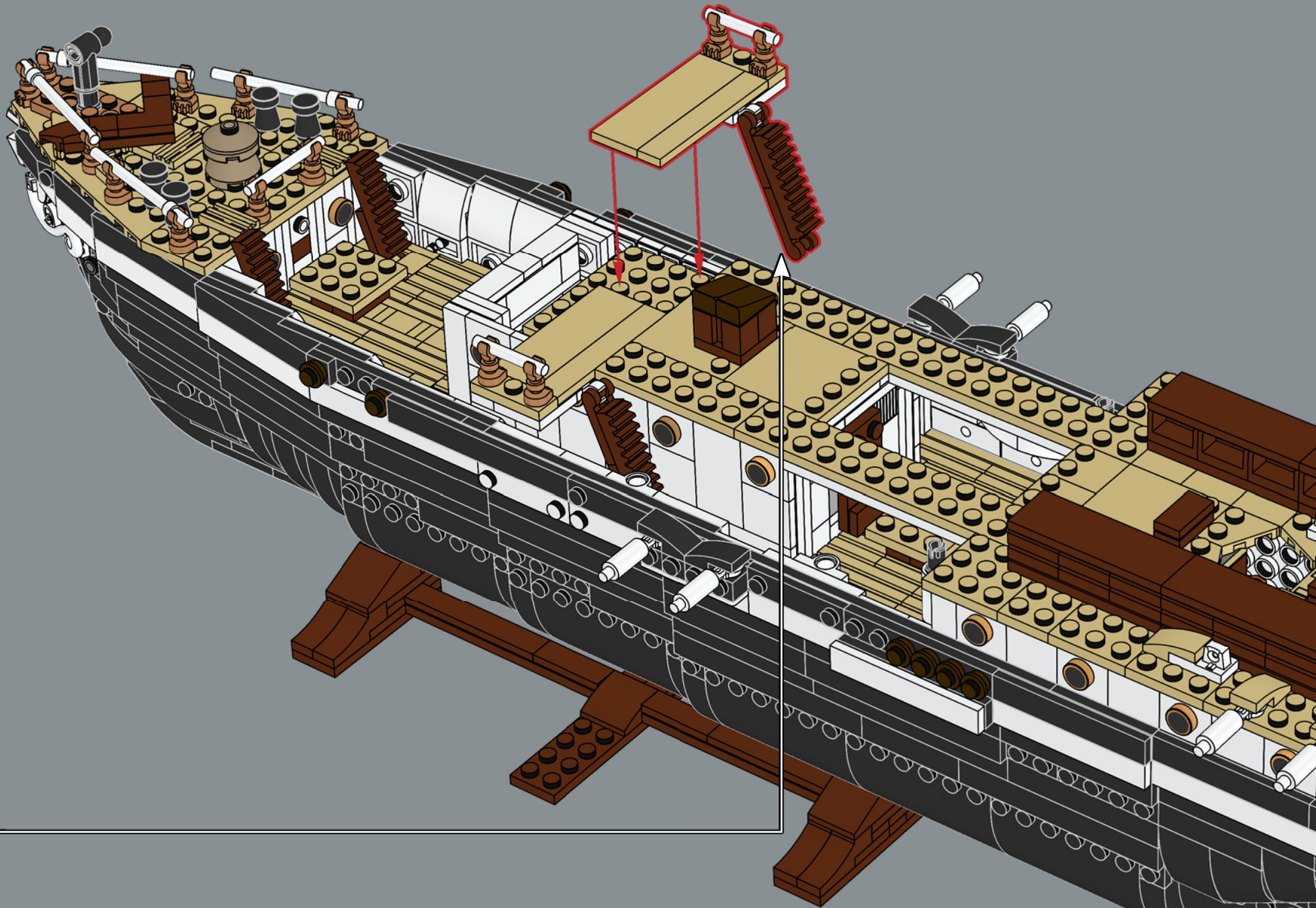

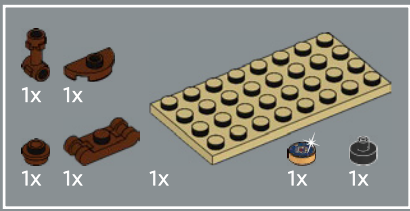

522

1

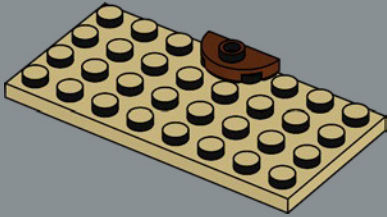

2

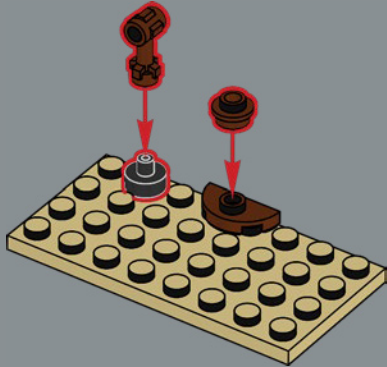

3

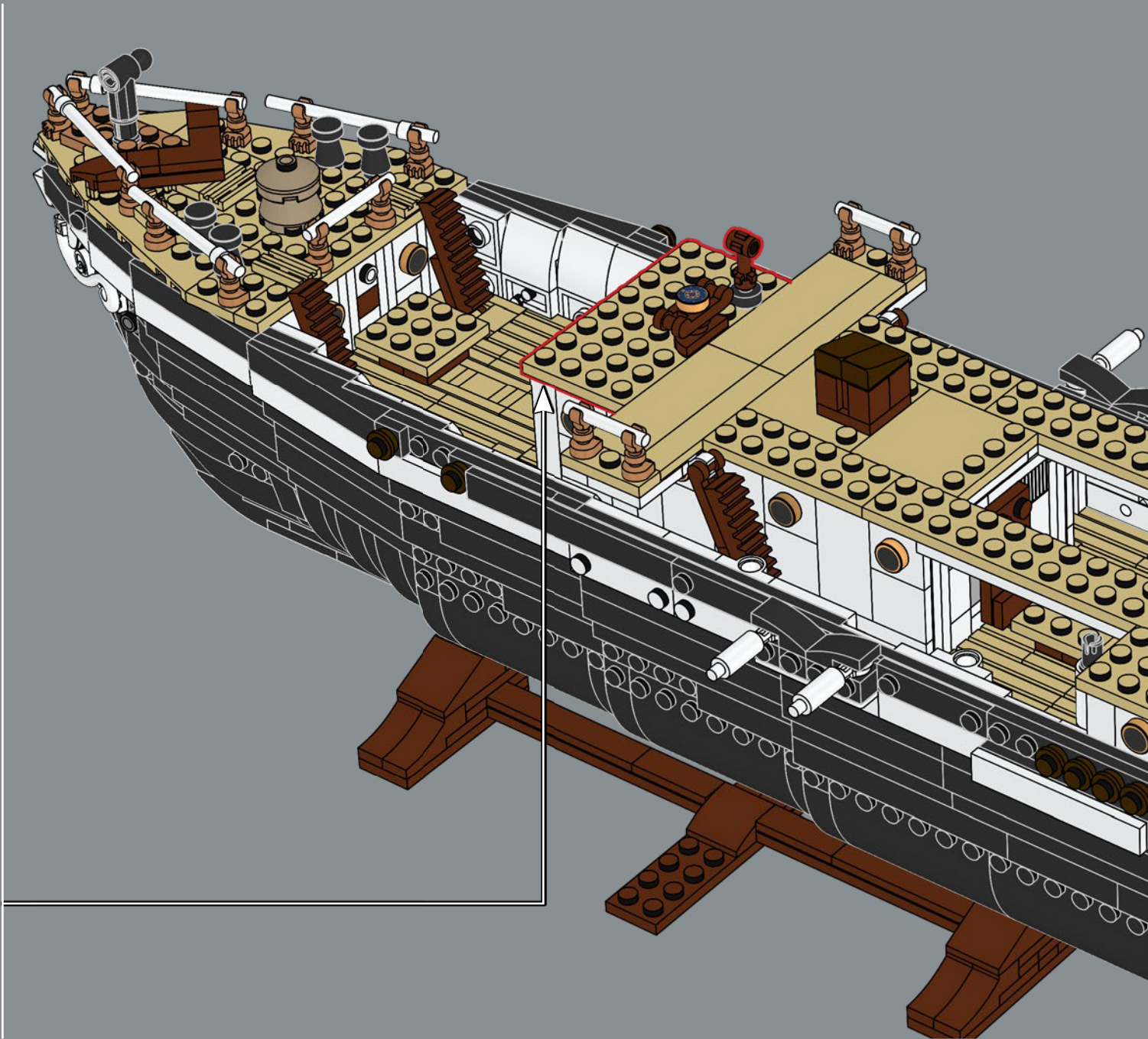

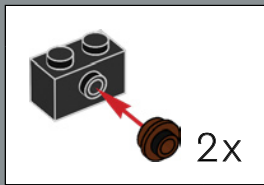

523

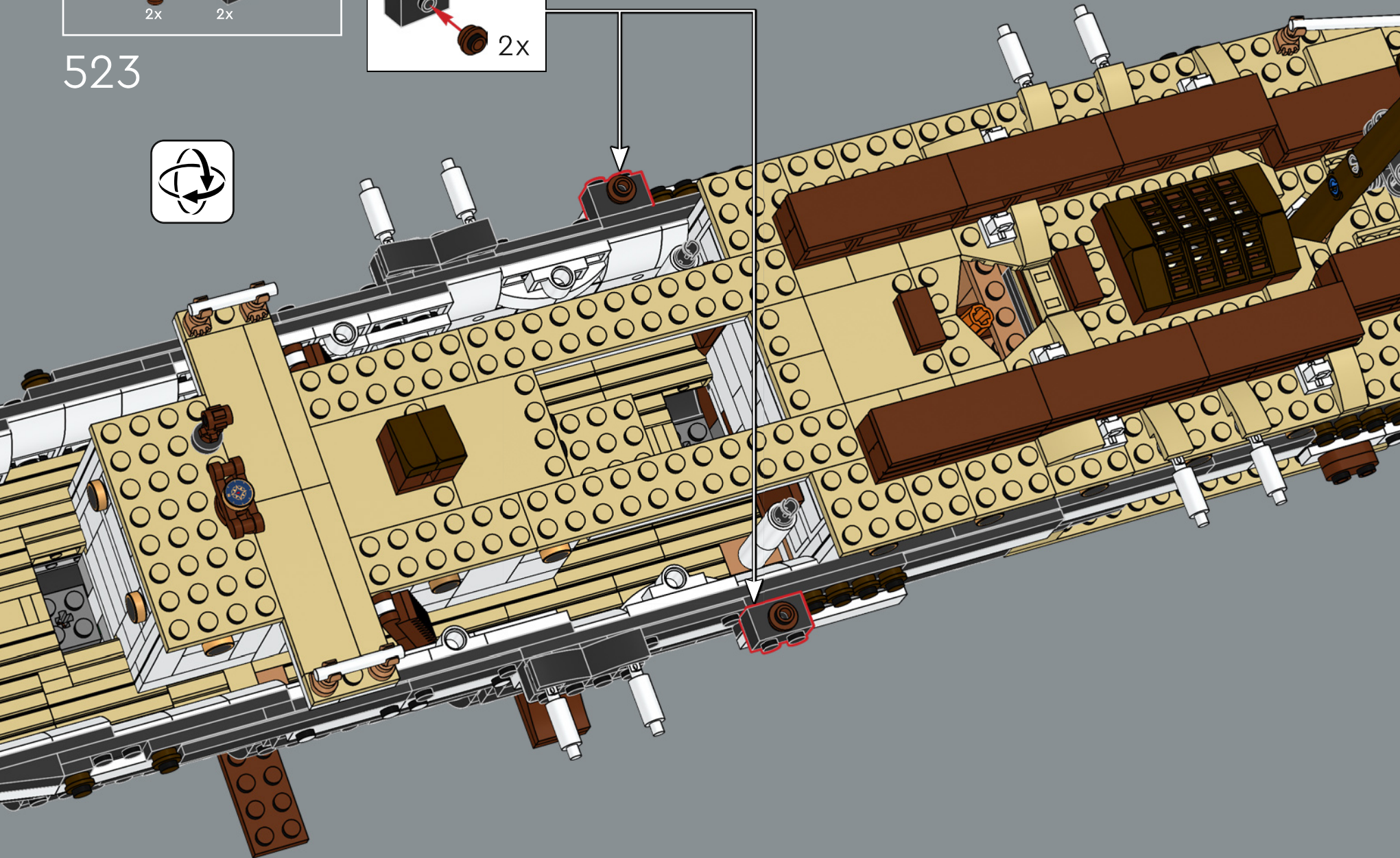



38x

524

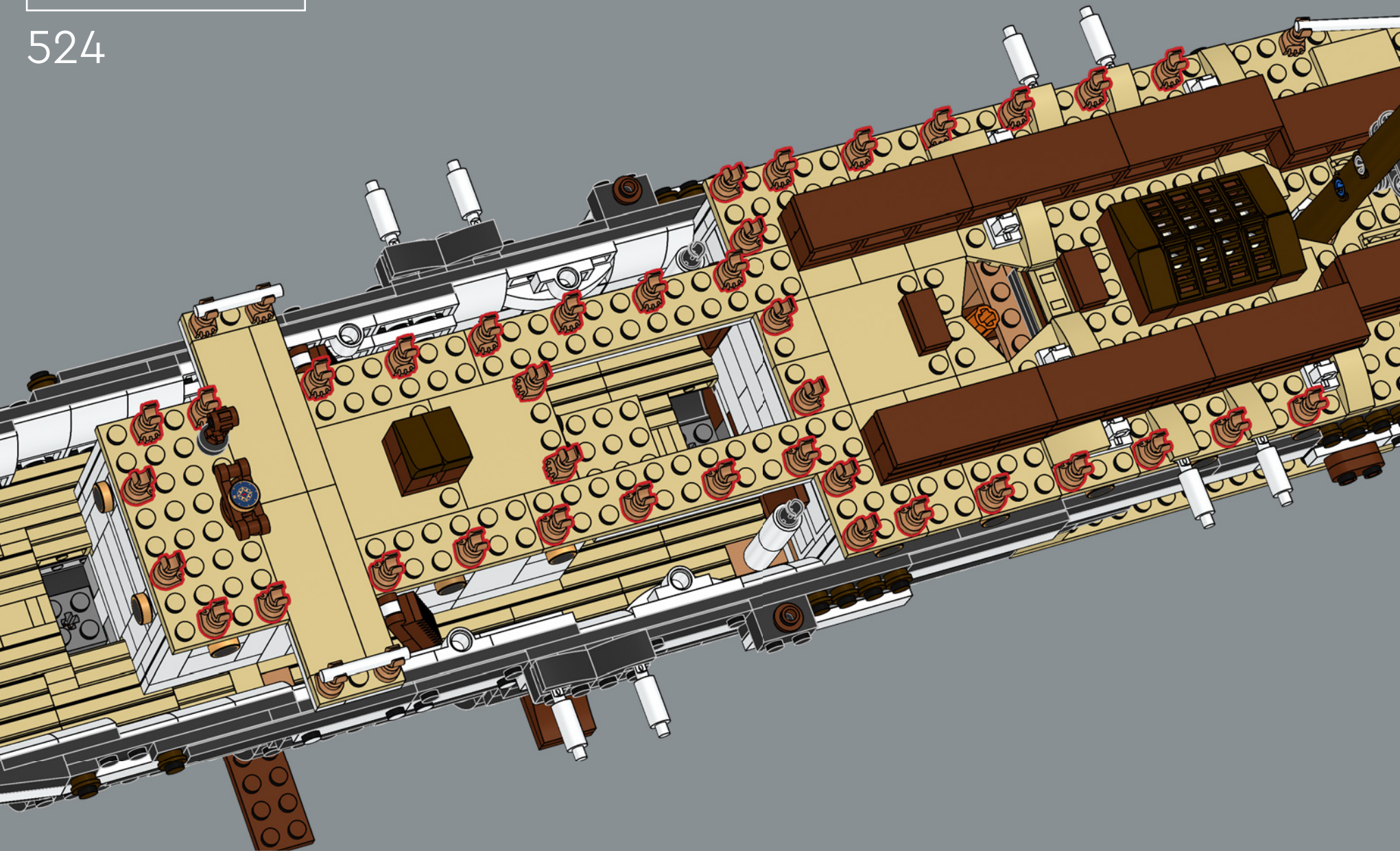

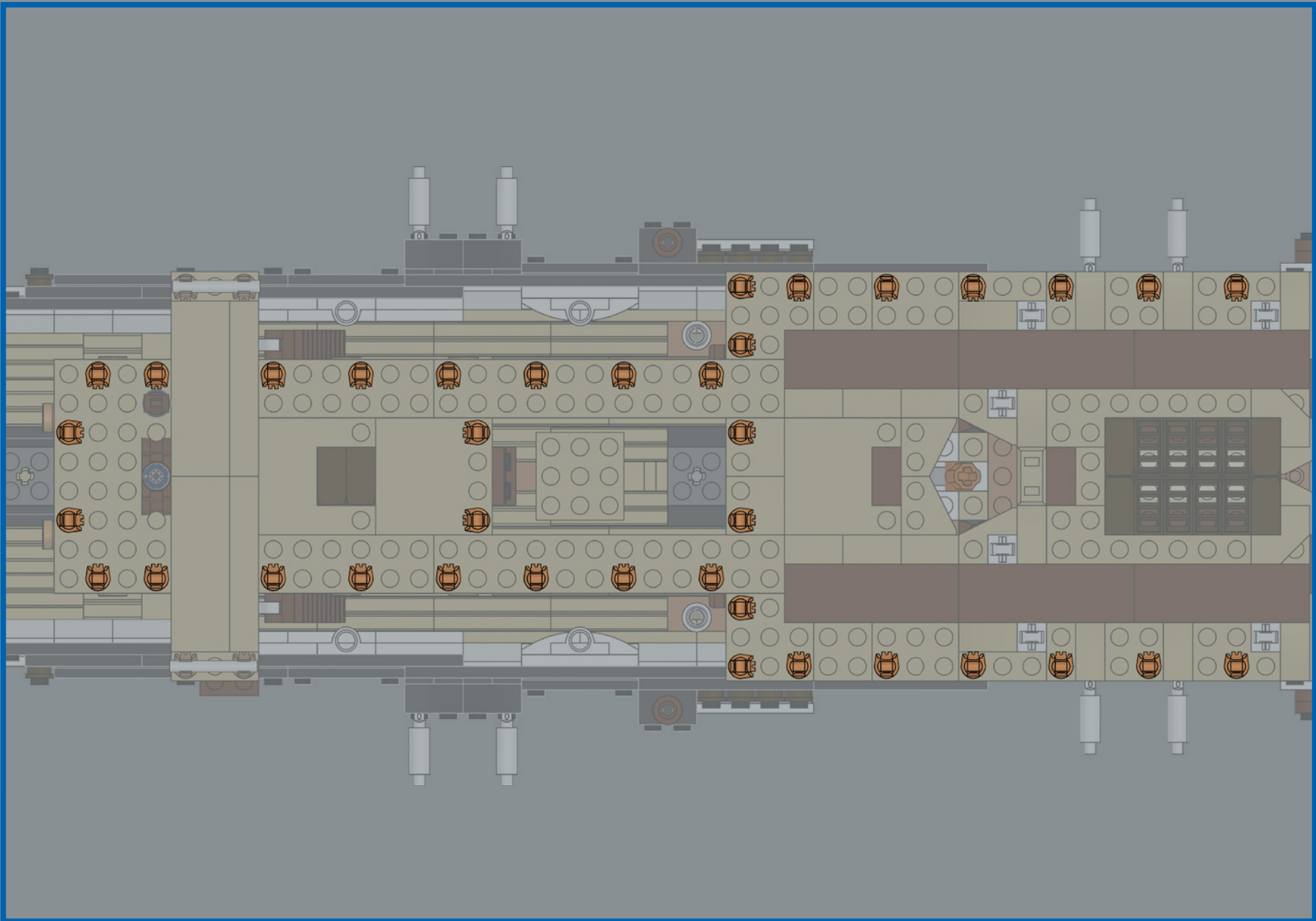

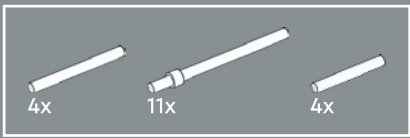

525

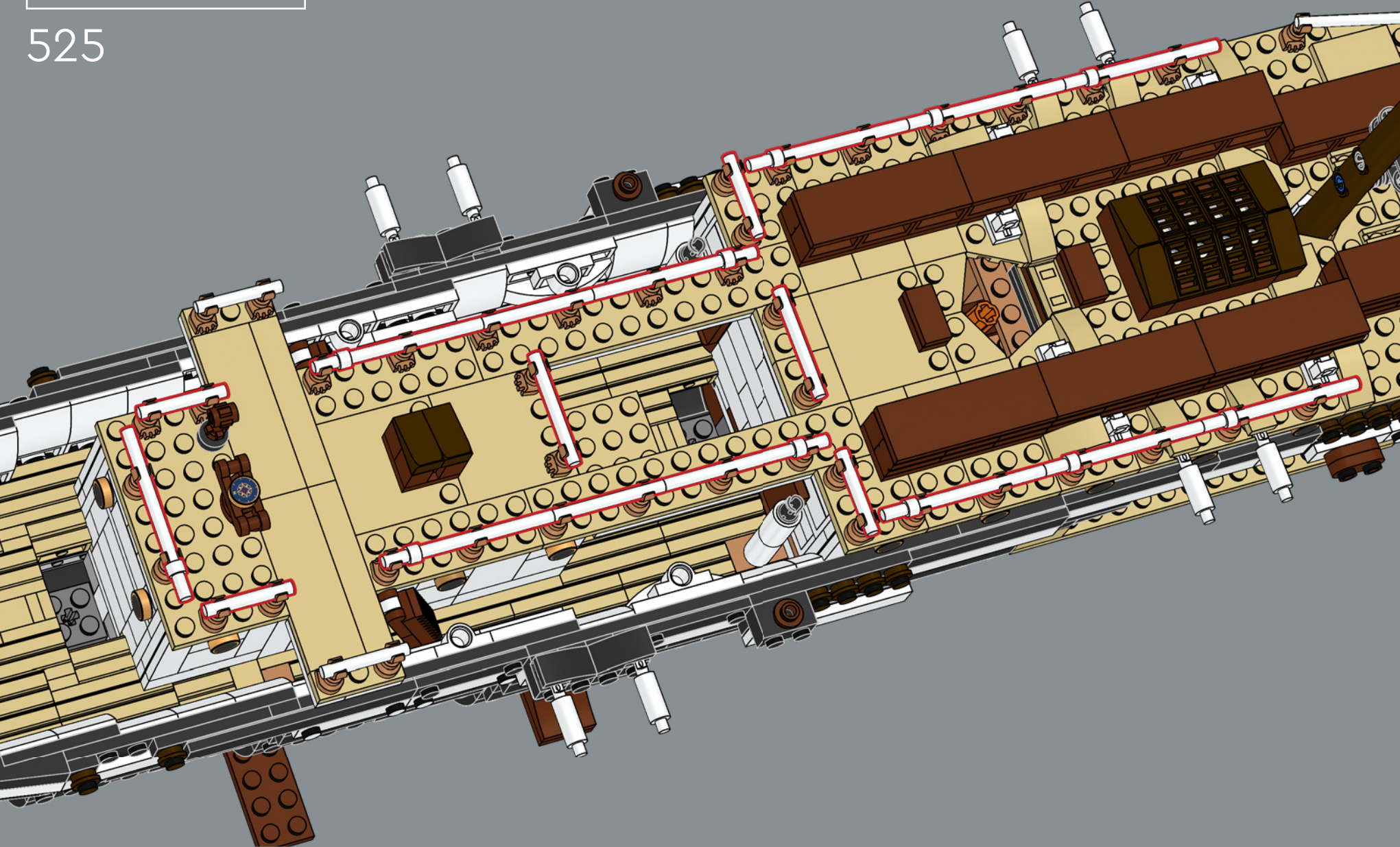

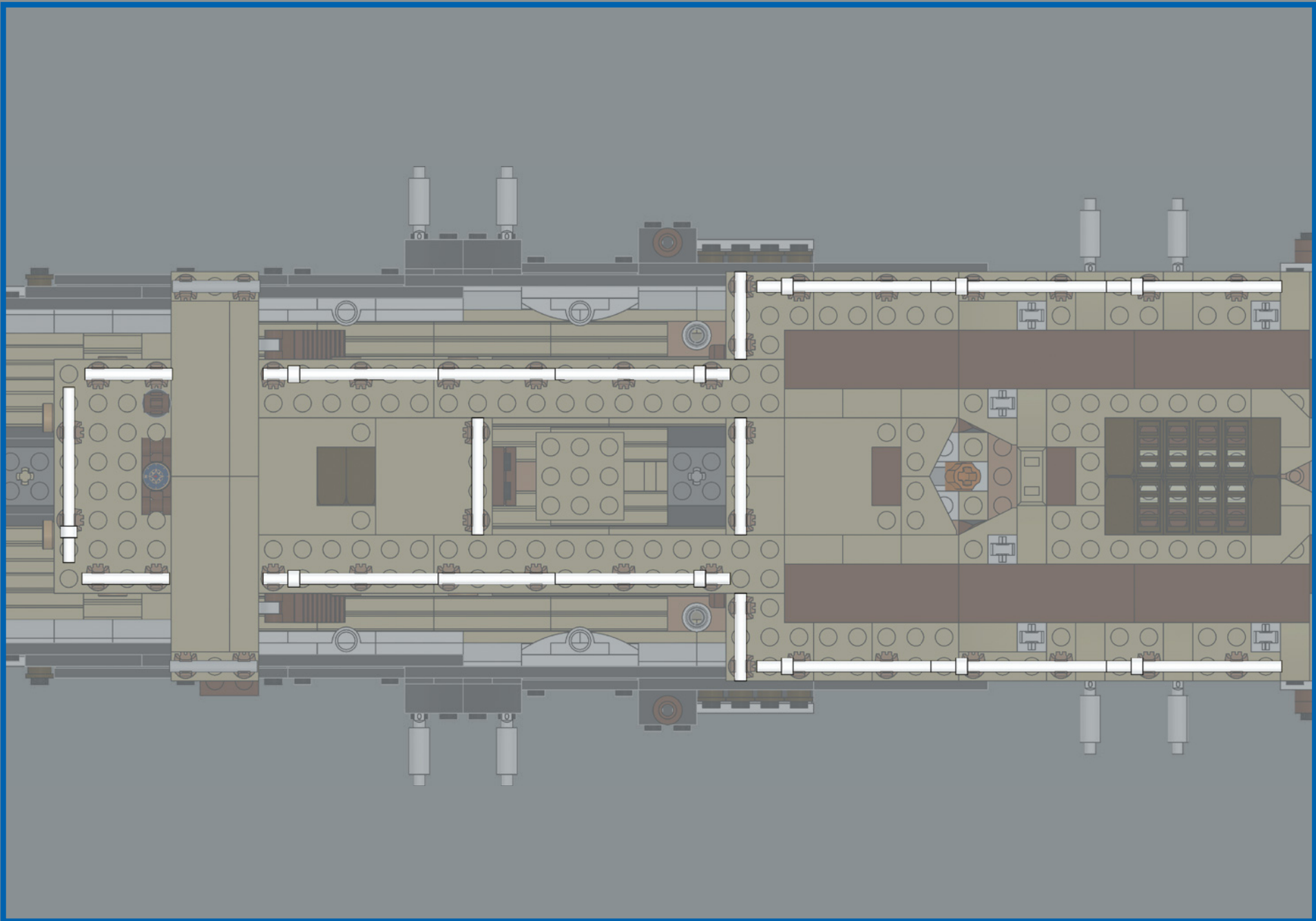

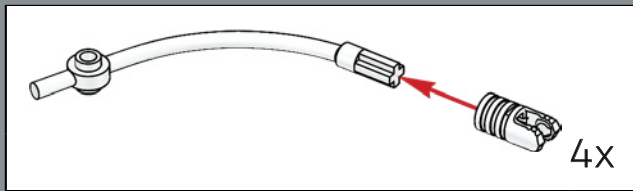
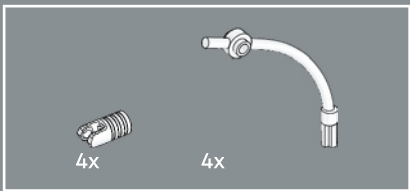

526

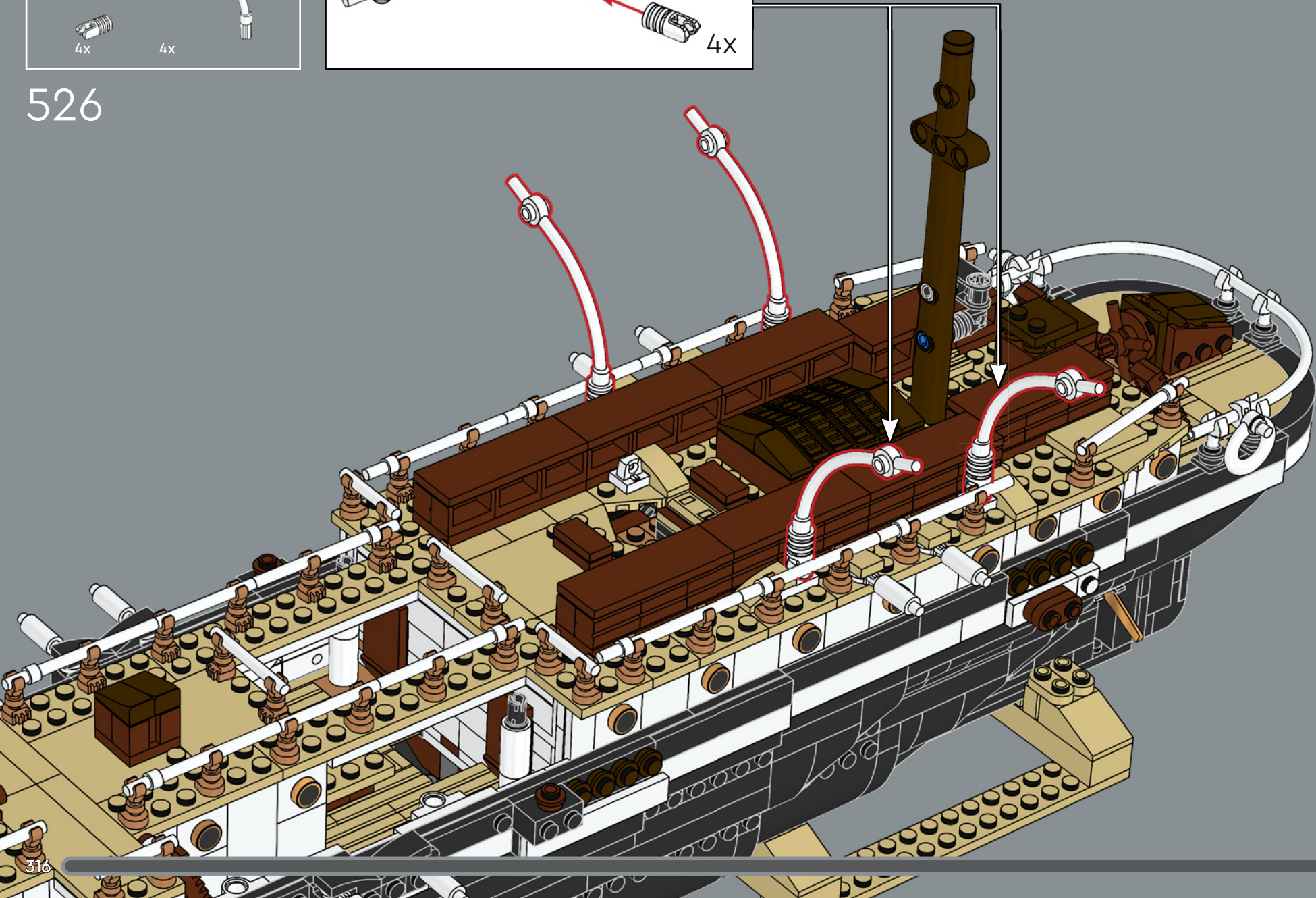

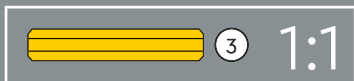
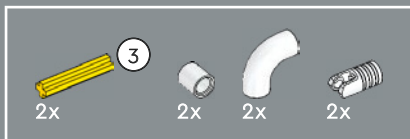

527

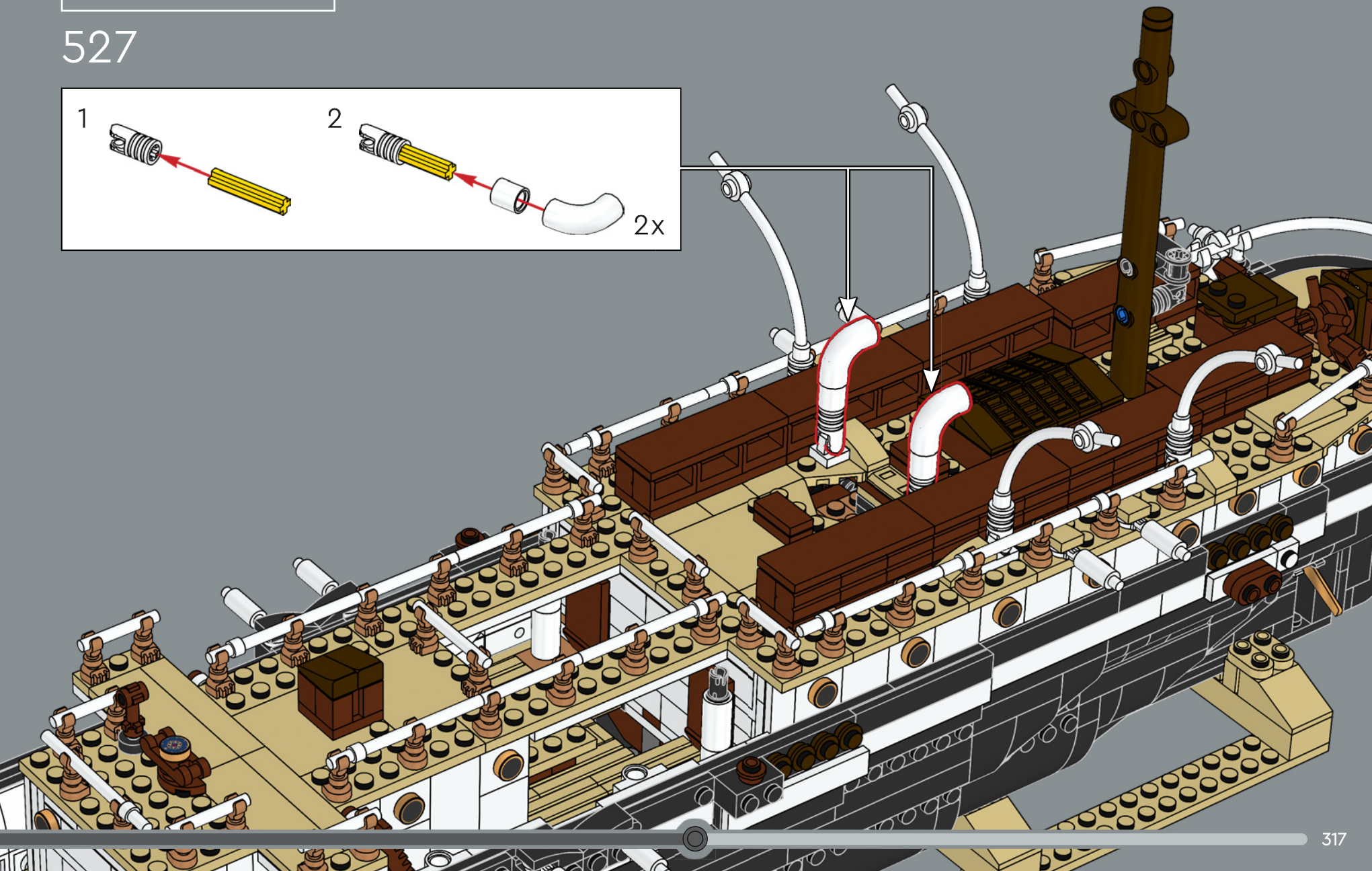
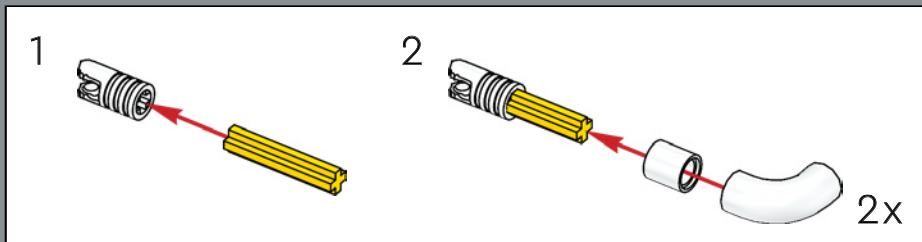

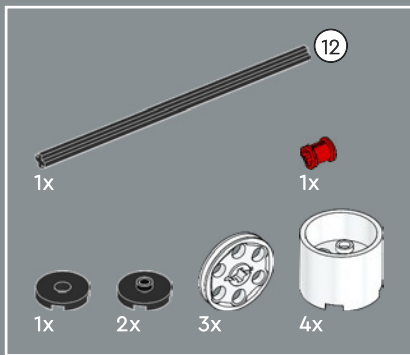

528

1

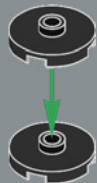

2

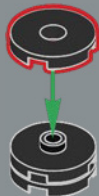

3



4

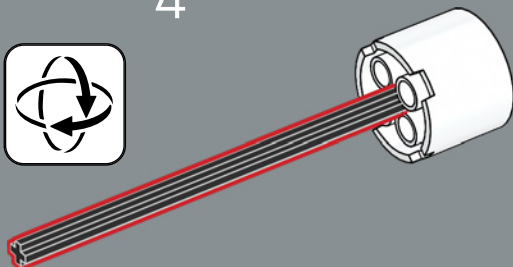

5



6

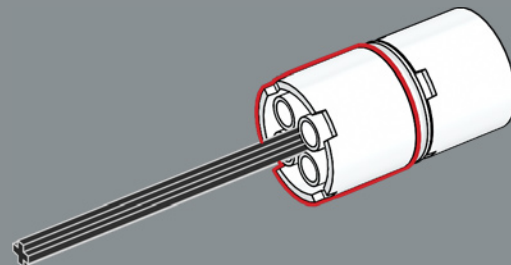

7

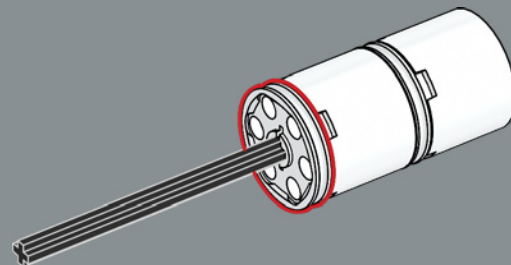

8

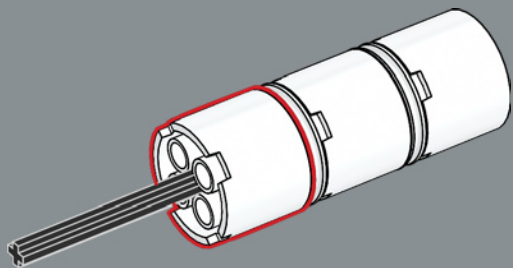

9

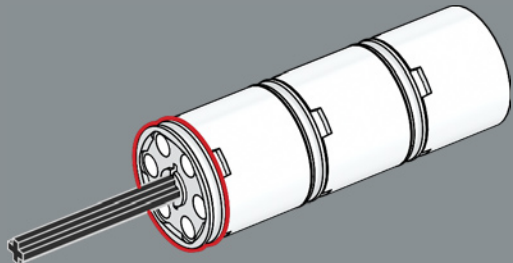

10

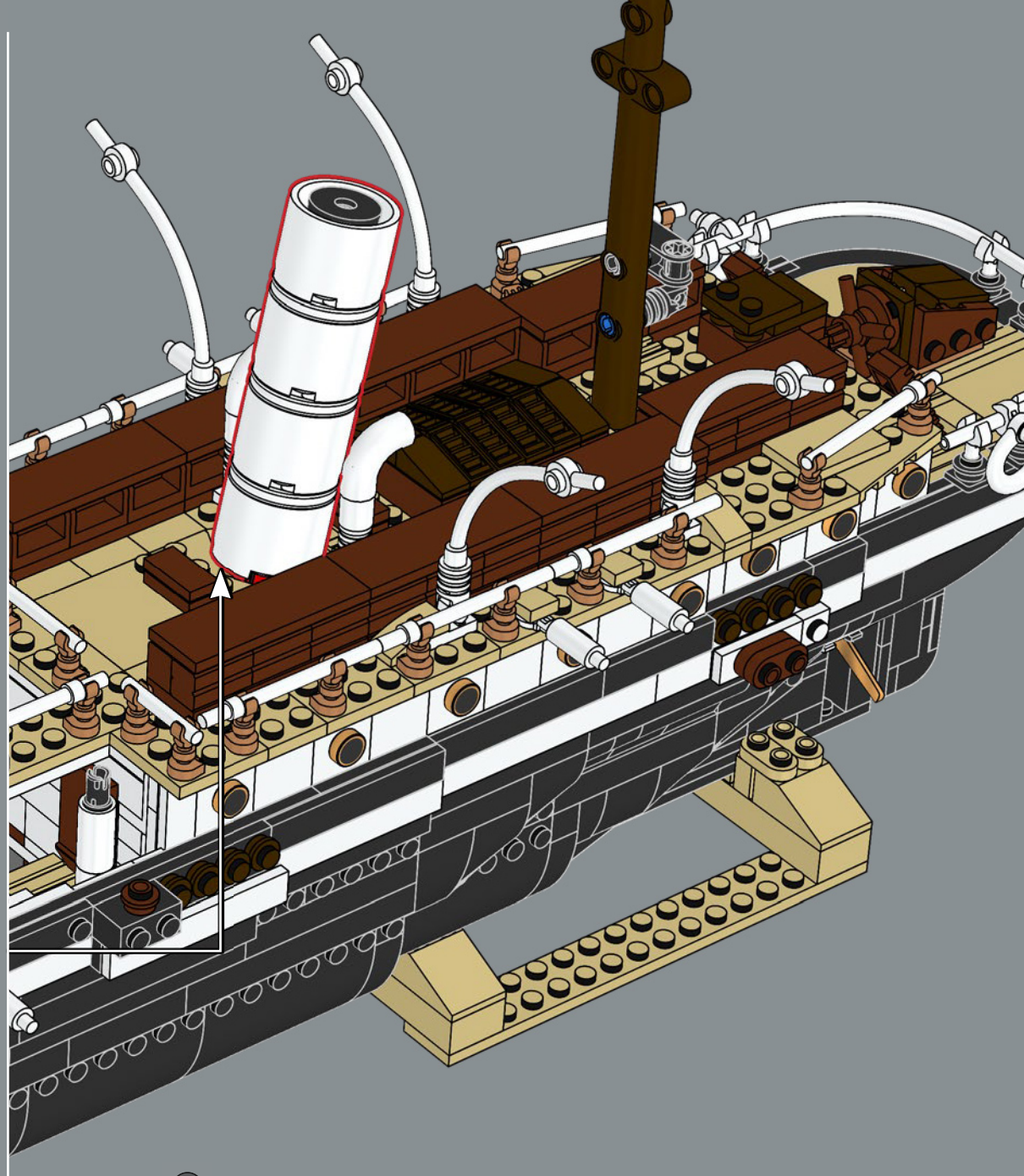
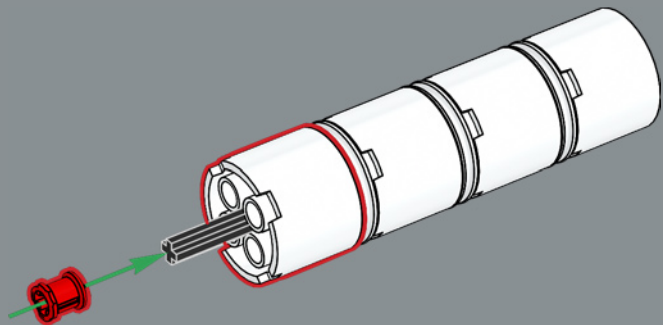

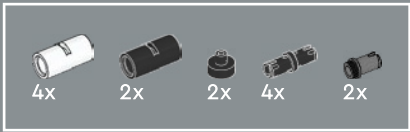

529

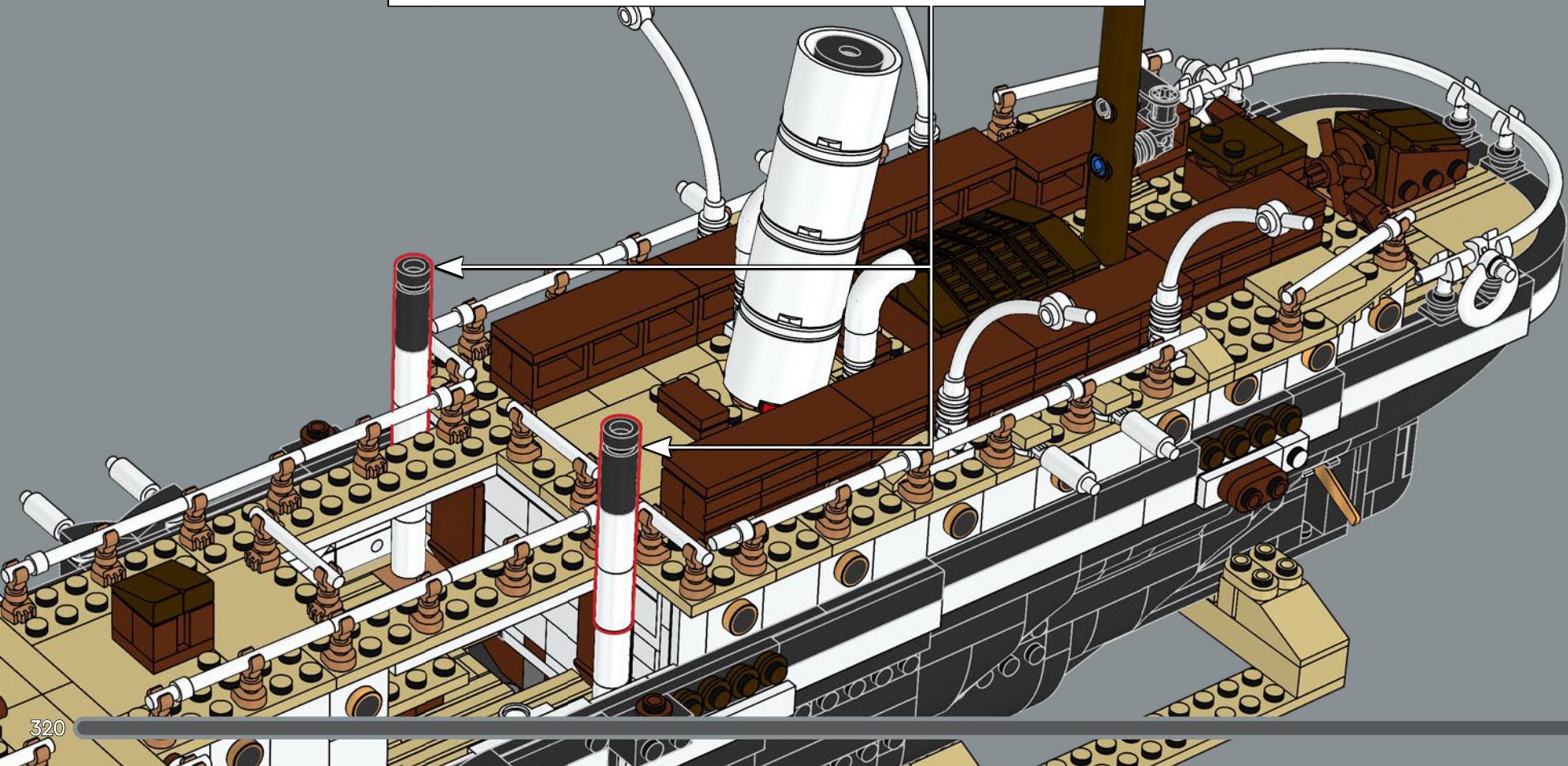
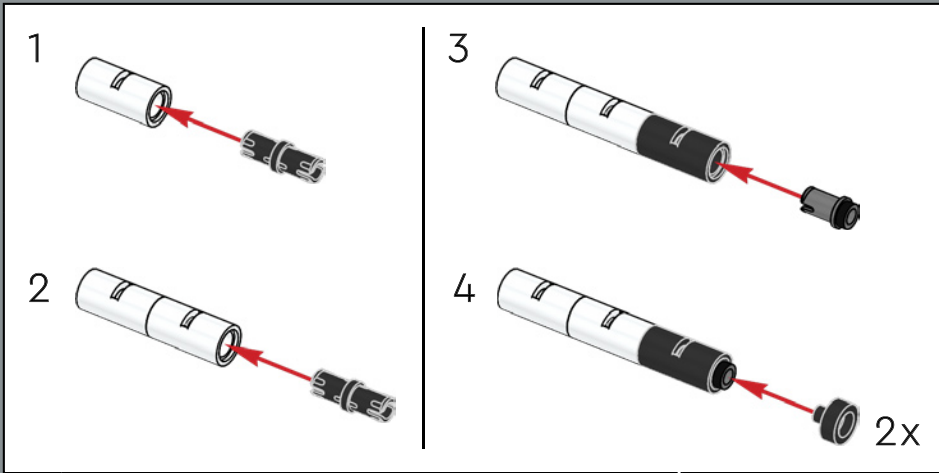

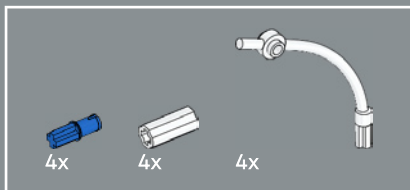

530

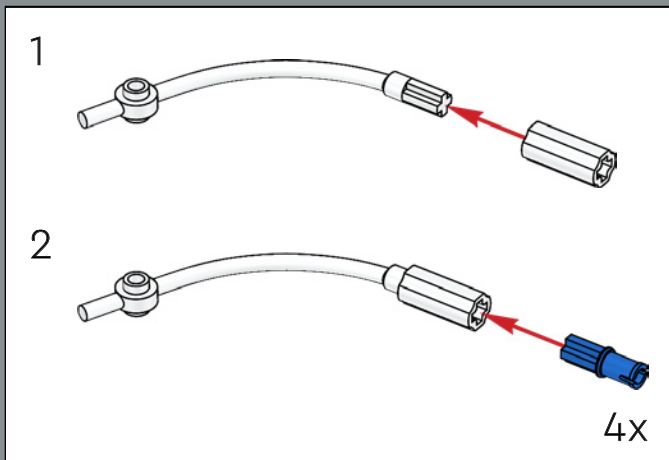

I bracci ricurvi che sostengono le quattro scialuppe di salvataggio sono stati originariamente progettati come elementi porta-minifigure LEGO®.

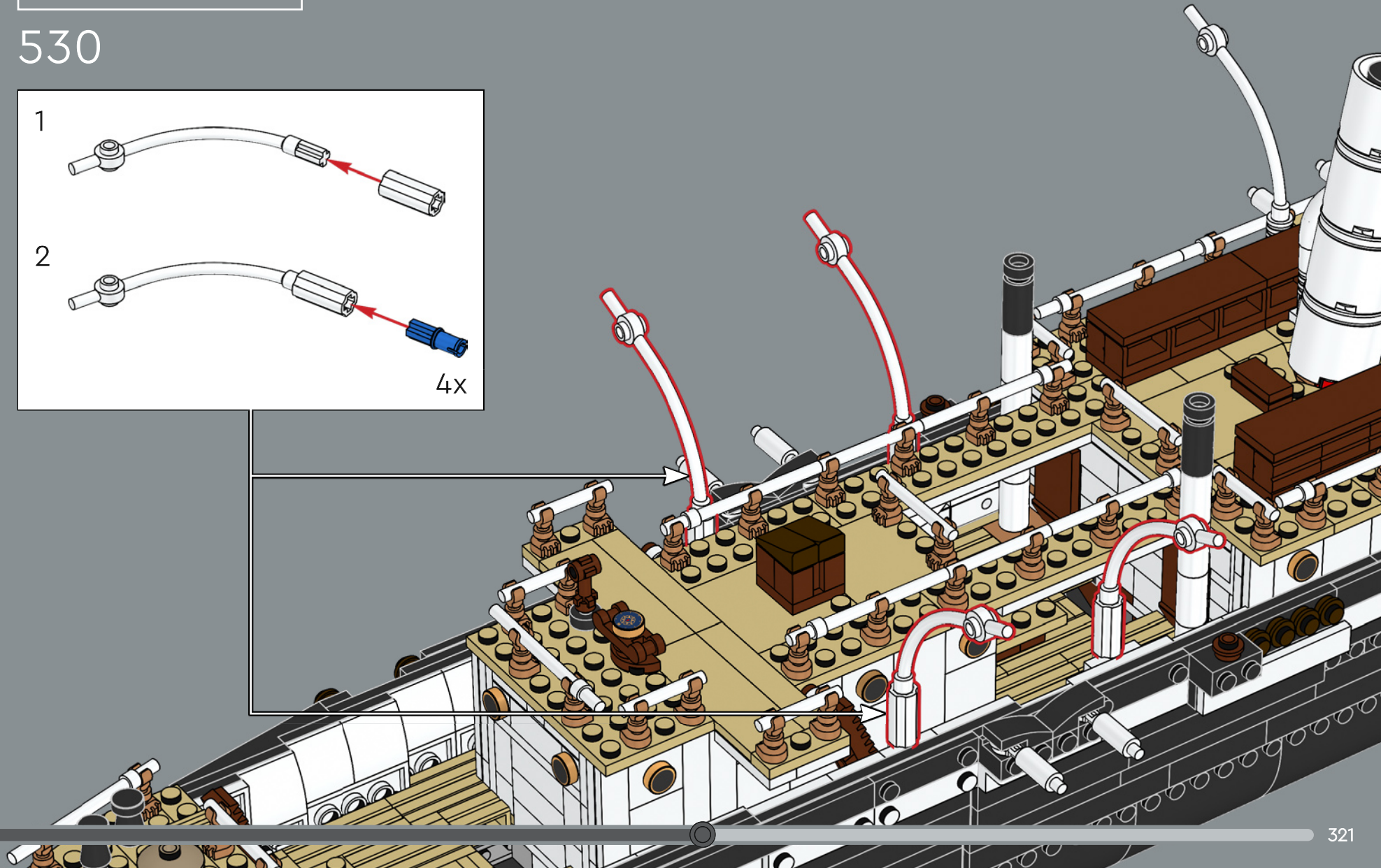

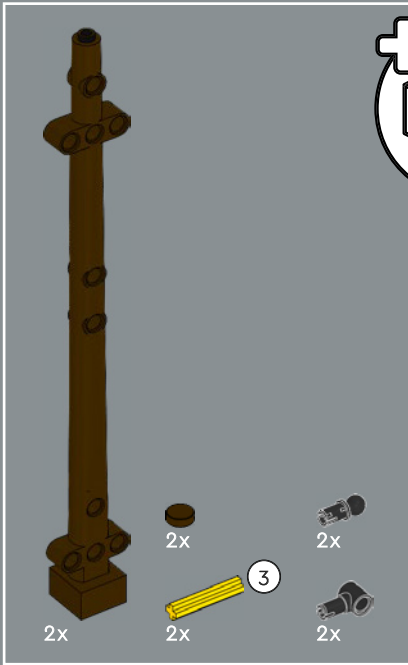
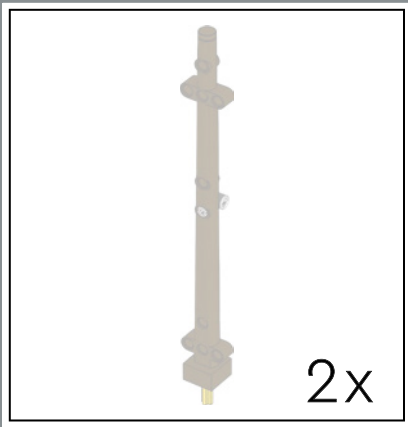

531

1



2

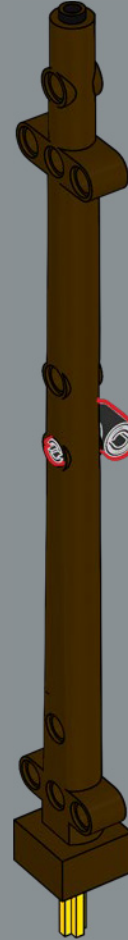

3



2x

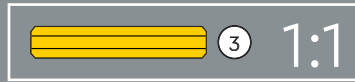

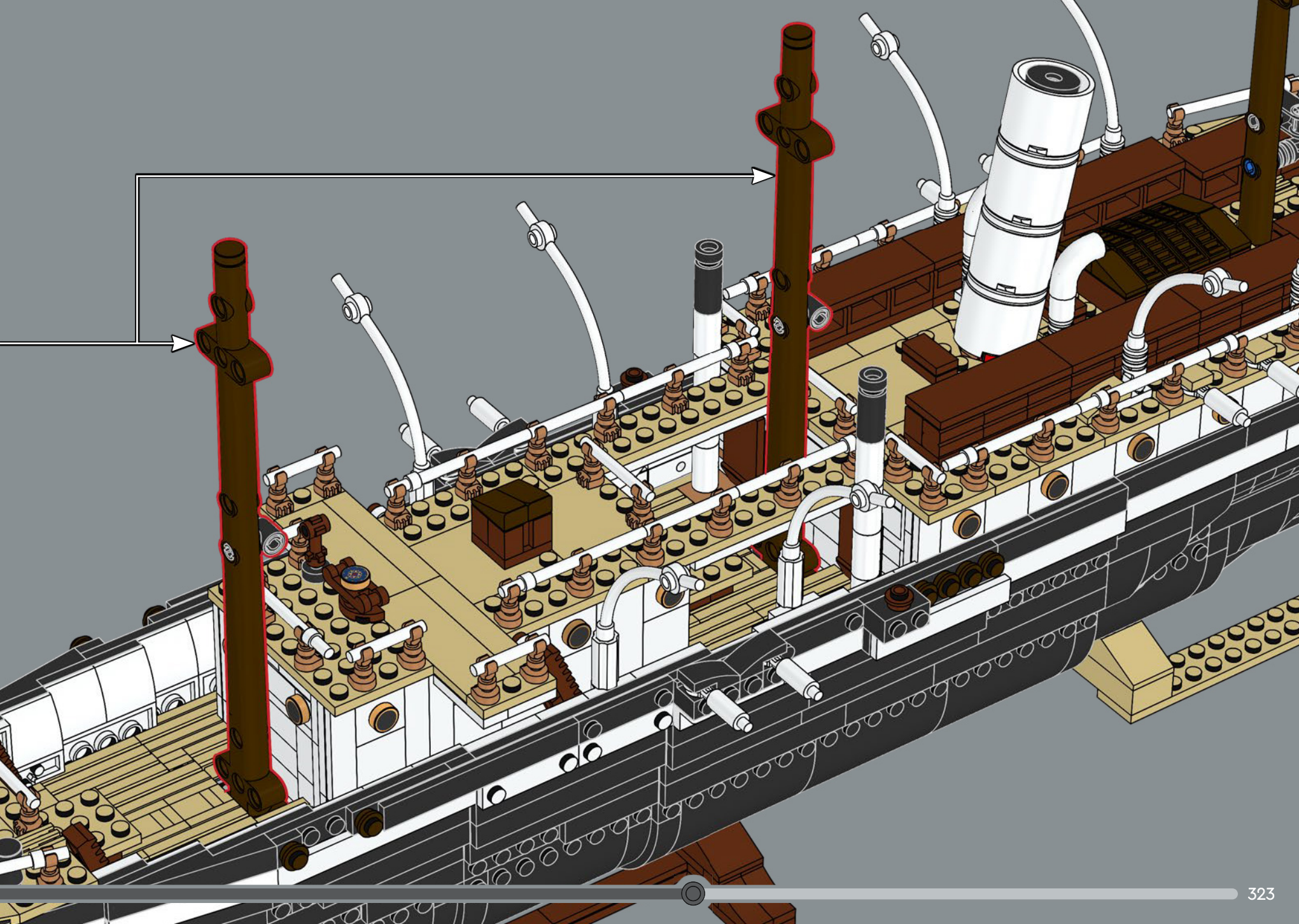

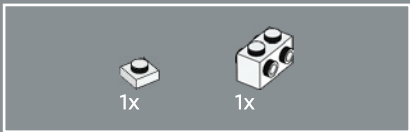
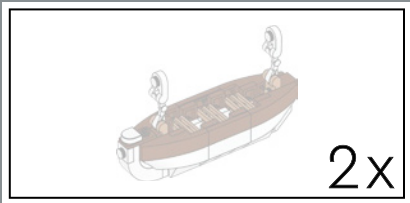

532

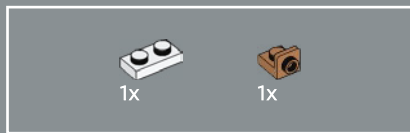
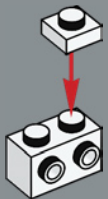

533

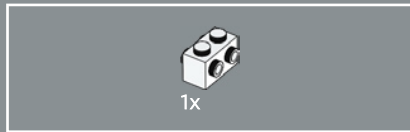
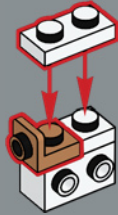

534

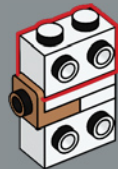

535

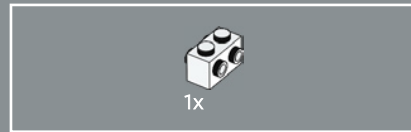

536

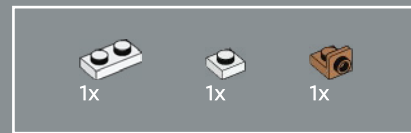
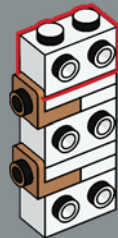

537

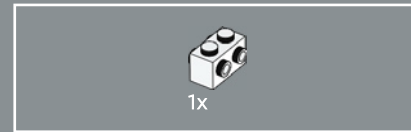

538



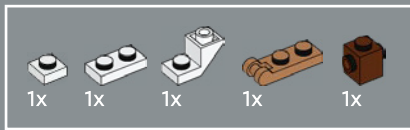

539

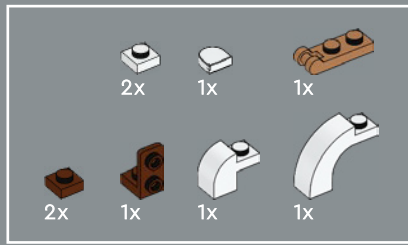
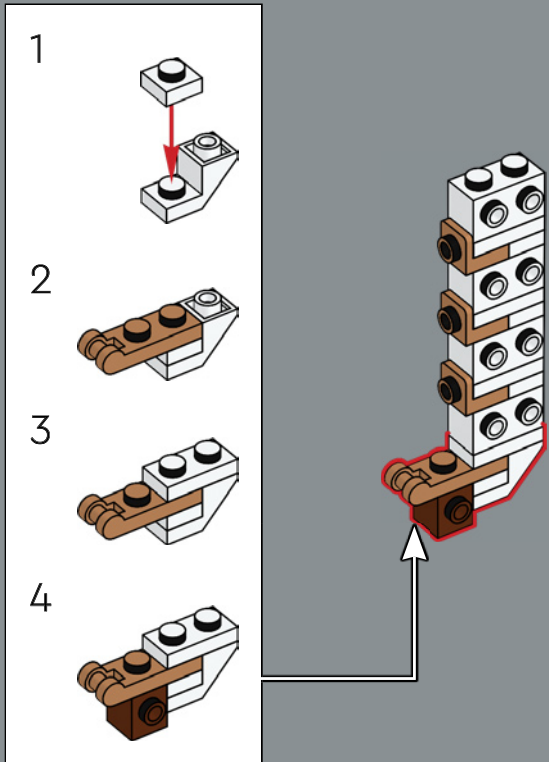

540

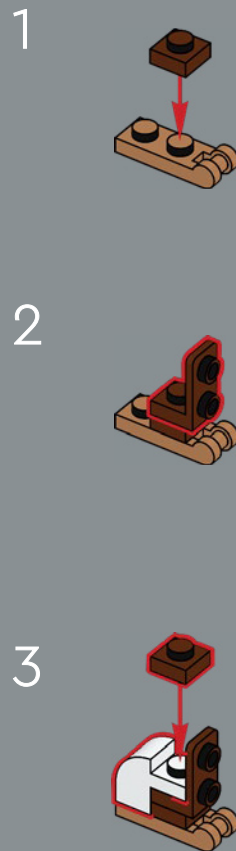

4

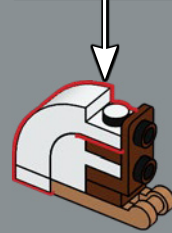
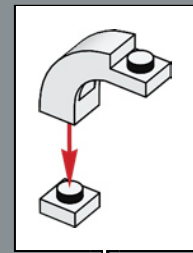

5

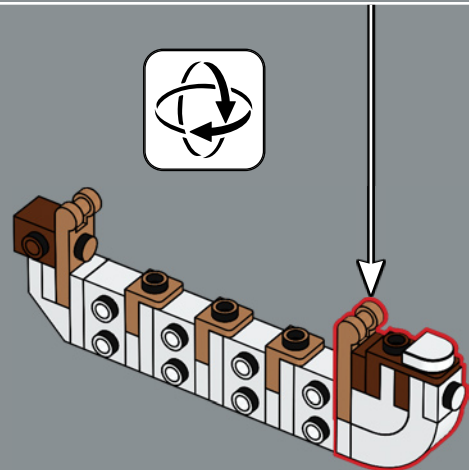
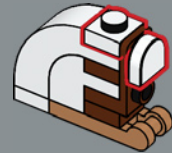

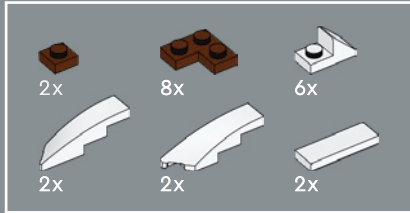
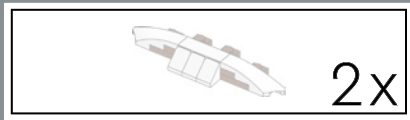

541

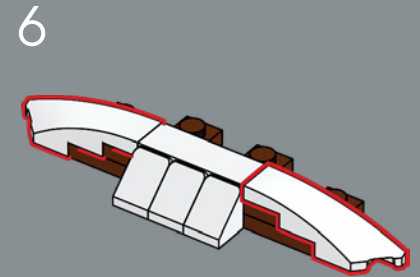
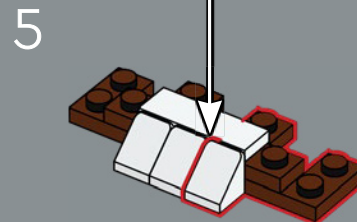
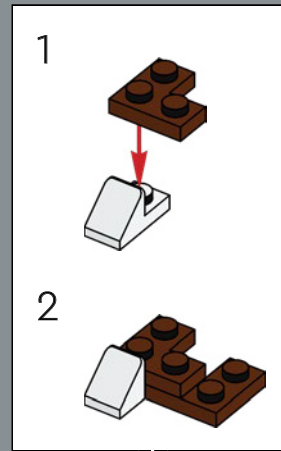
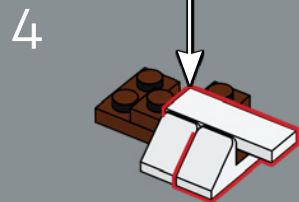
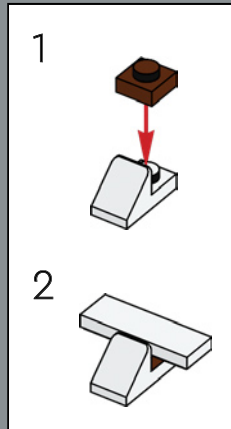
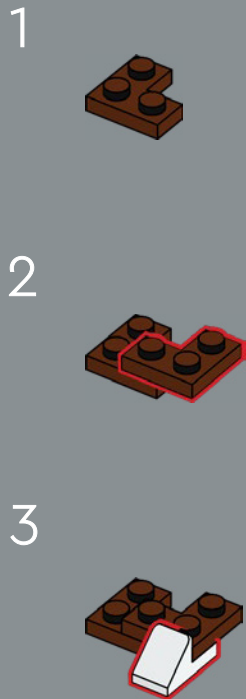

2x

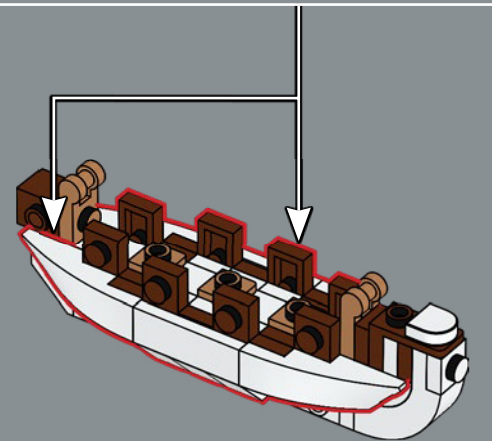



542

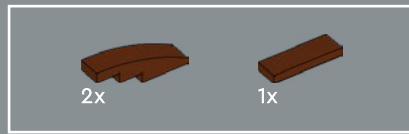
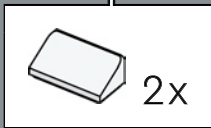
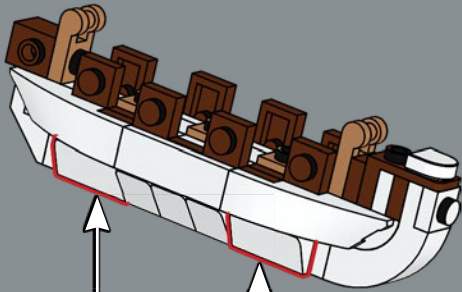

543

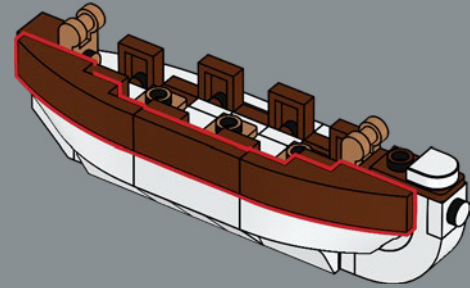

544

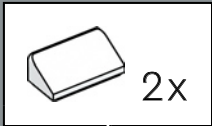
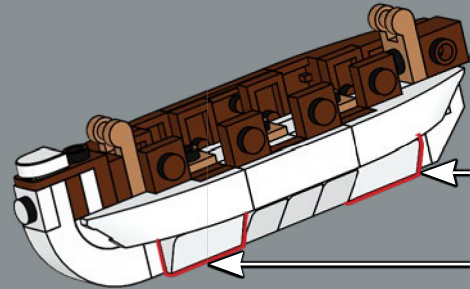



3x

545

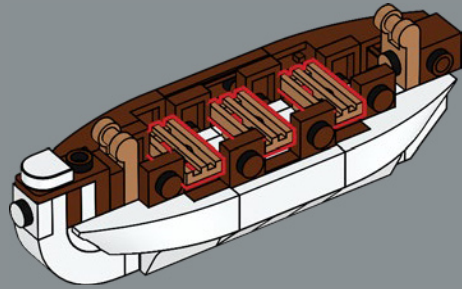

2x

1x

546

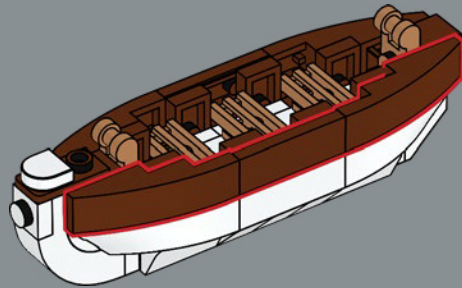

2x

547

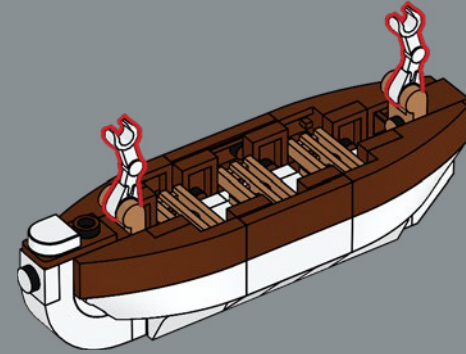

2x

548

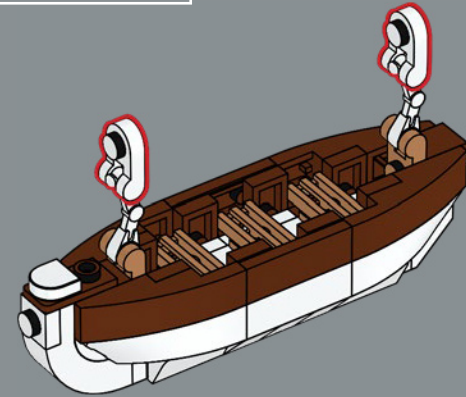

2x

549

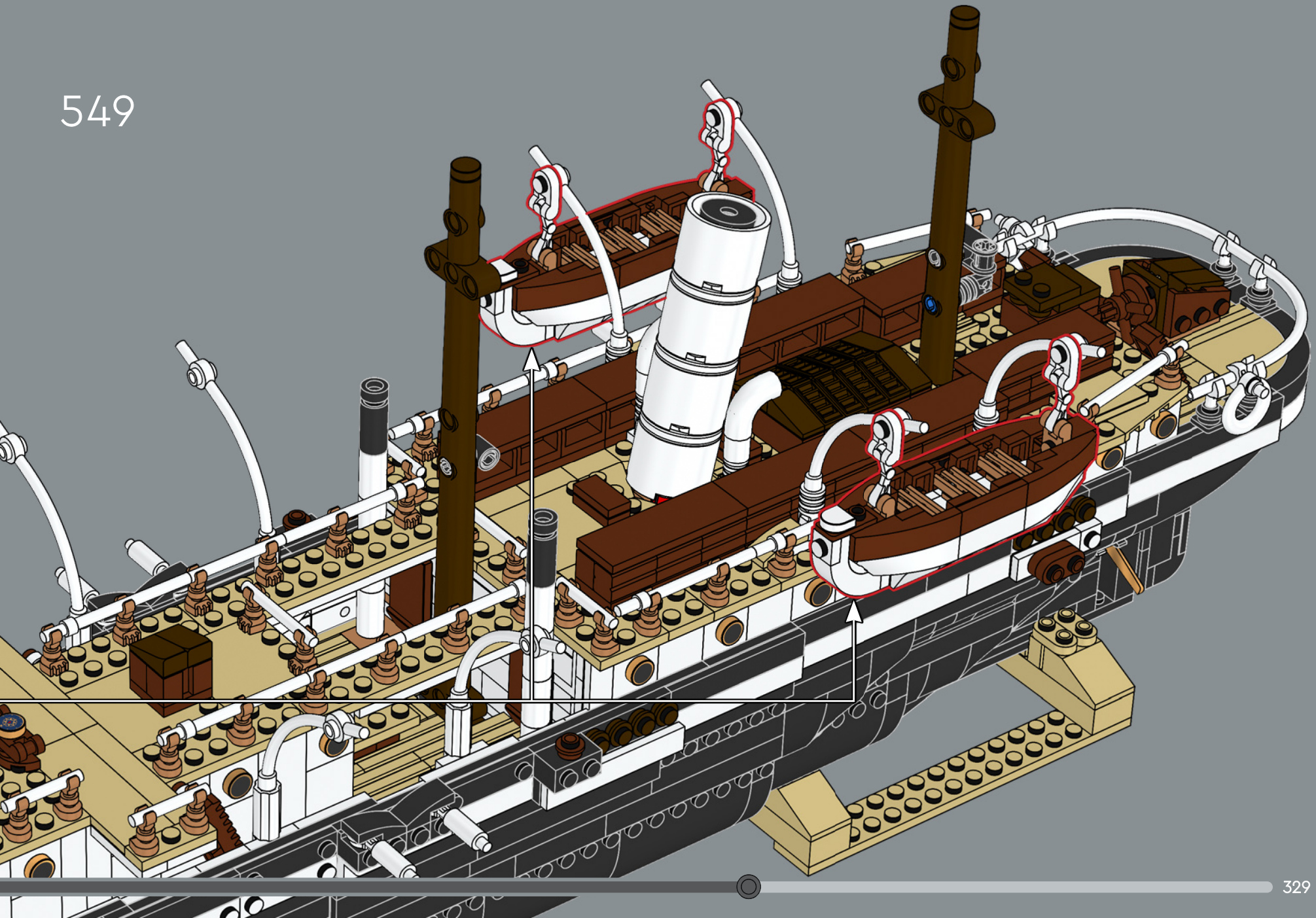

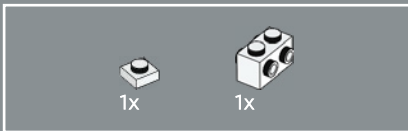
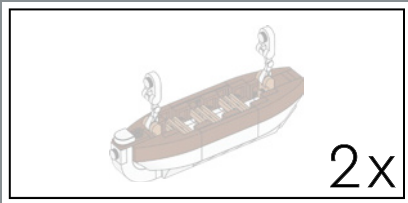

550

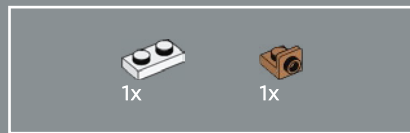
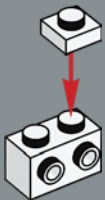

551

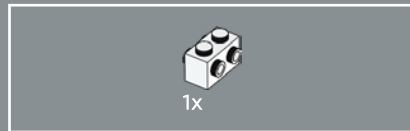
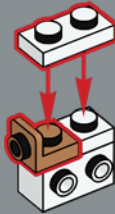

552

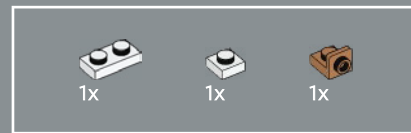

553

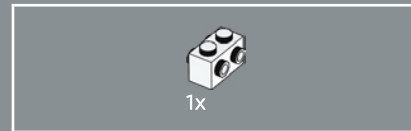
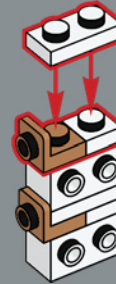

554

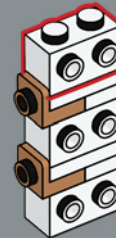

555

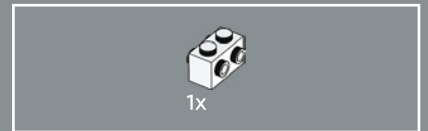

556

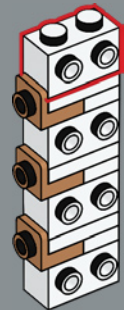

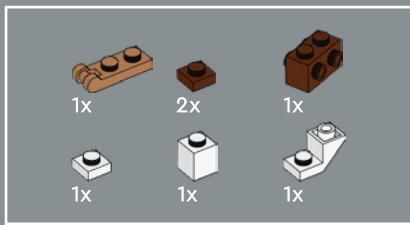

557

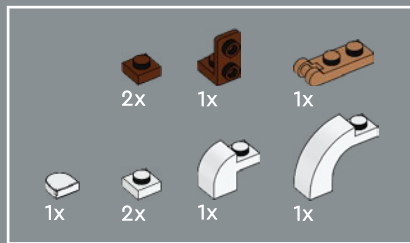
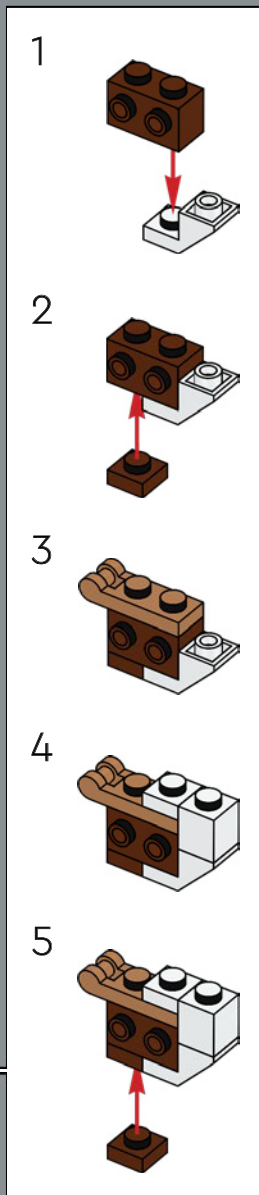
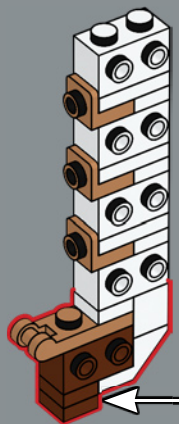

558

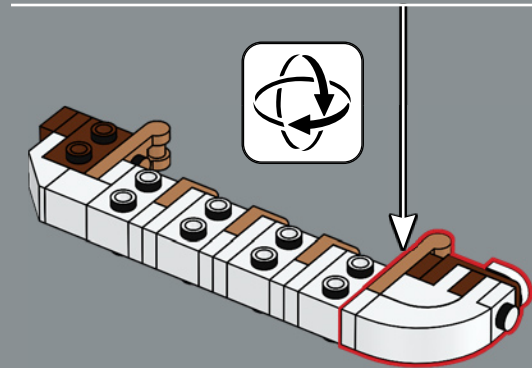
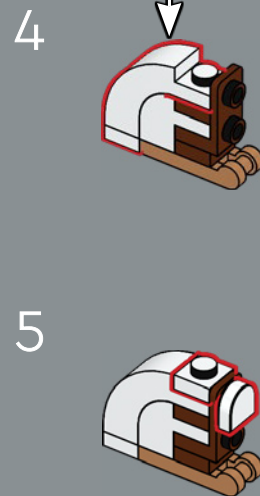
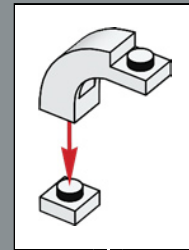
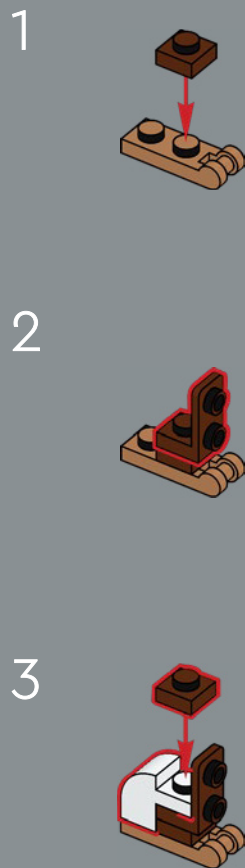

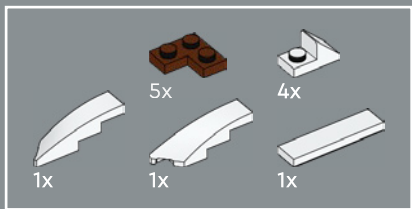

559

1



2



3

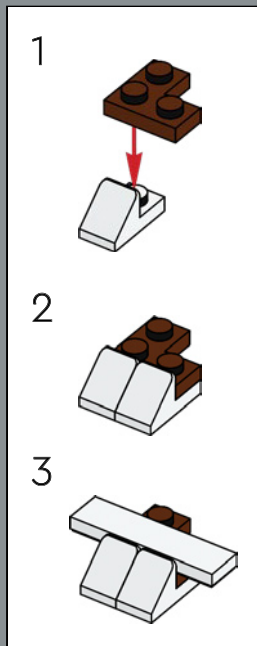

4

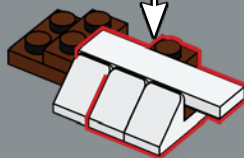

5

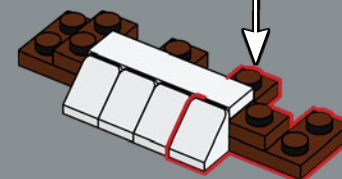
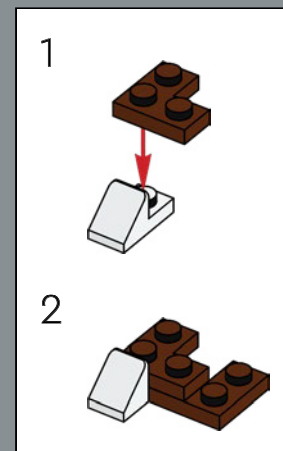

6

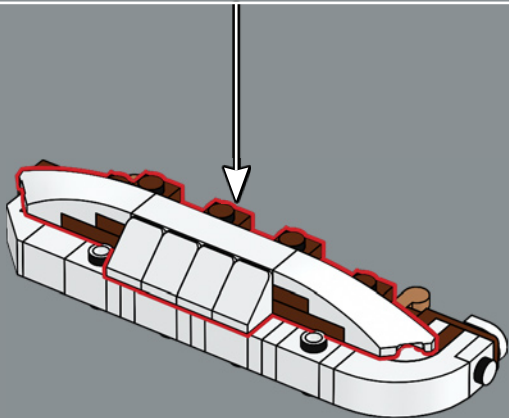
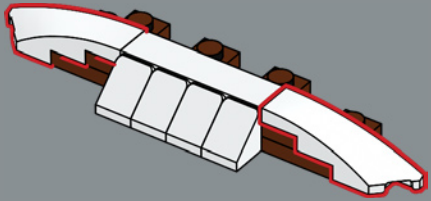

2x

560

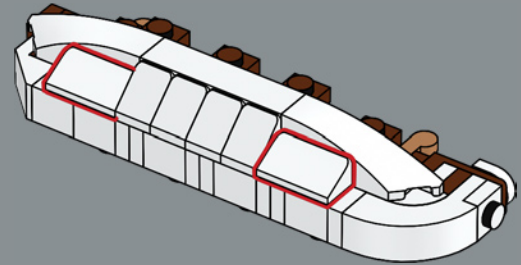

1x

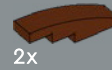

2x

561

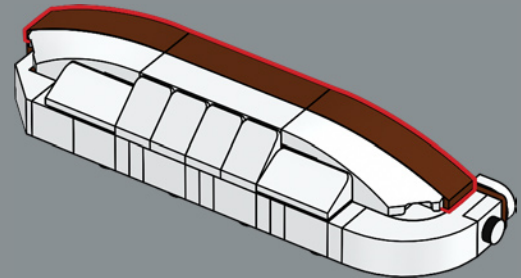

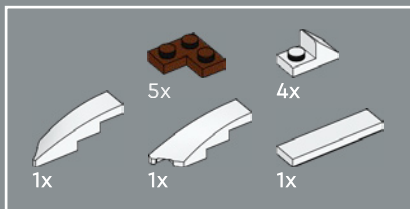

562

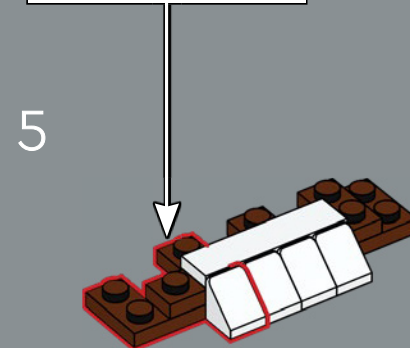
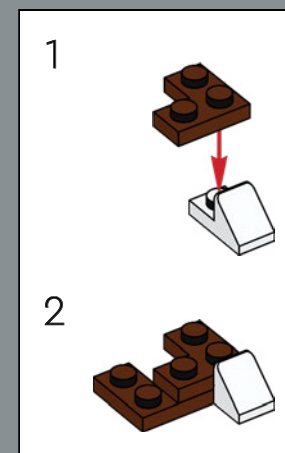
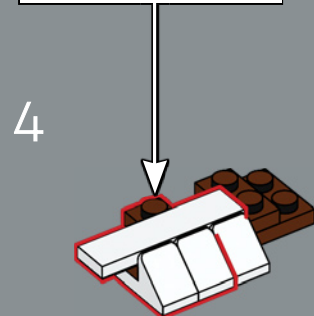
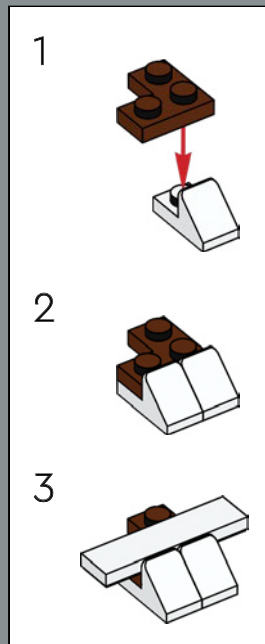
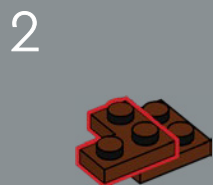
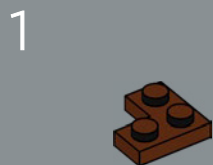

6

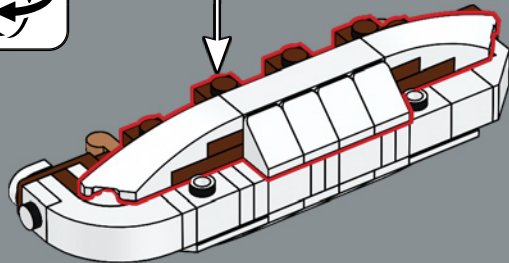
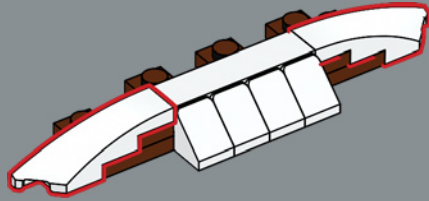

2x

563

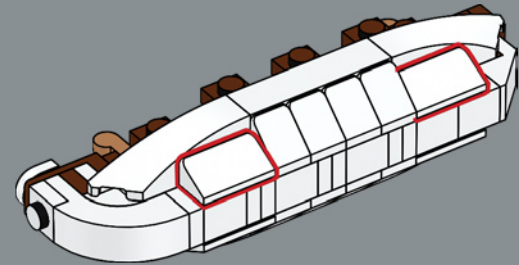



3x

564

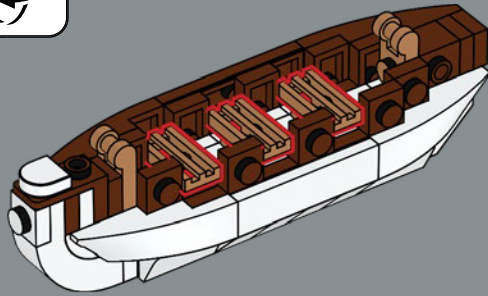

1x



2x

565

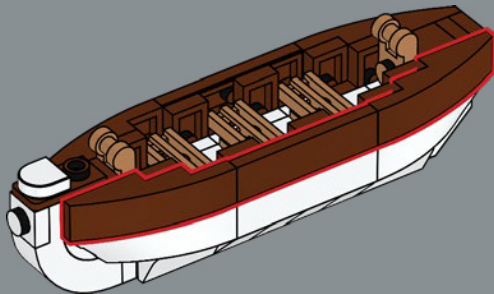

2x

566

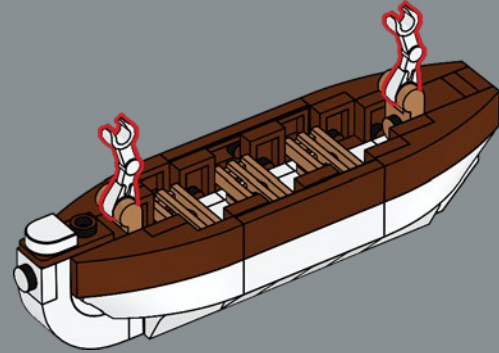

2x

567

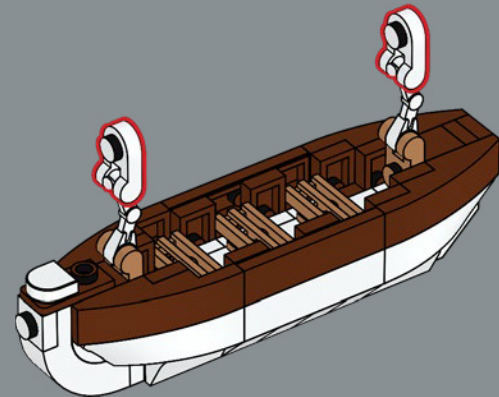

2x

568

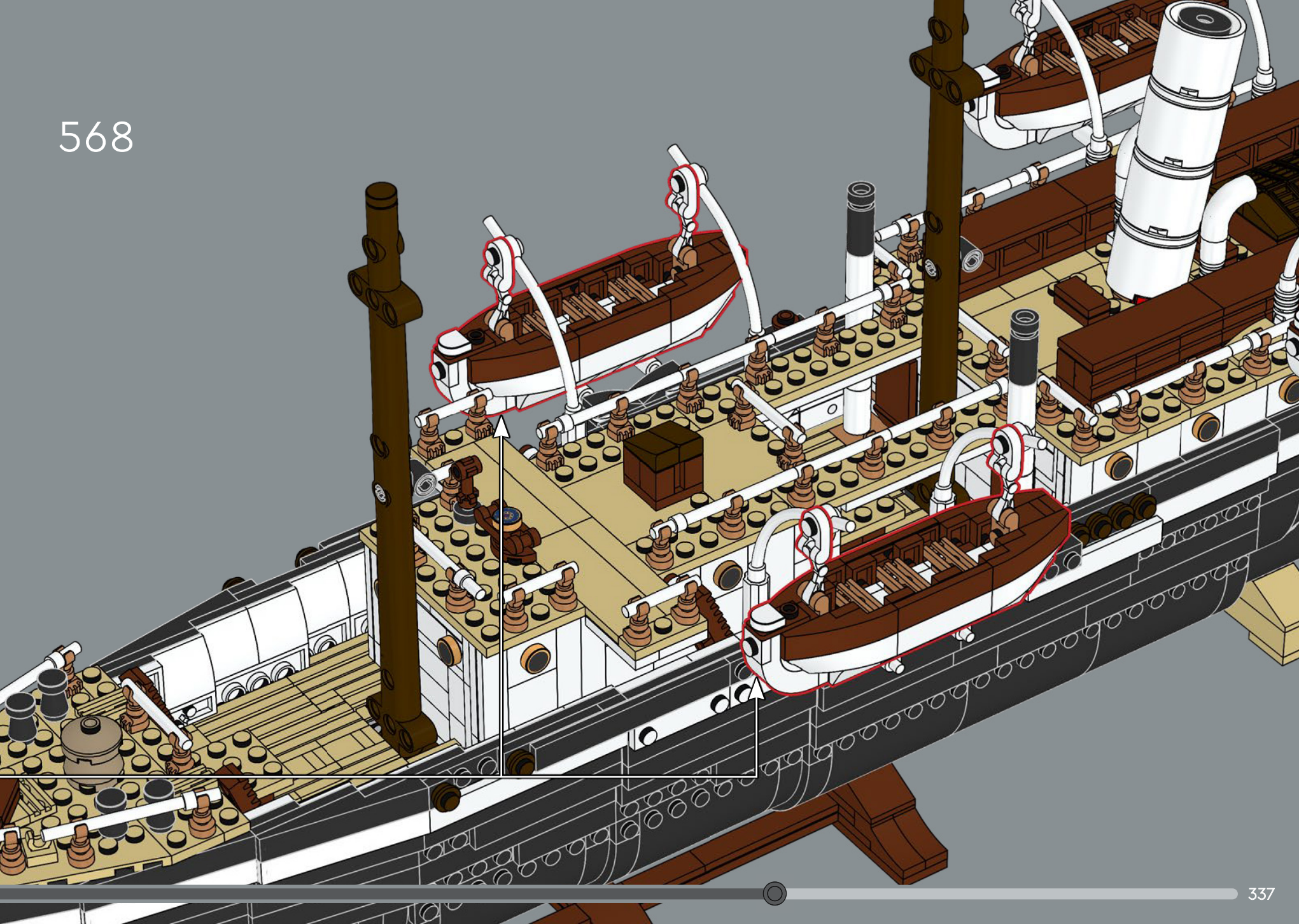

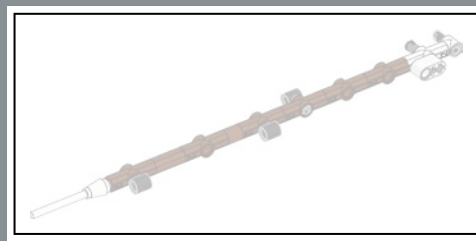

569

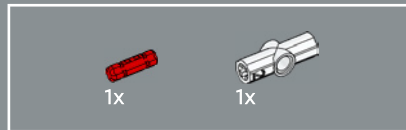
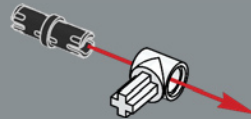

570

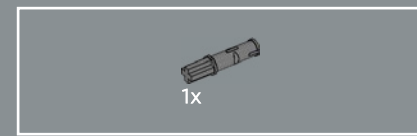
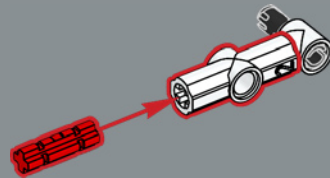

571

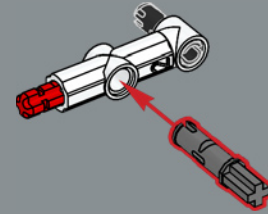

572

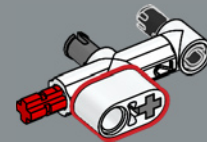

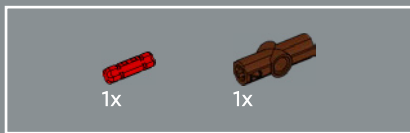

573

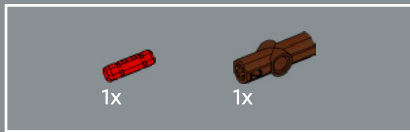
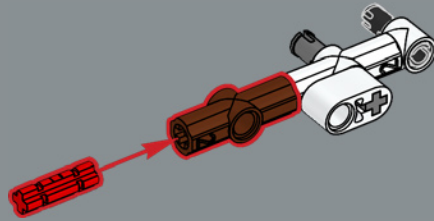

574

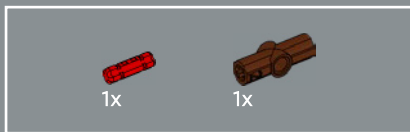
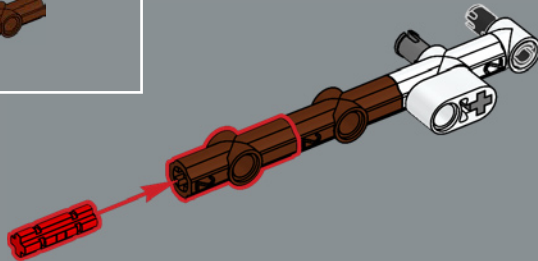

575

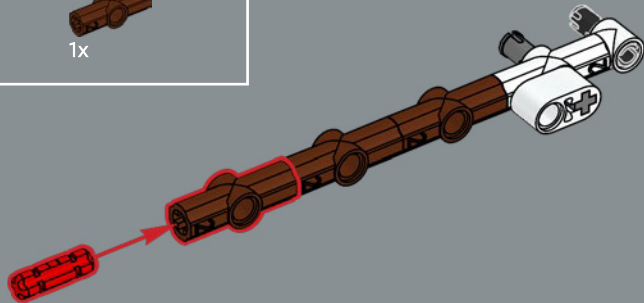

576

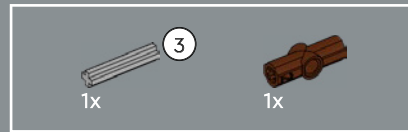
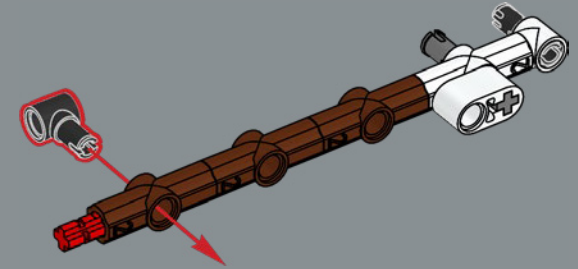

577

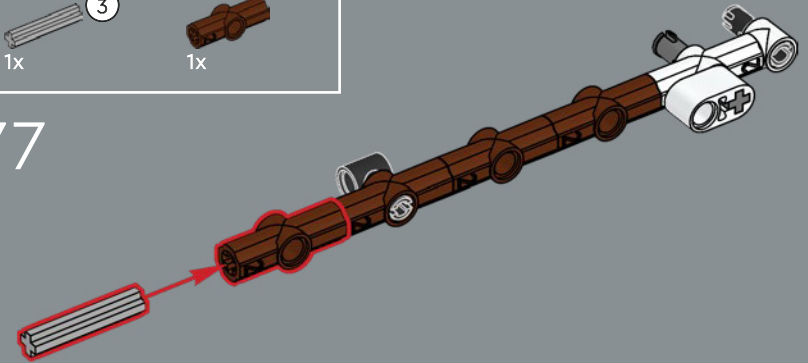

578

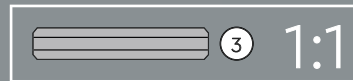
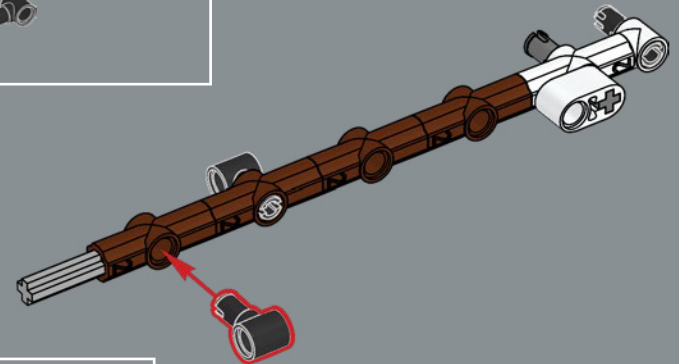

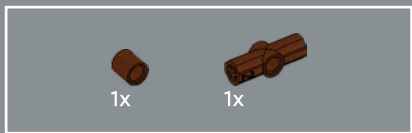

579

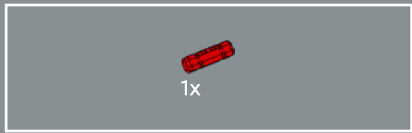
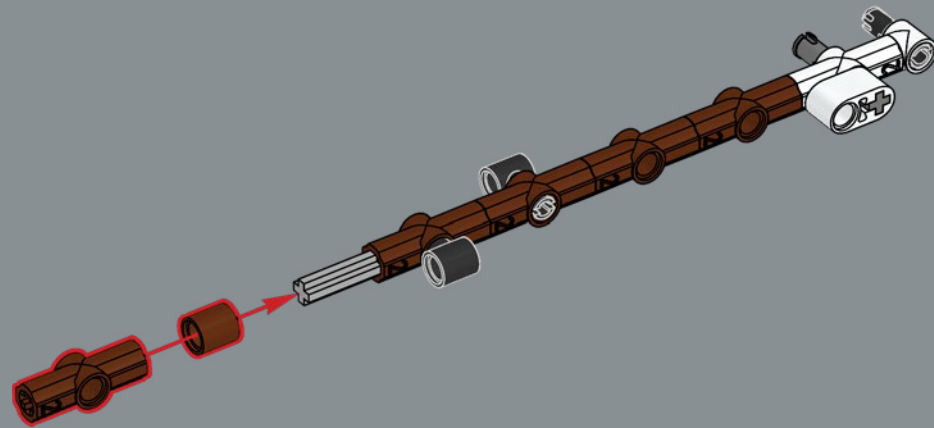

580

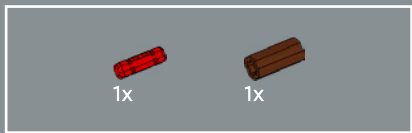
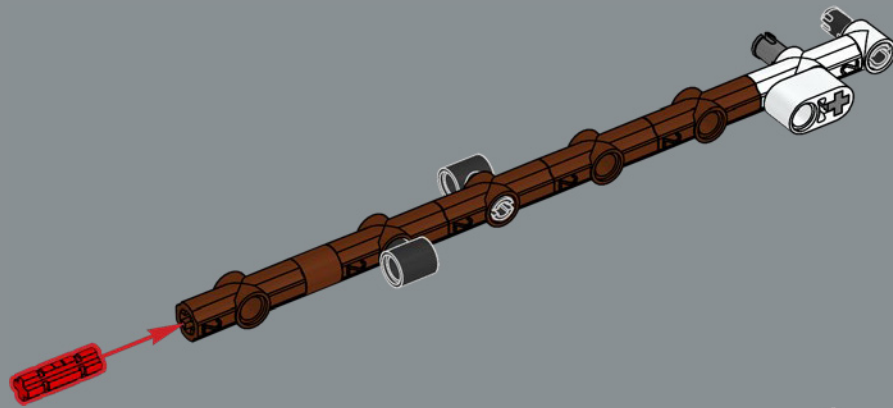

581

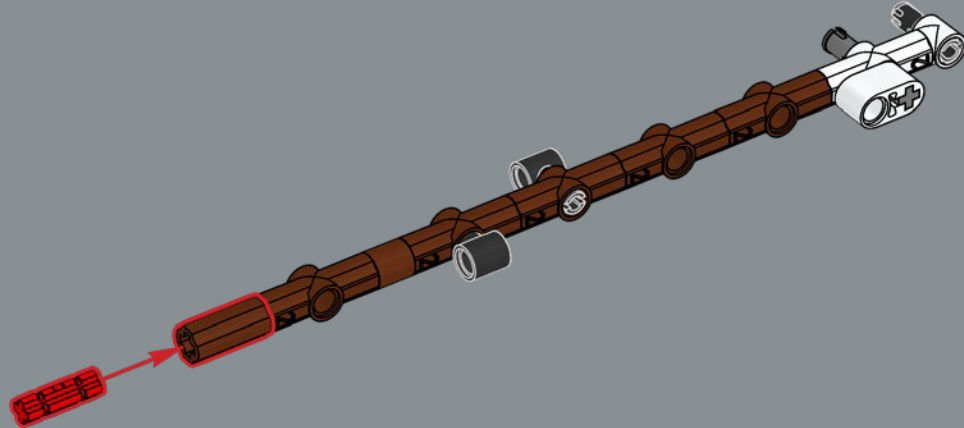



582

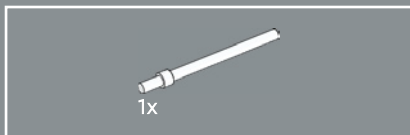
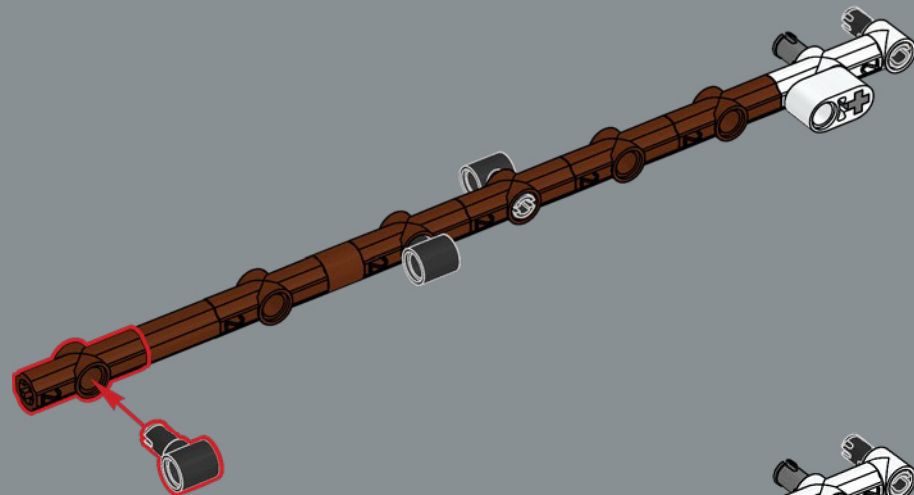

583

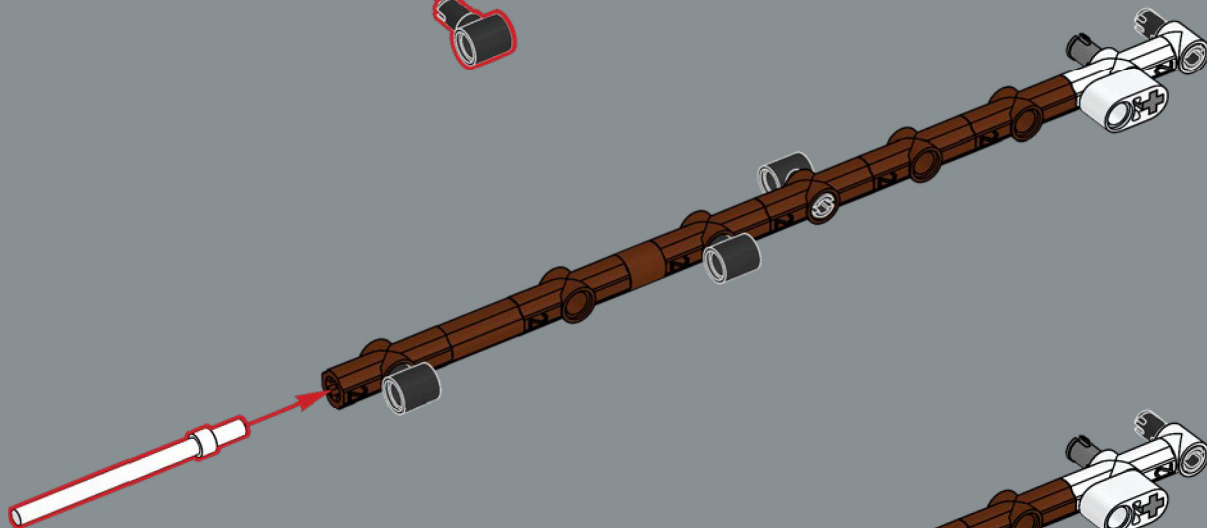

584

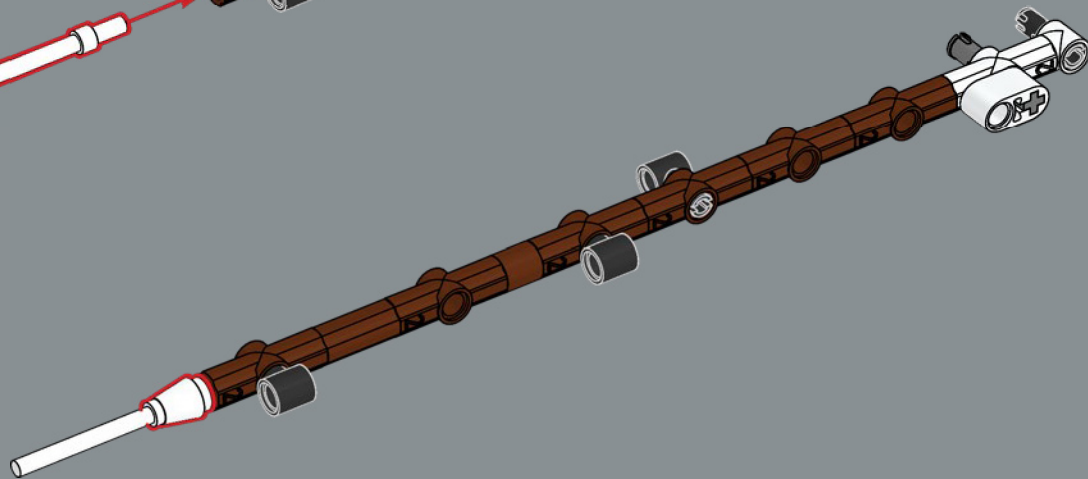

585

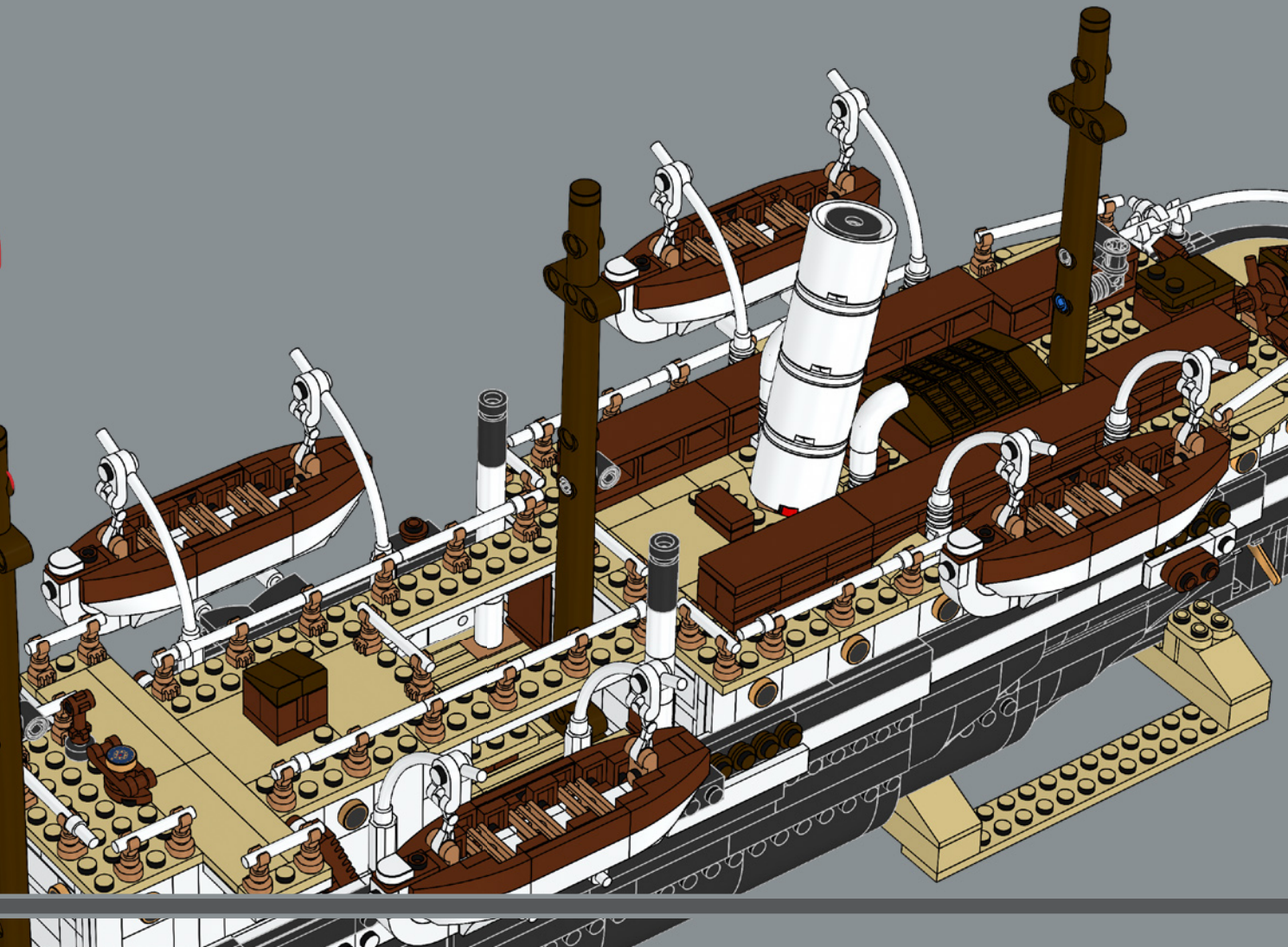

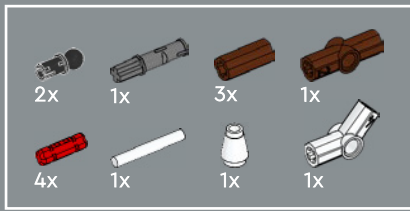

586

1

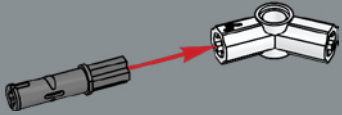

2

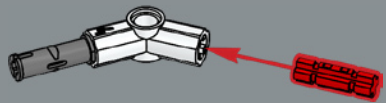

3

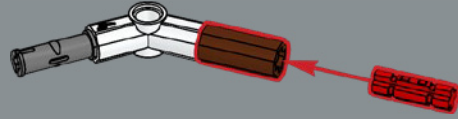

4



5

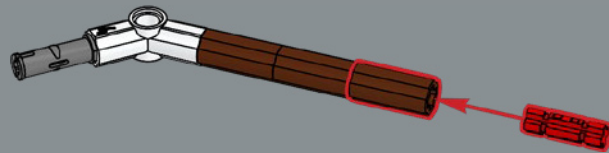

6

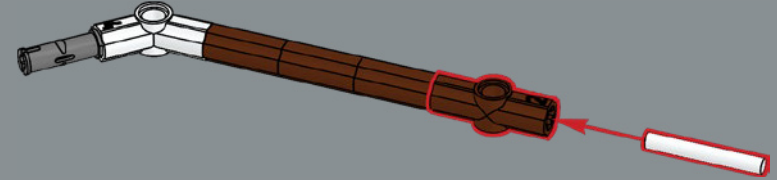

7

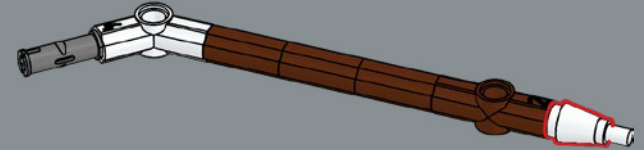

8

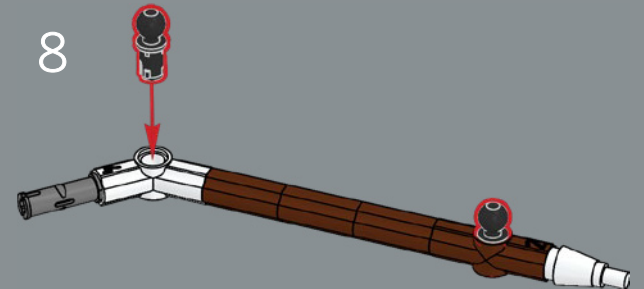

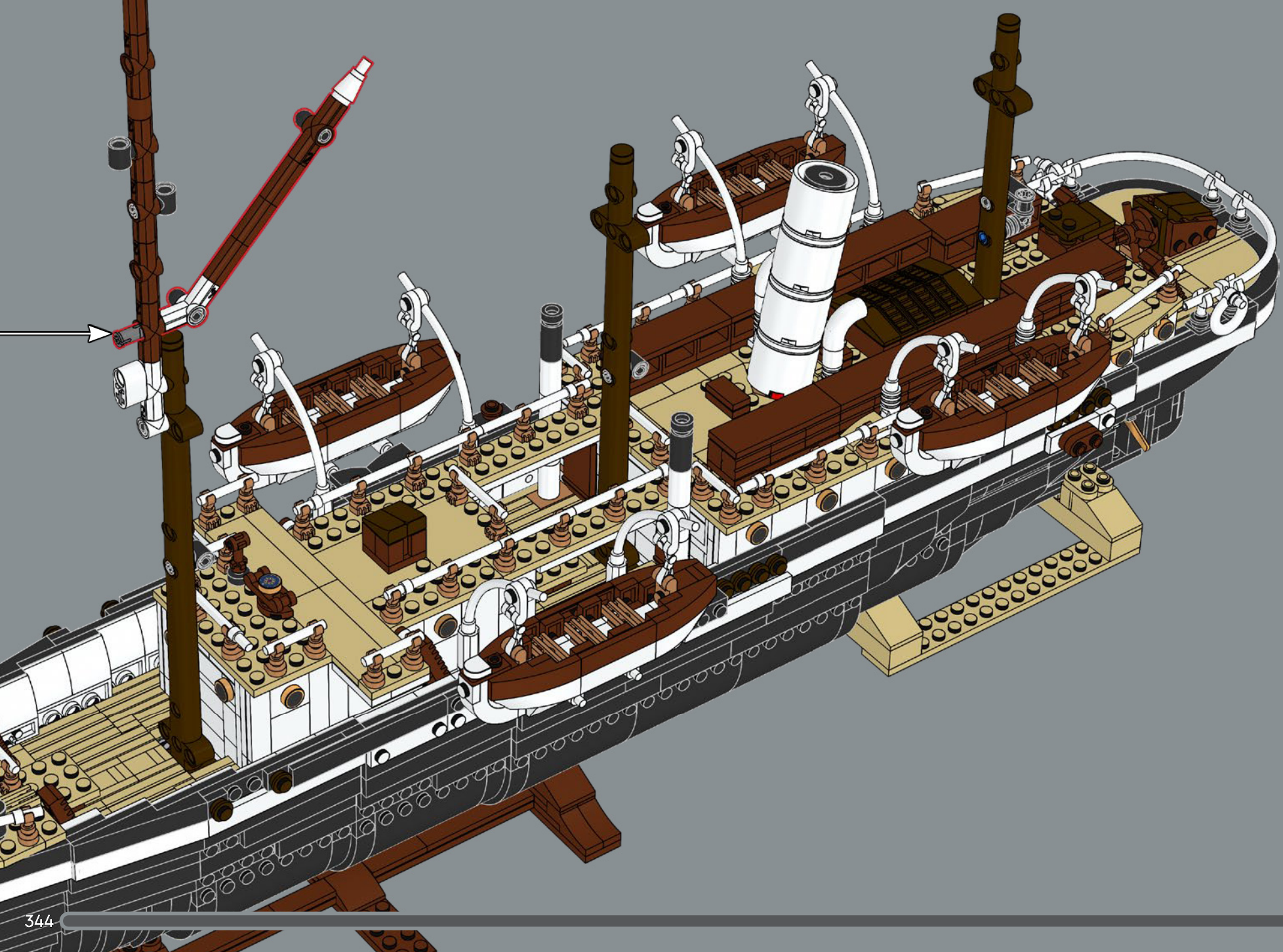

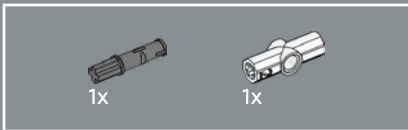
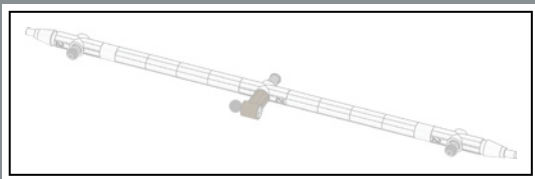

587

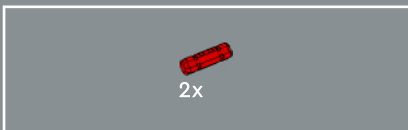
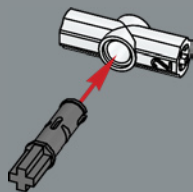

588

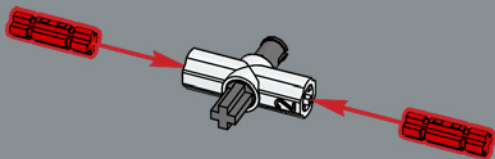

589

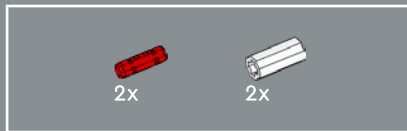
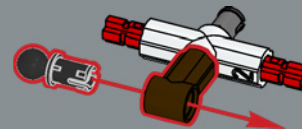

590

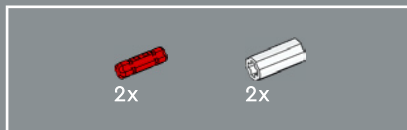
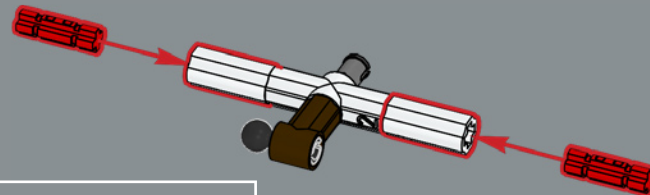

591

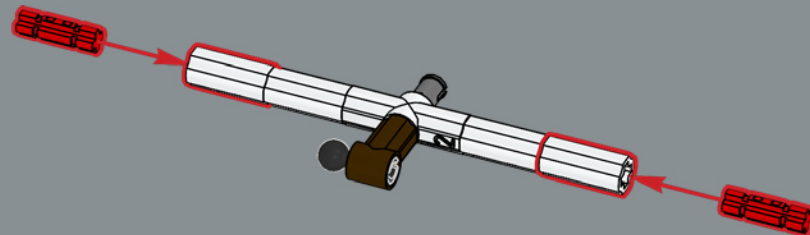

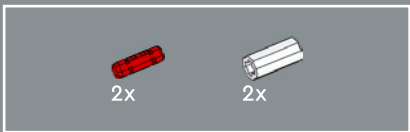

592

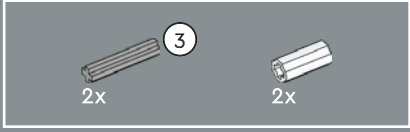
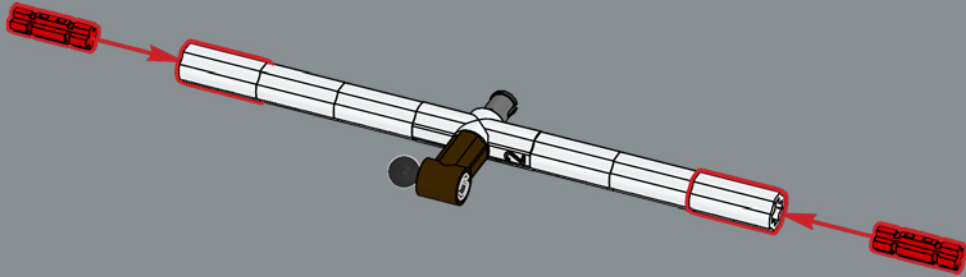

593

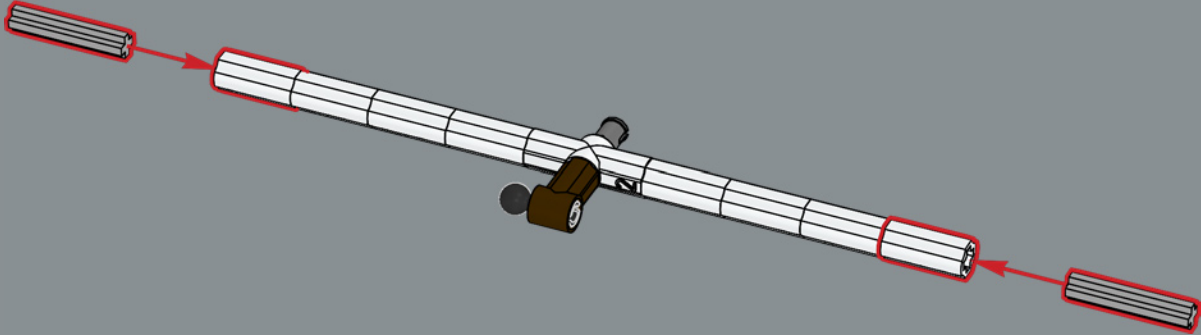

594

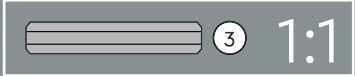
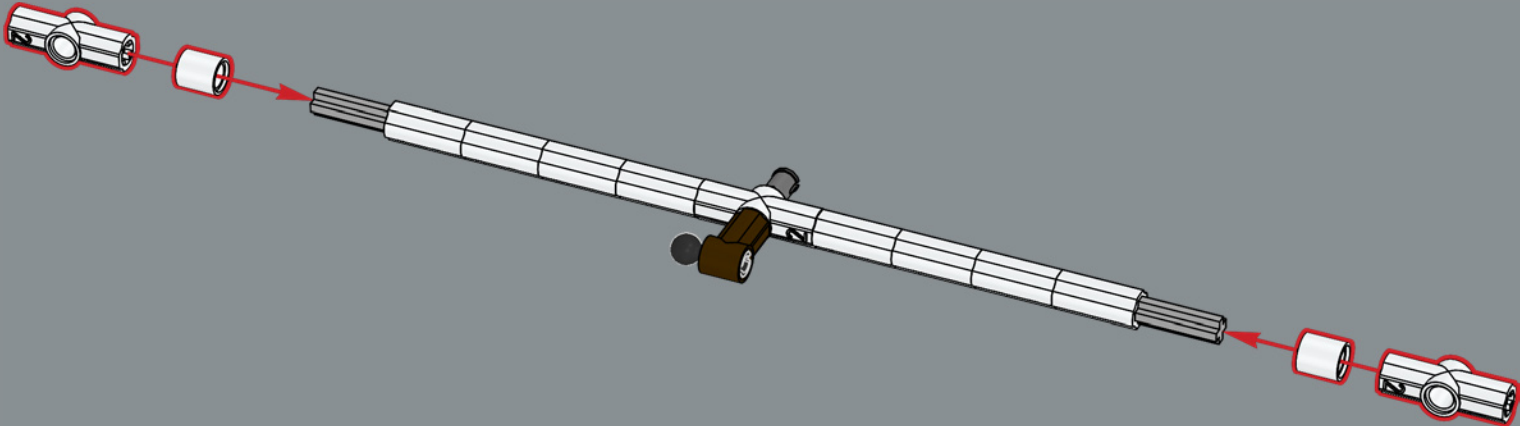



595

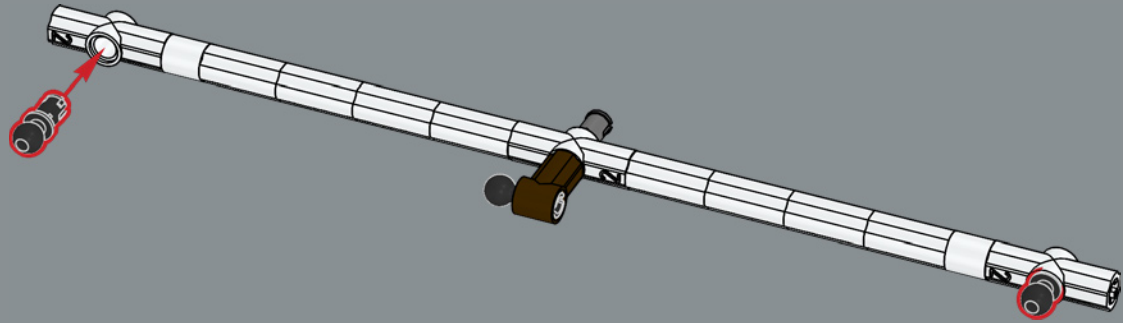

596

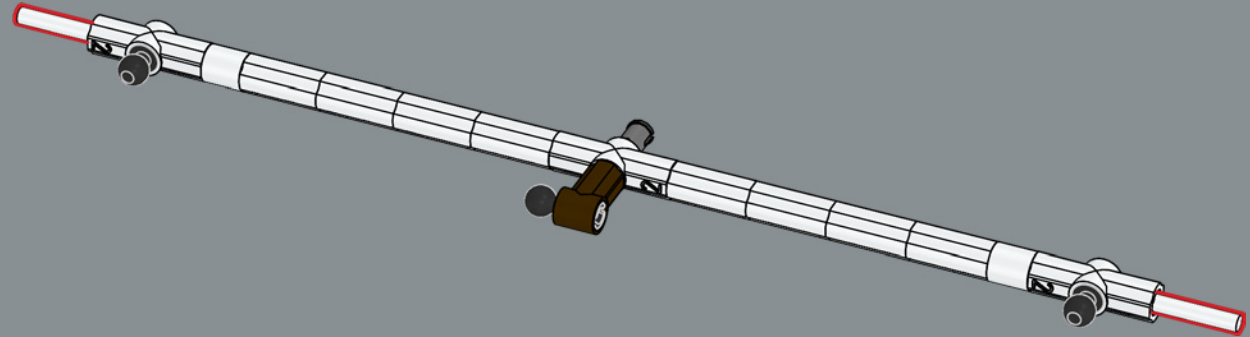

597

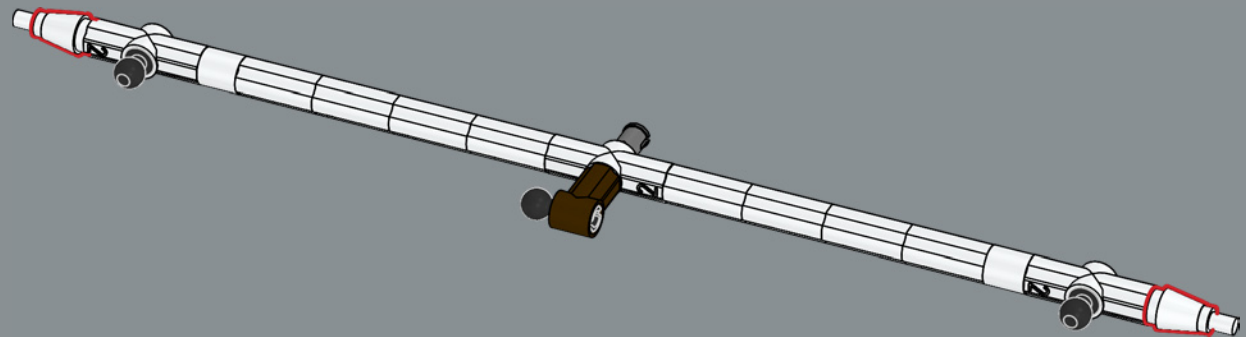

598

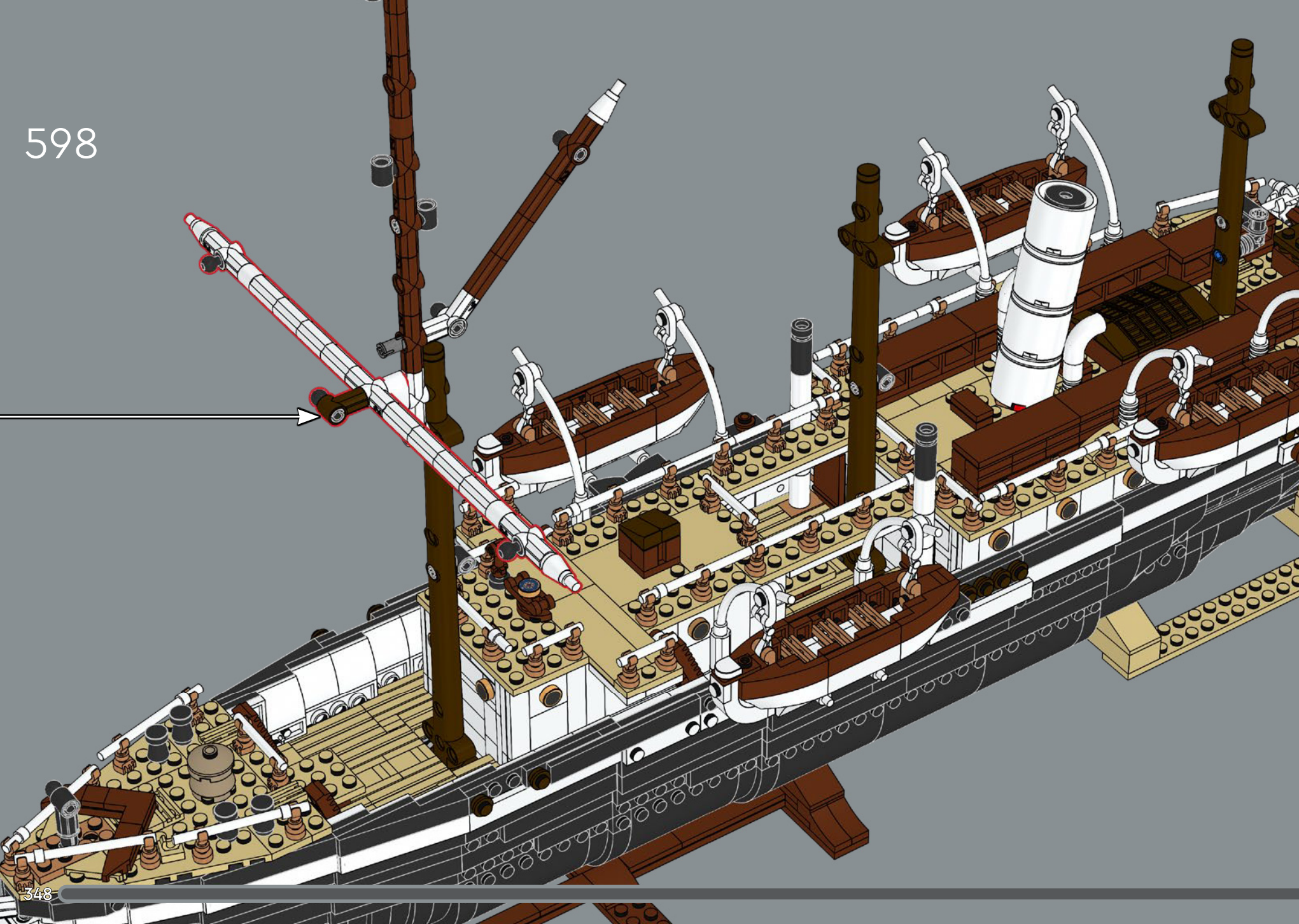



599

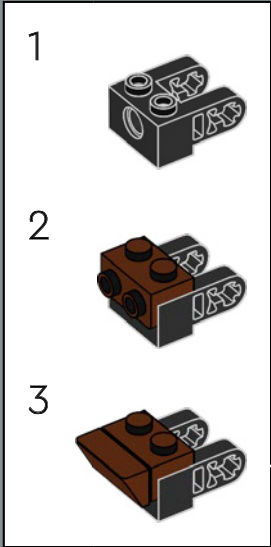

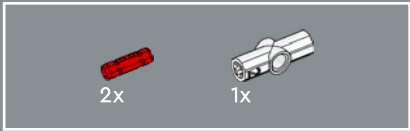
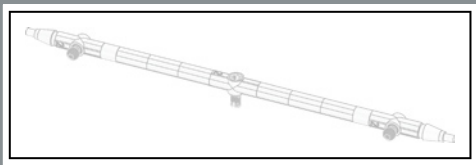

600

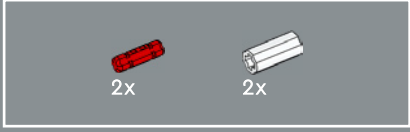
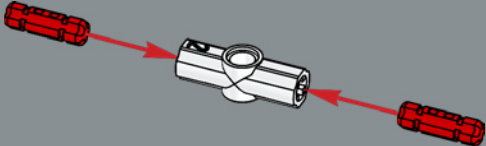

601

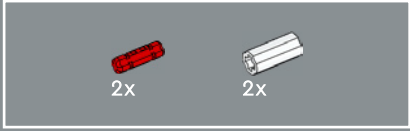
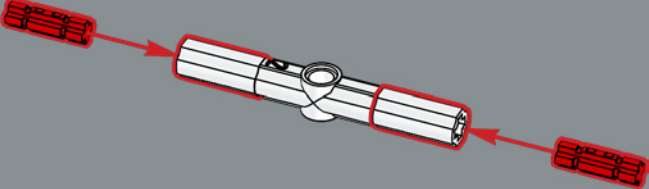

602

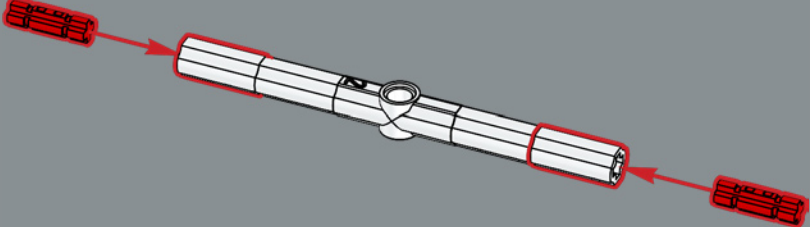

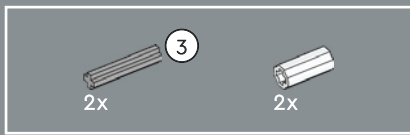

603

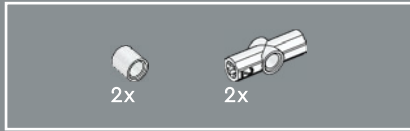
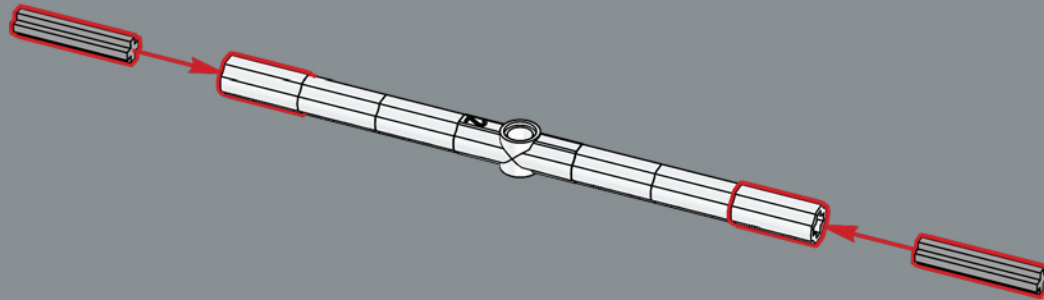

604

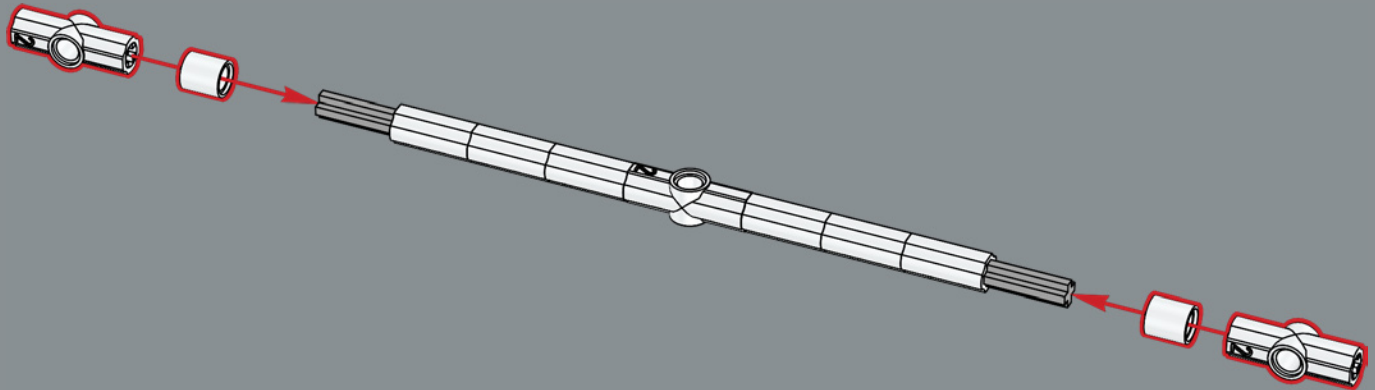

605

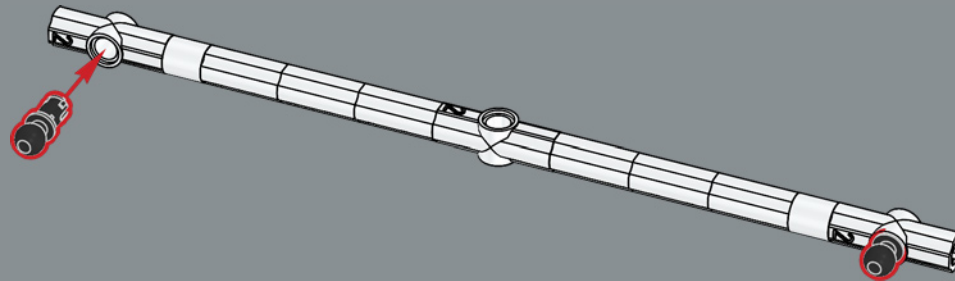



606

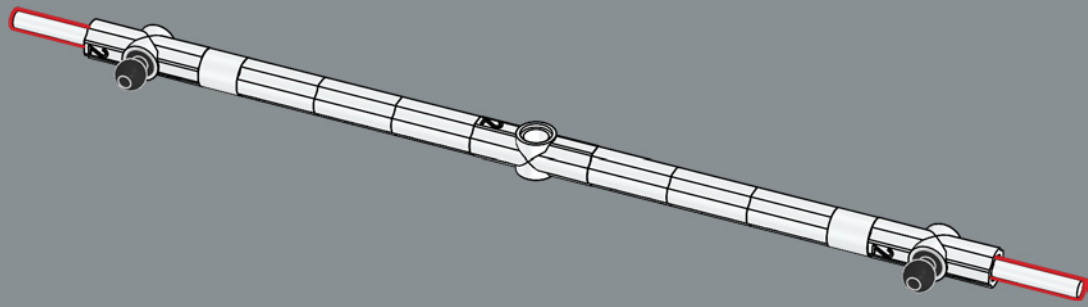

607

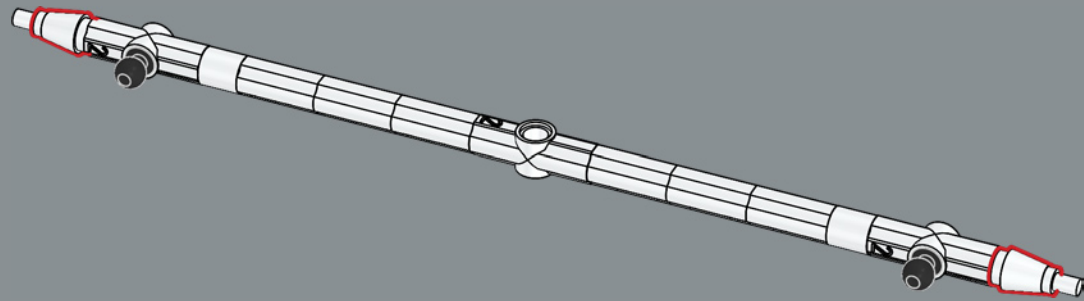

608

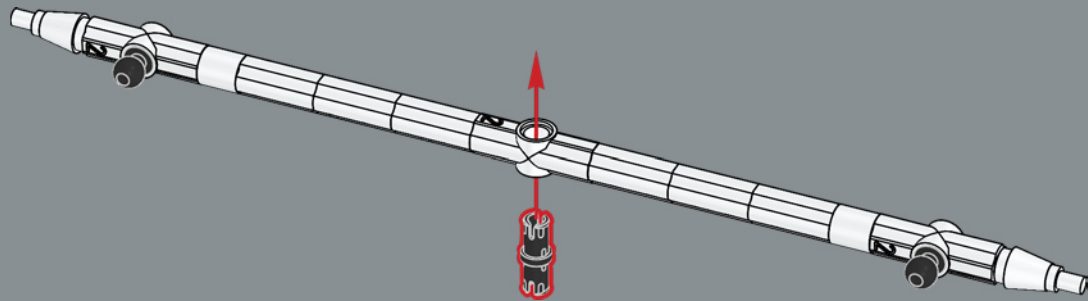

609



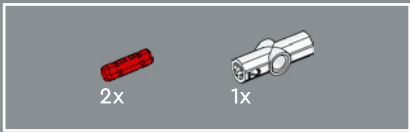
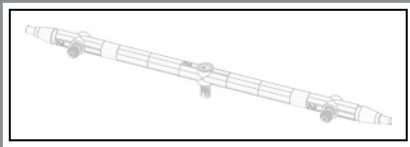

610

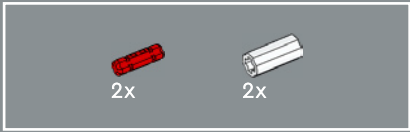
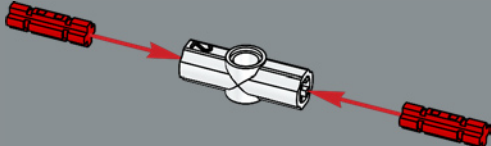

611

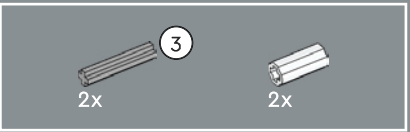
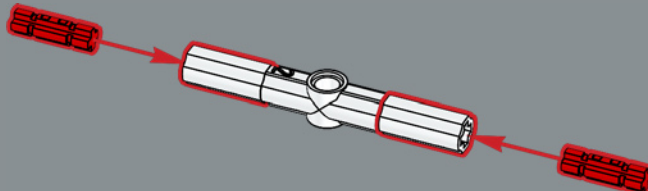

612

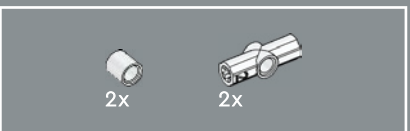
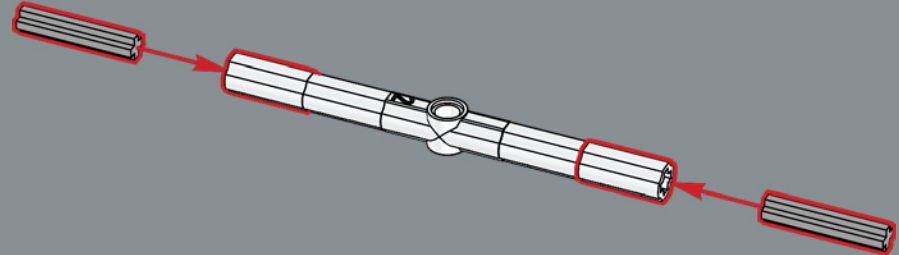

613

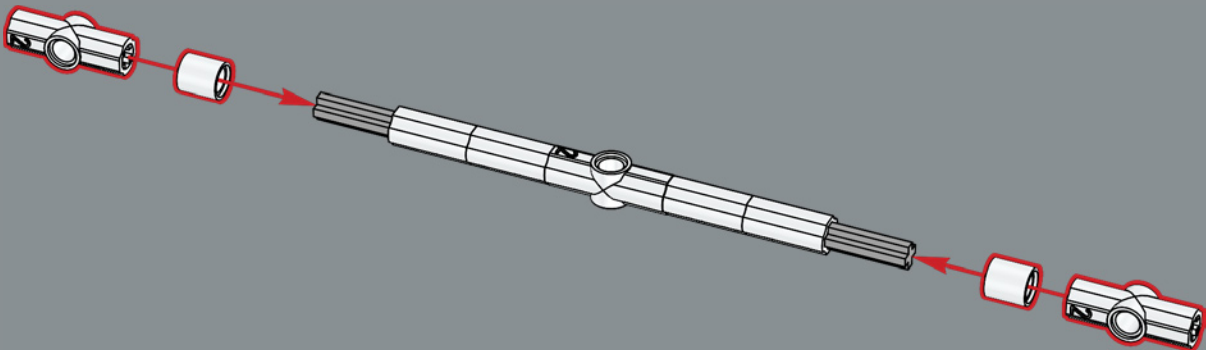



614

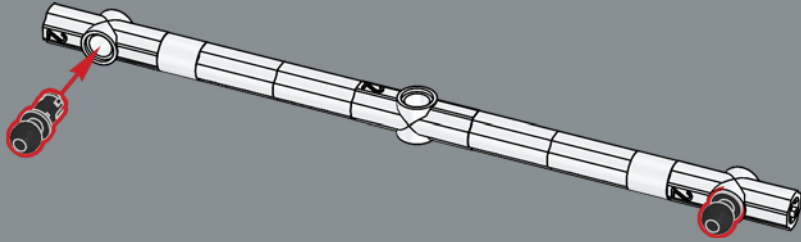

615

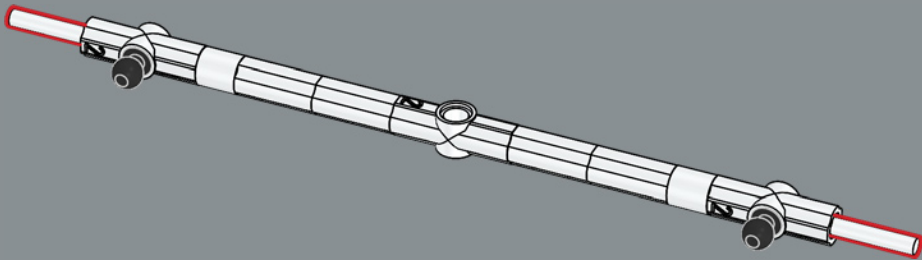

616

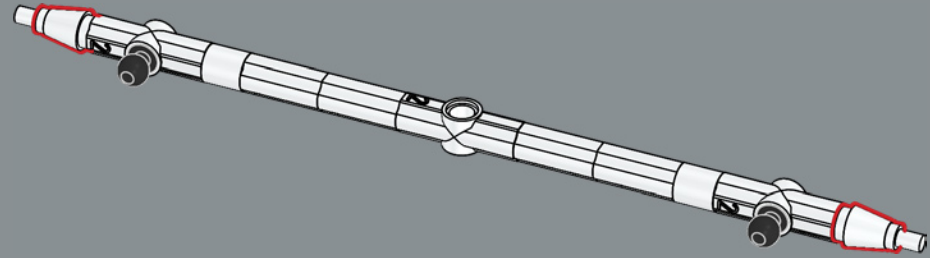

617

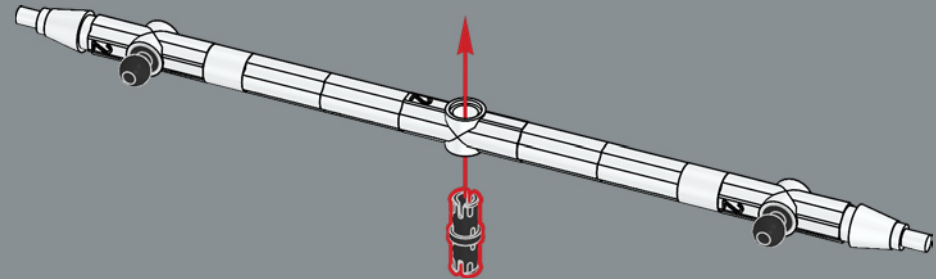

618



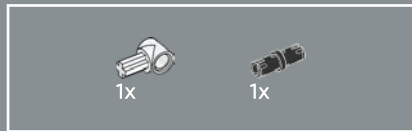
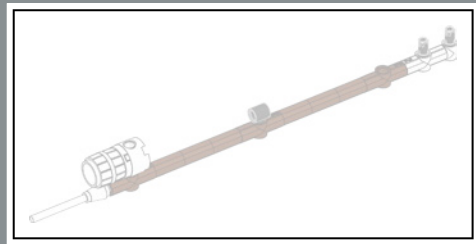

619

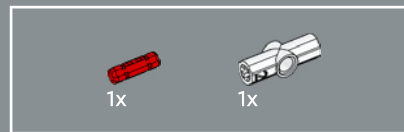
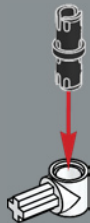

620

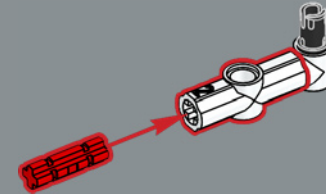

621

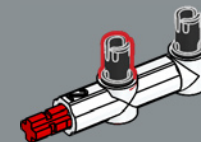

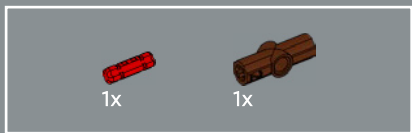

622

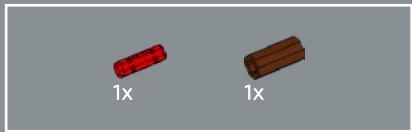
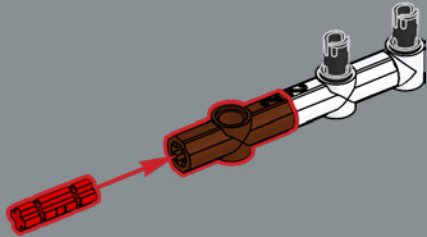

623

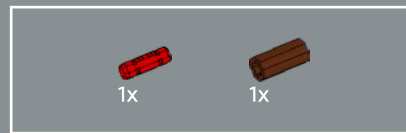
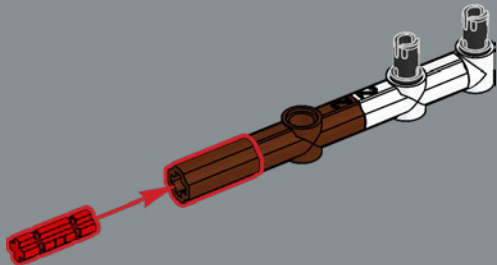

624

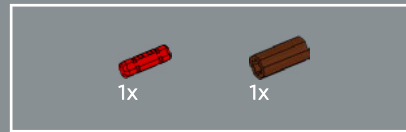
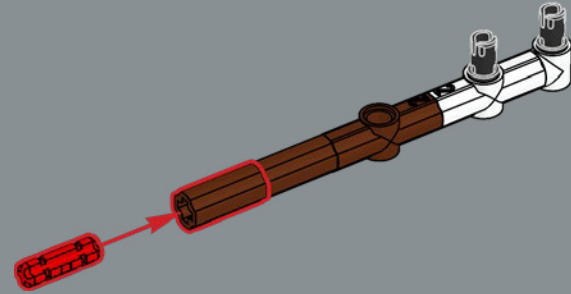

625

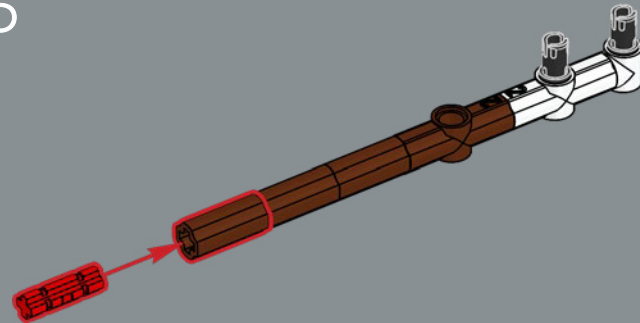

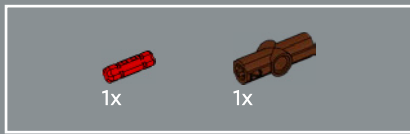

626

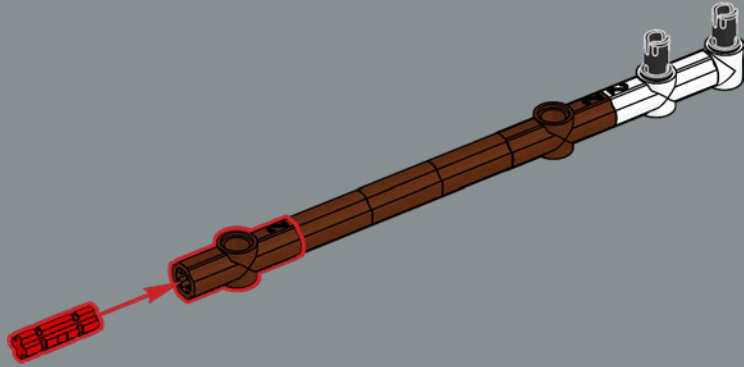

627

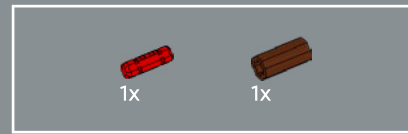
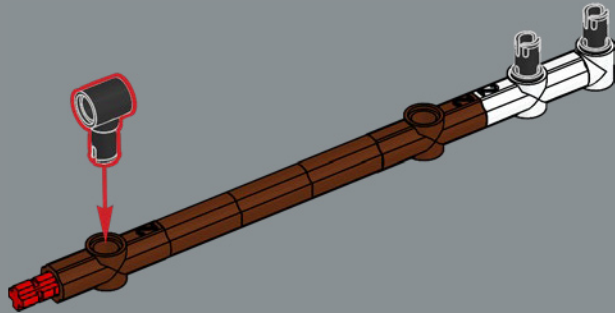

628

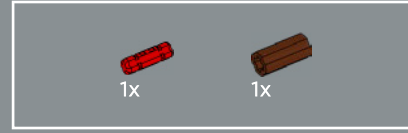
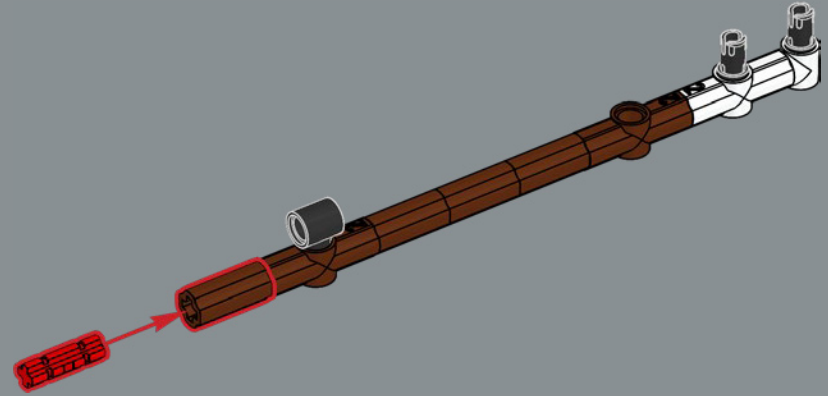

629

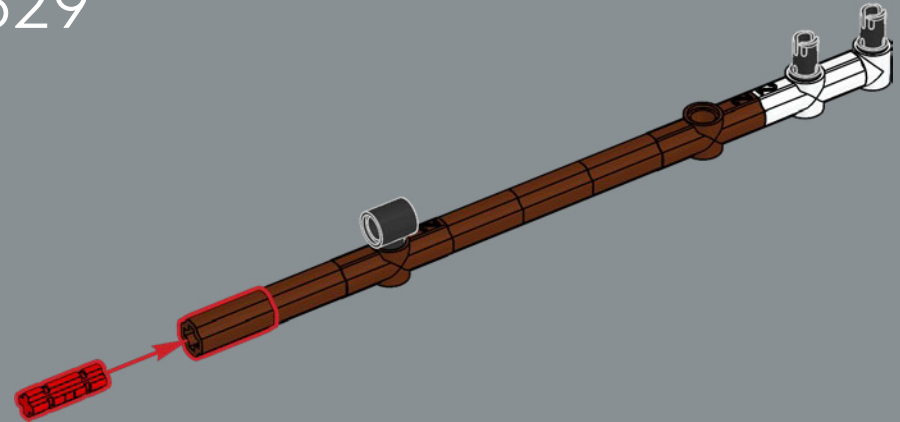

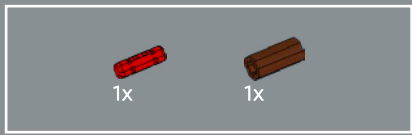

630

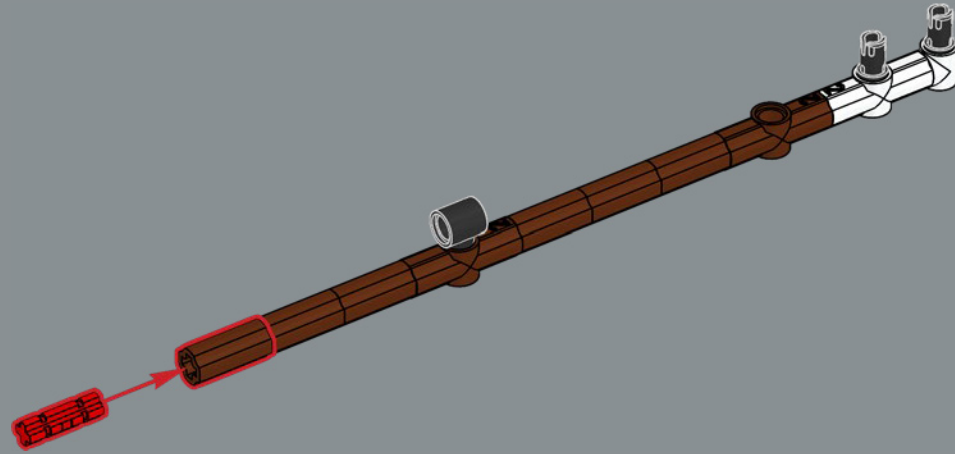

631

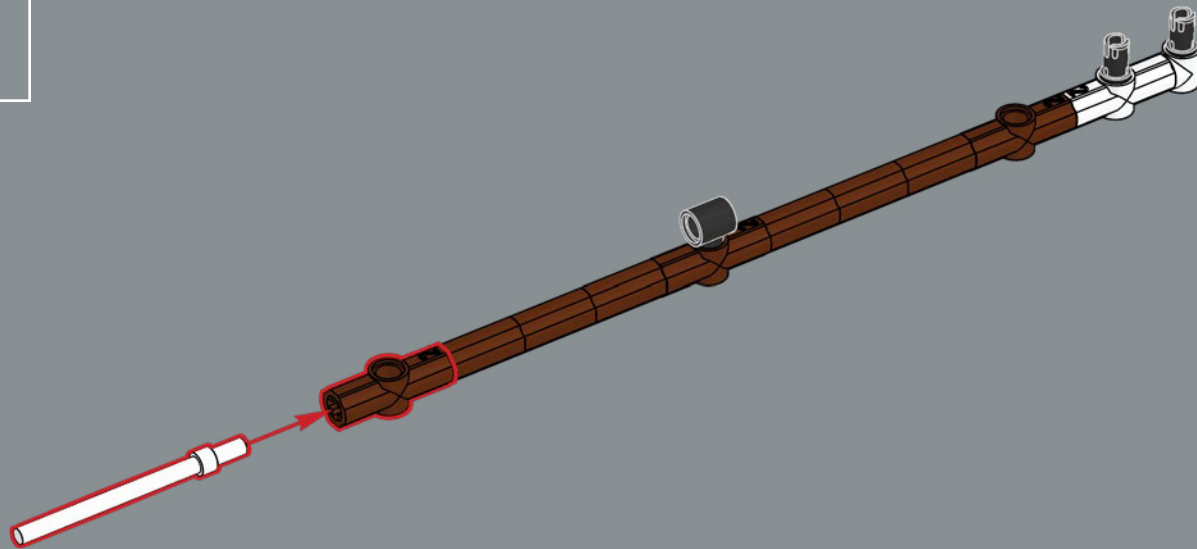



632

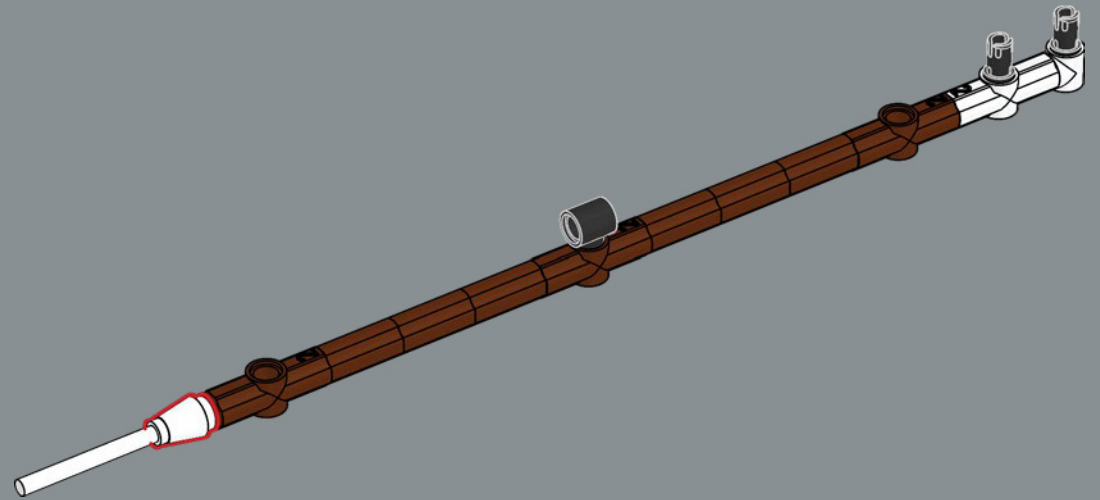

633

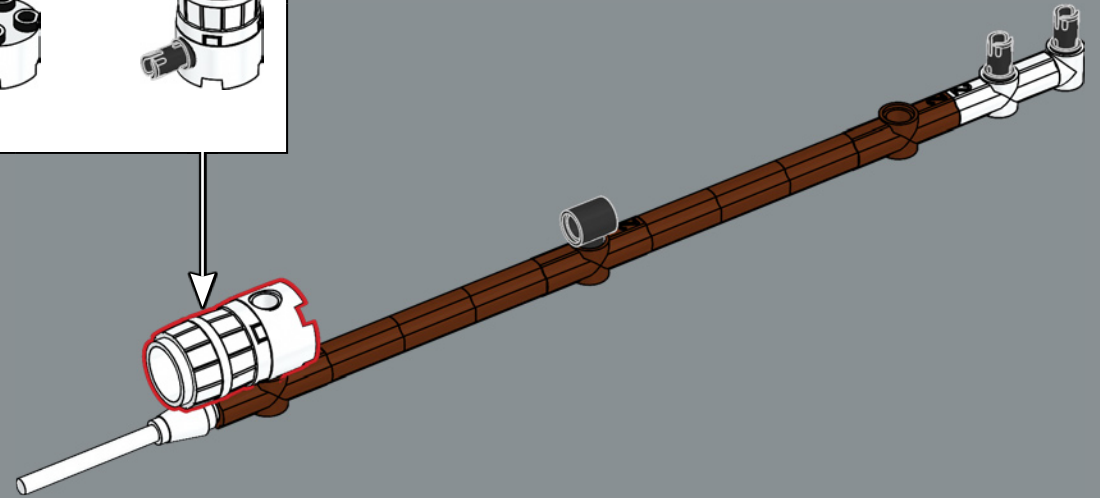
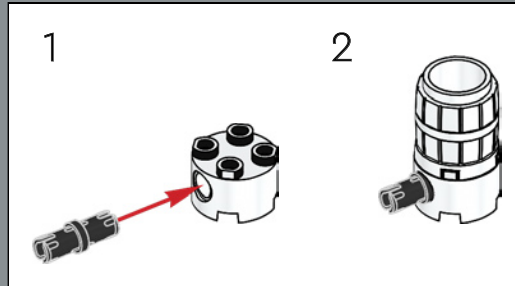

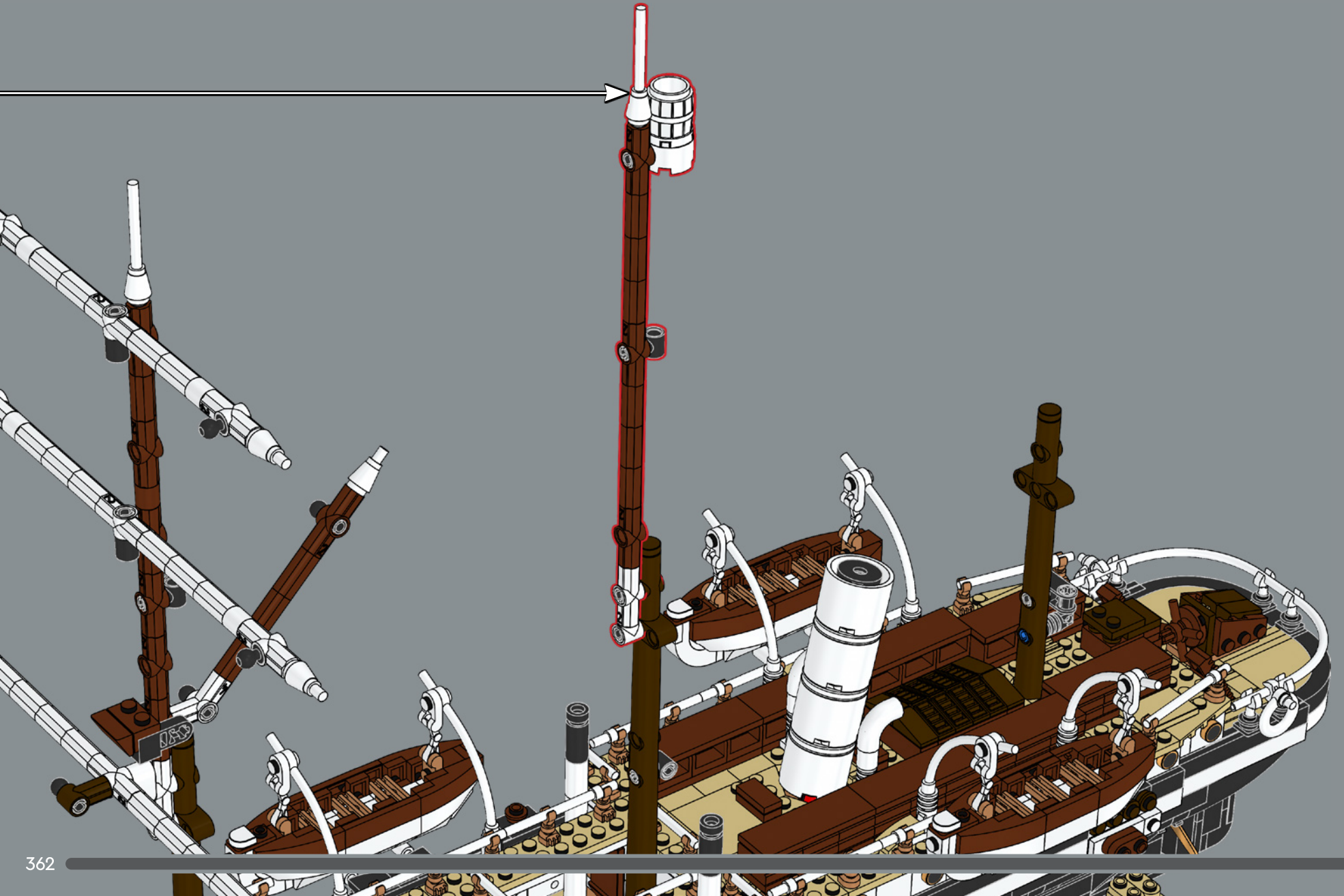

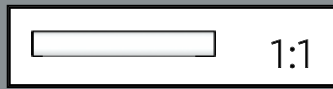
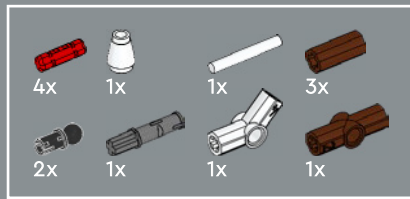

635

1

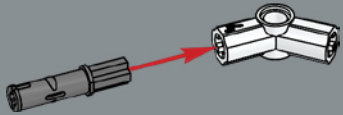

2

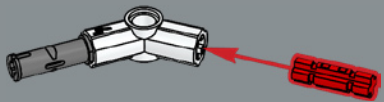

3

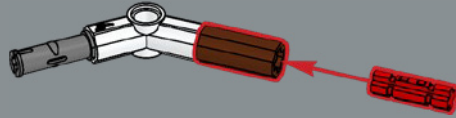

4



5

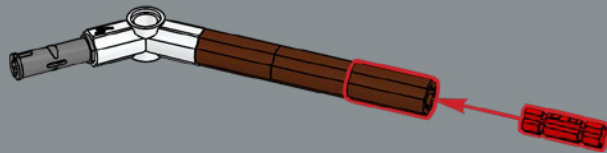

6

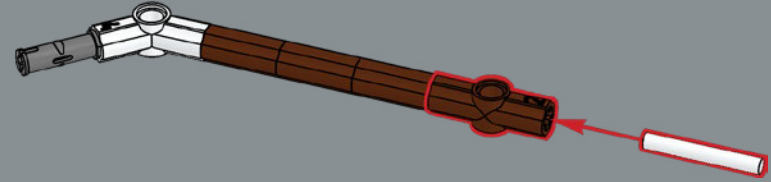

7

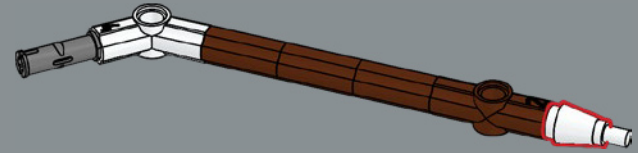

8

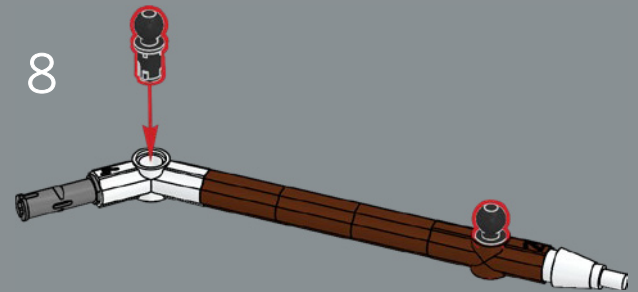





636

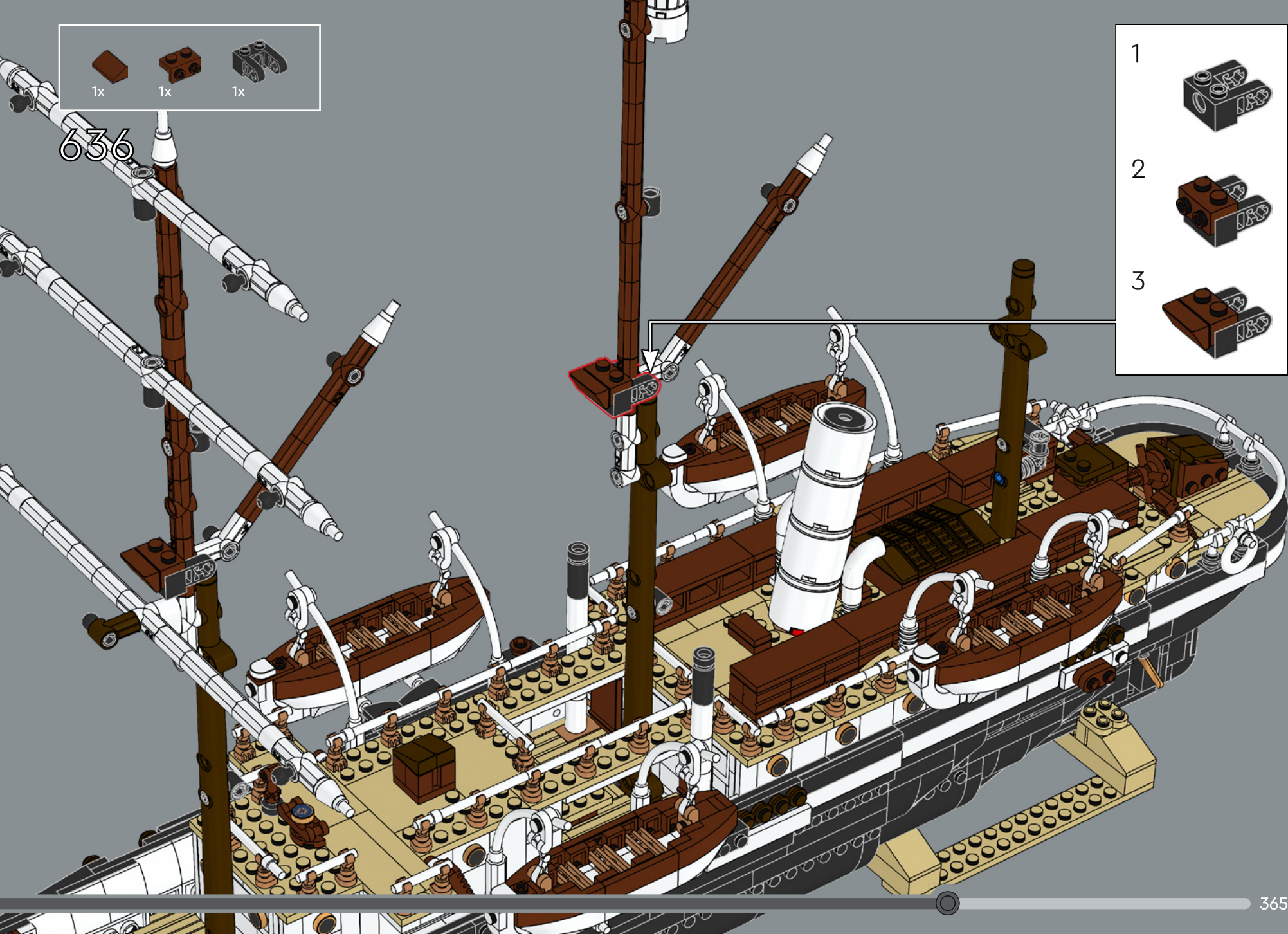
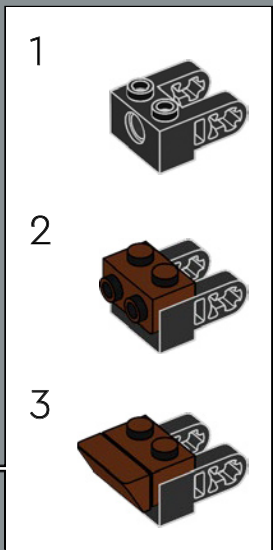

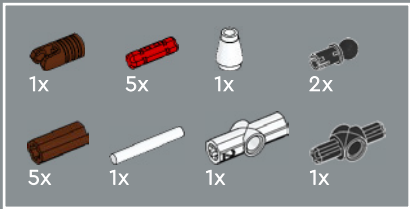

637

1

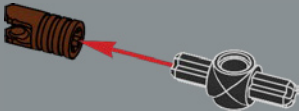

2

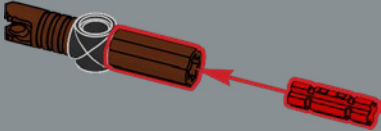

3

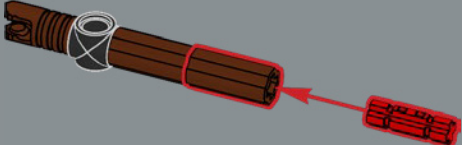

4

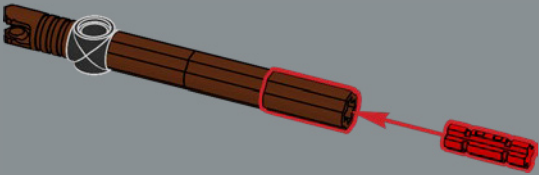

5

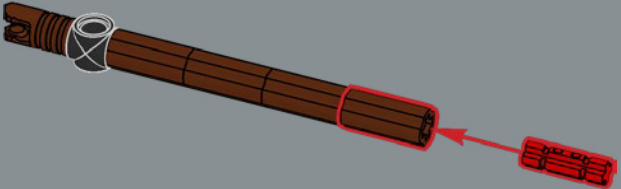

6

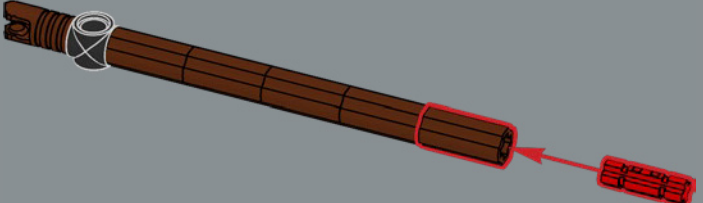

7

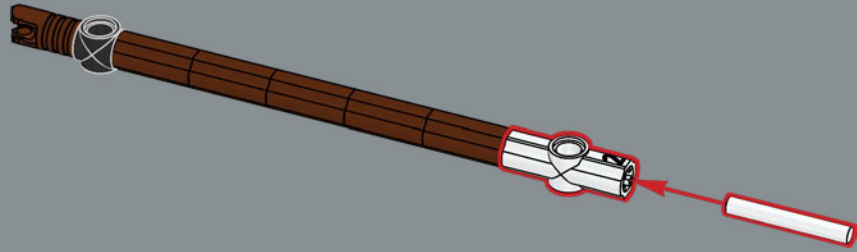

8

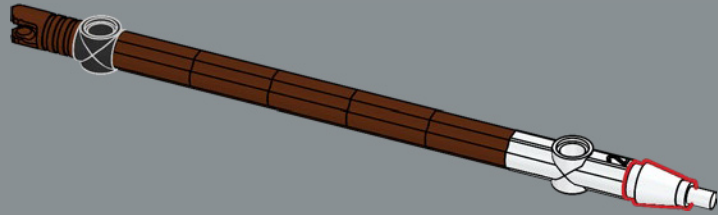

9

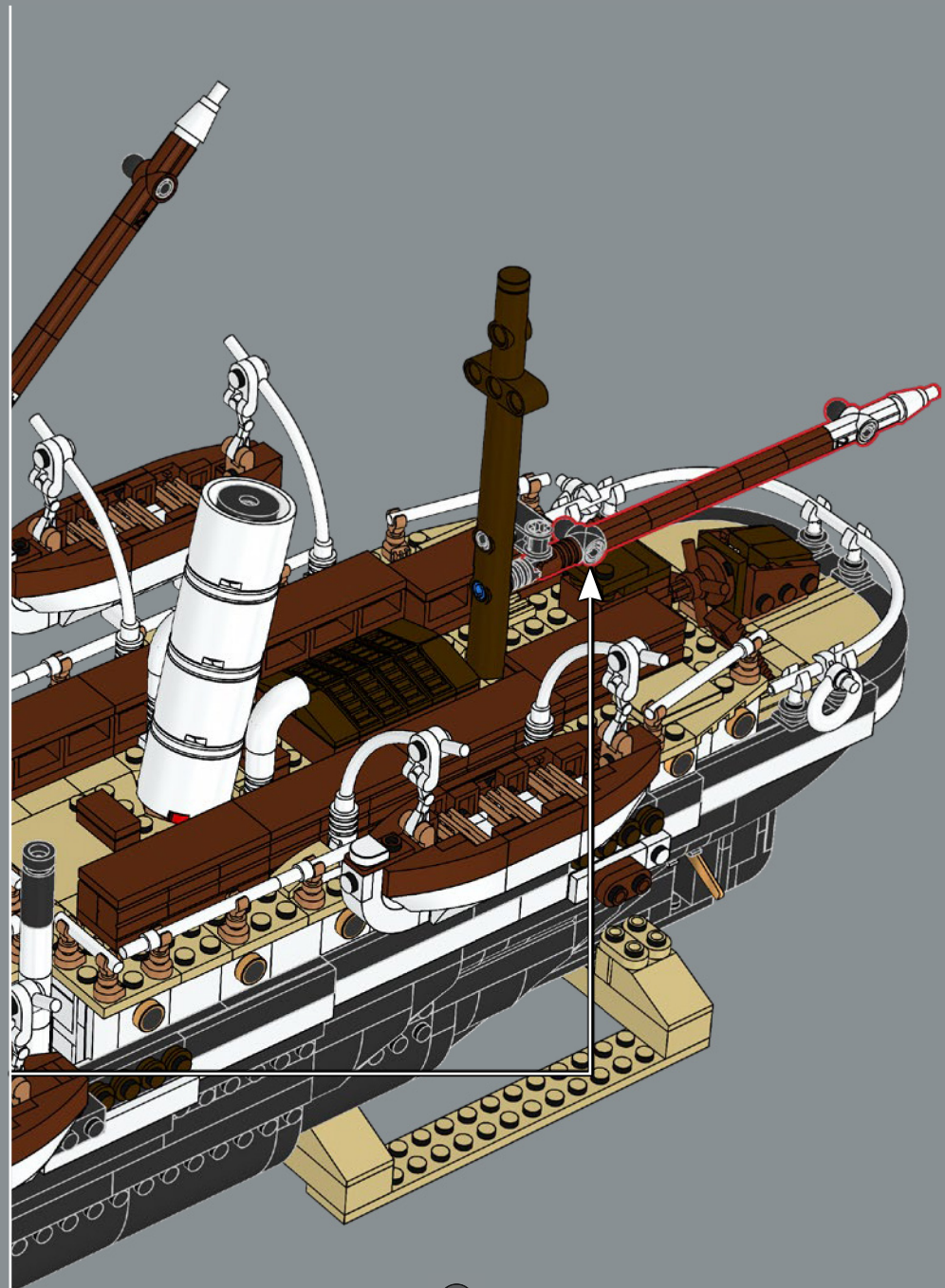
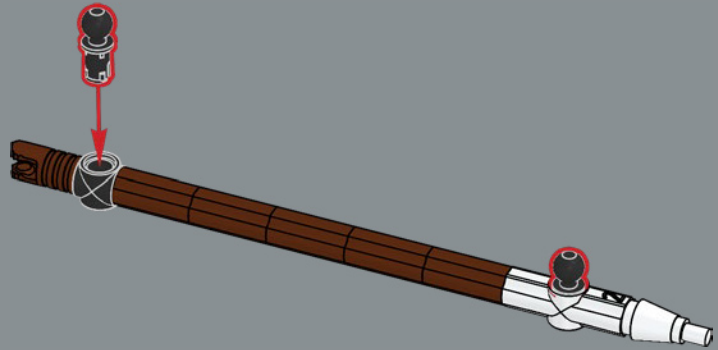

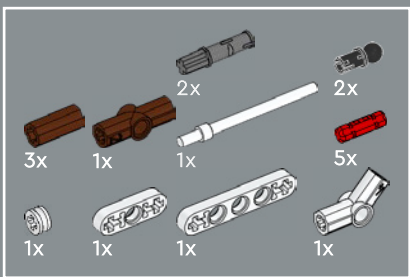

638

1

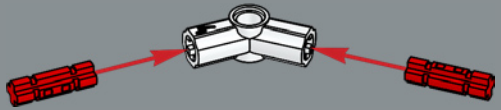

2

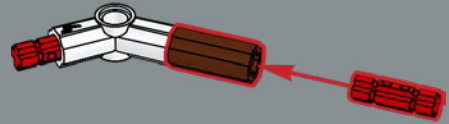

3

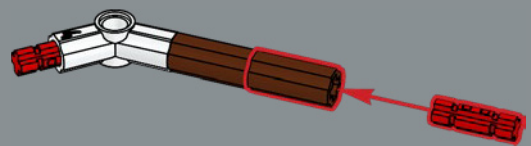

4

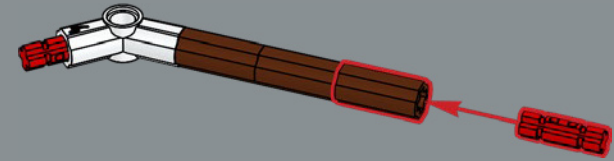

5

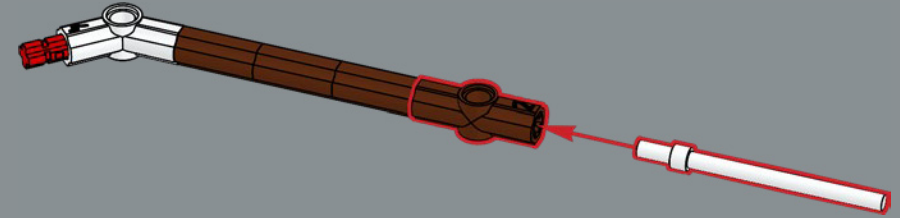

6

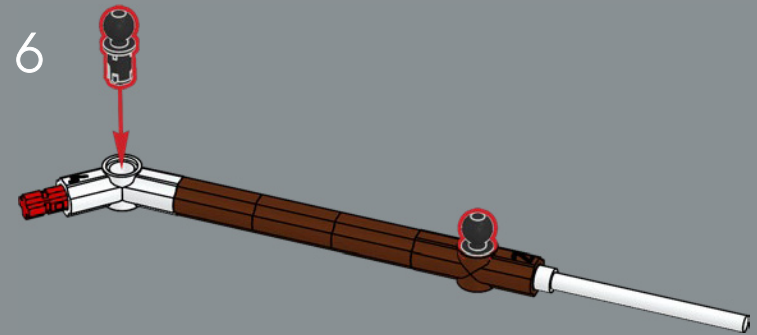

7

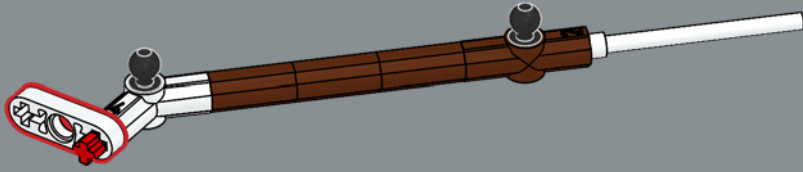

9

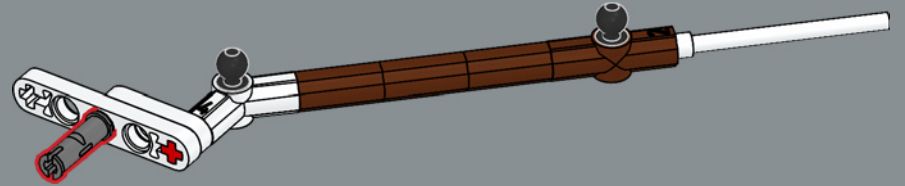

8

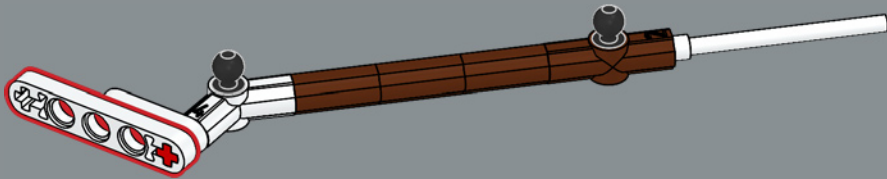

10

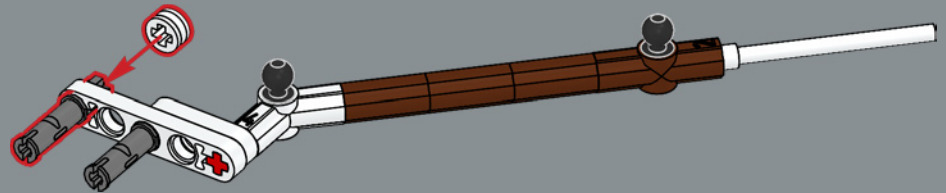

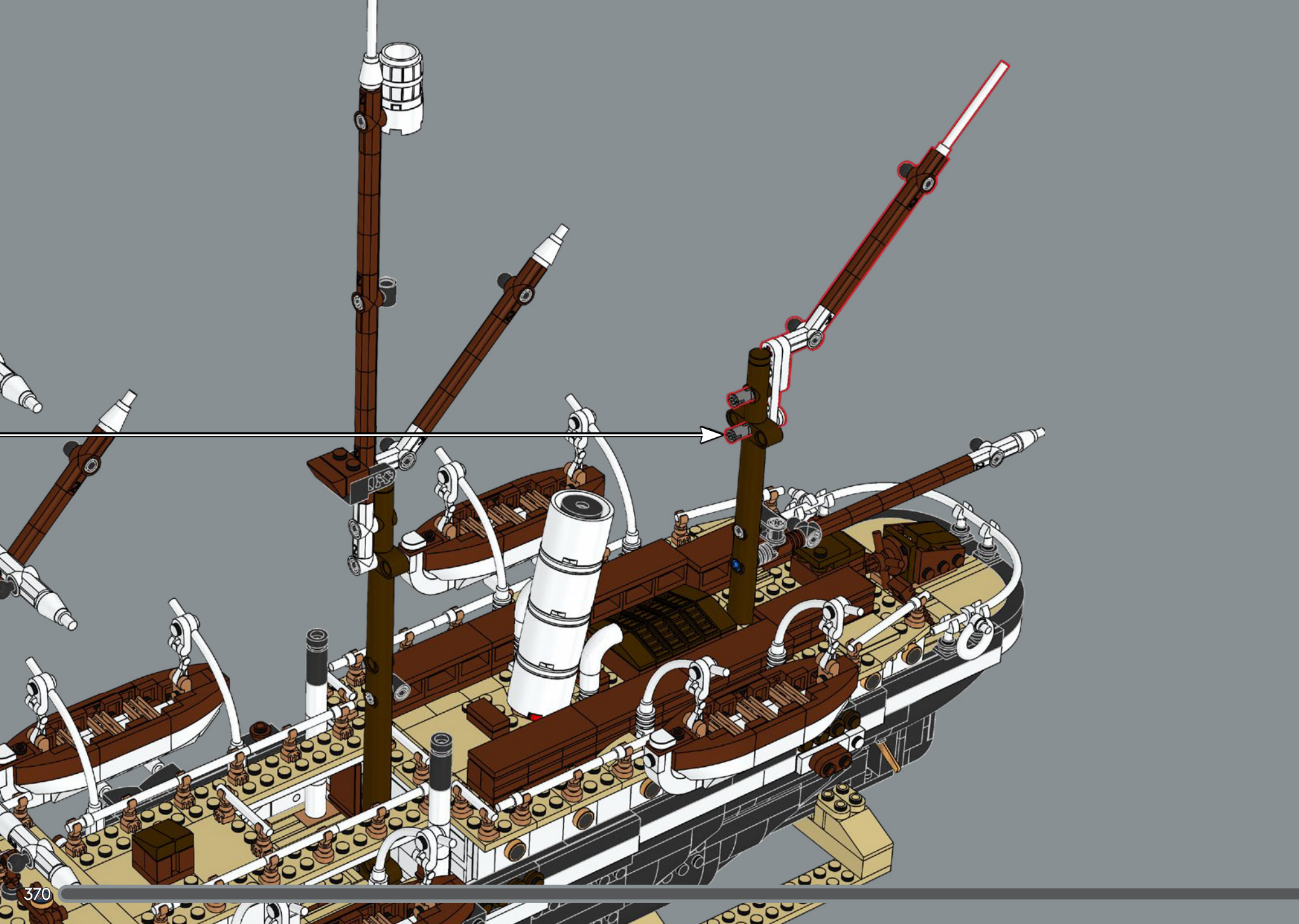

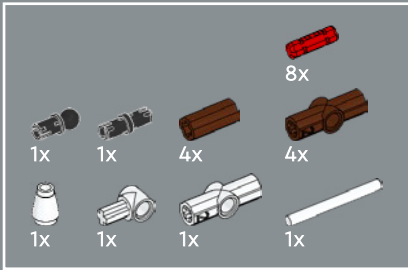
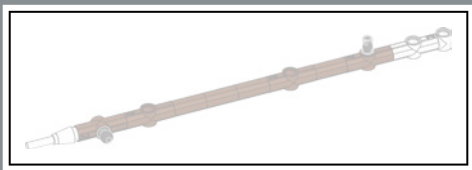

639

1

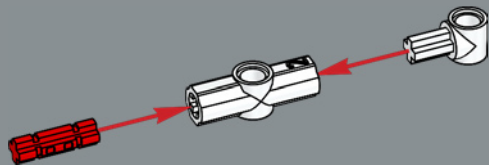

2

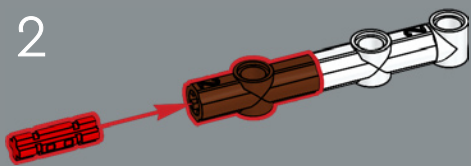

3

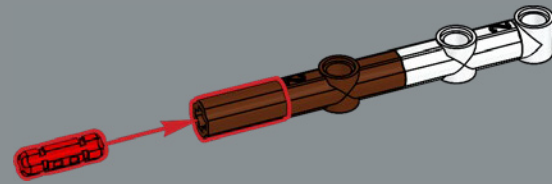

4

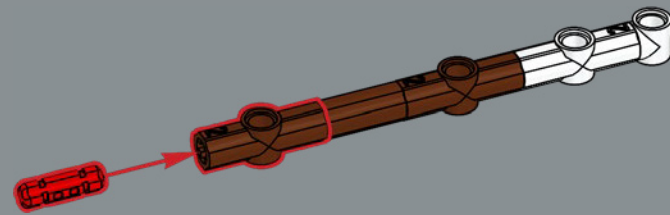

5

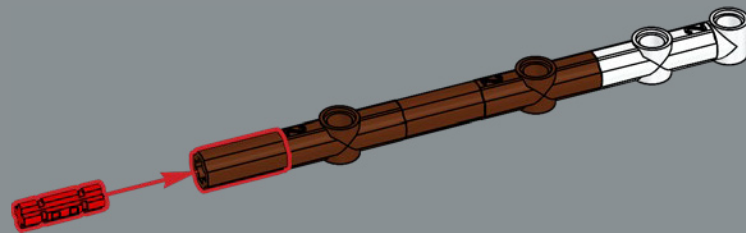

6

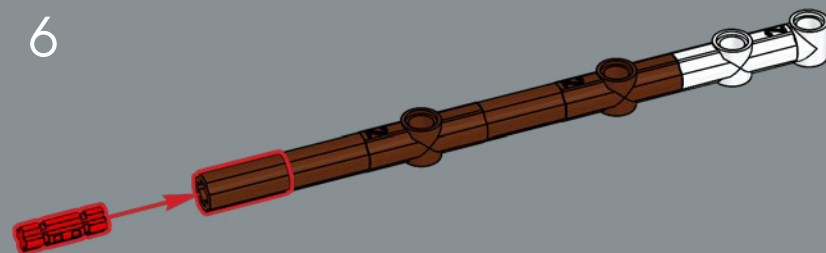

7

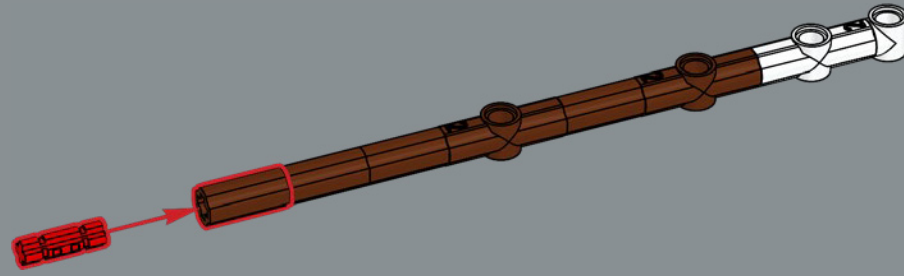

8



9

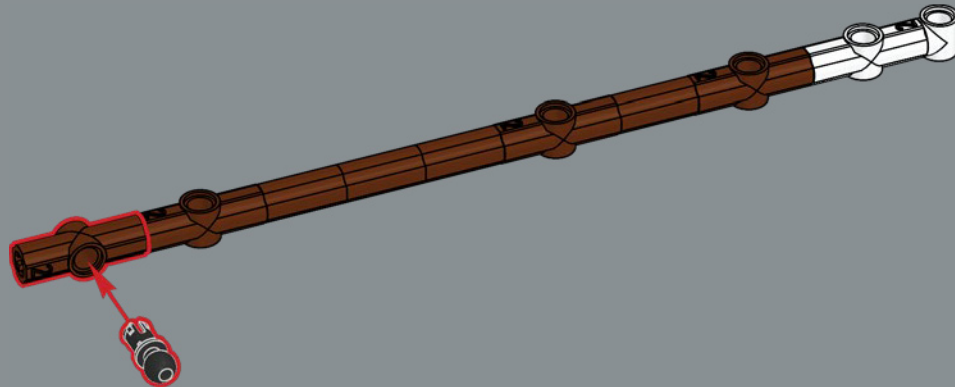

10

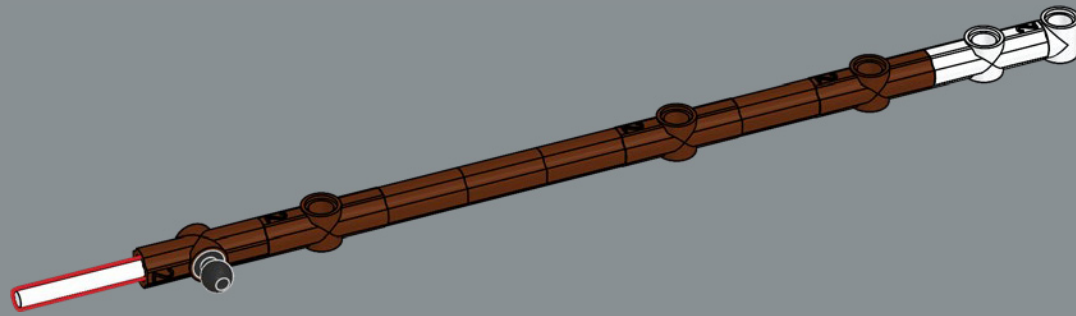

11

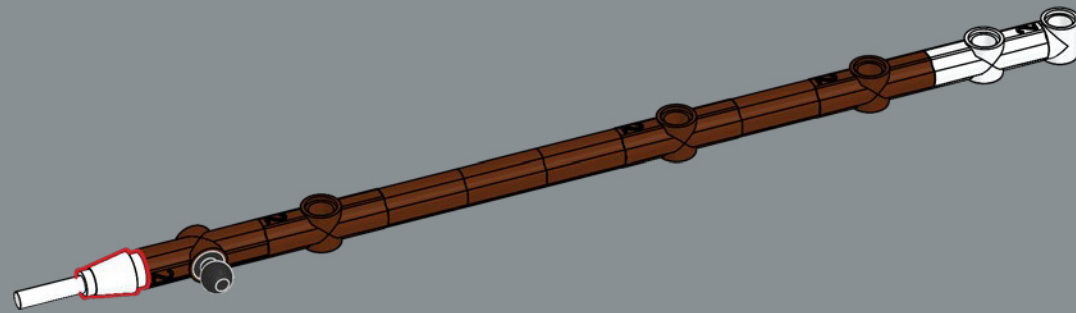

12

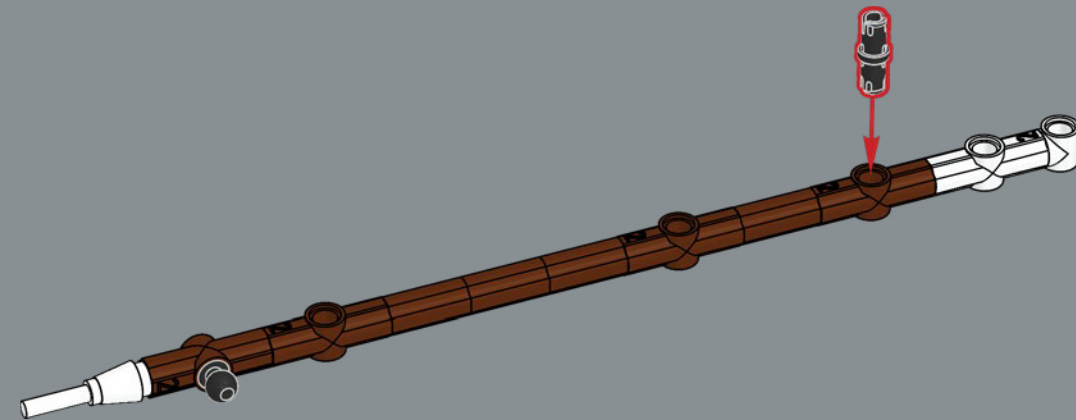

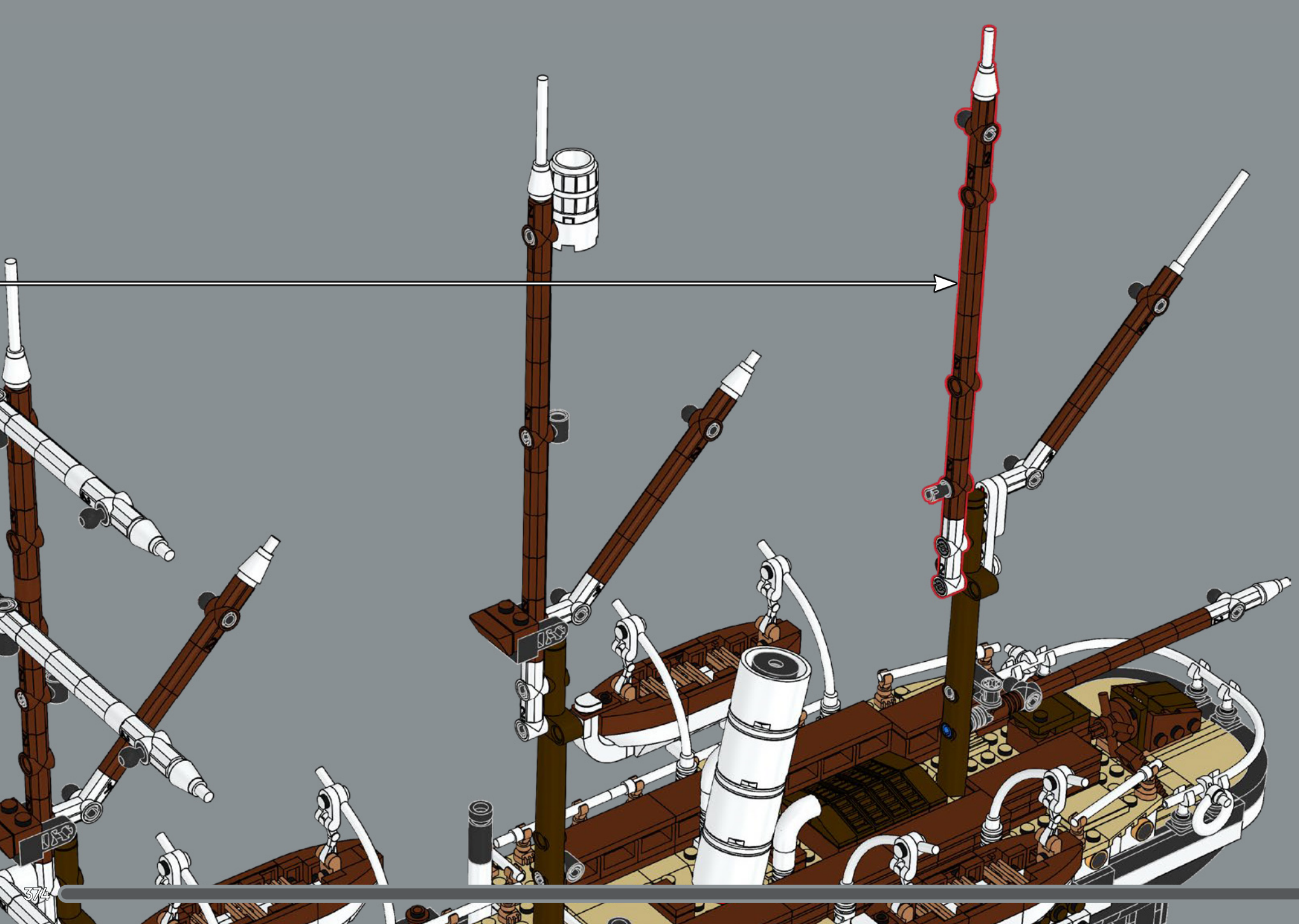



640

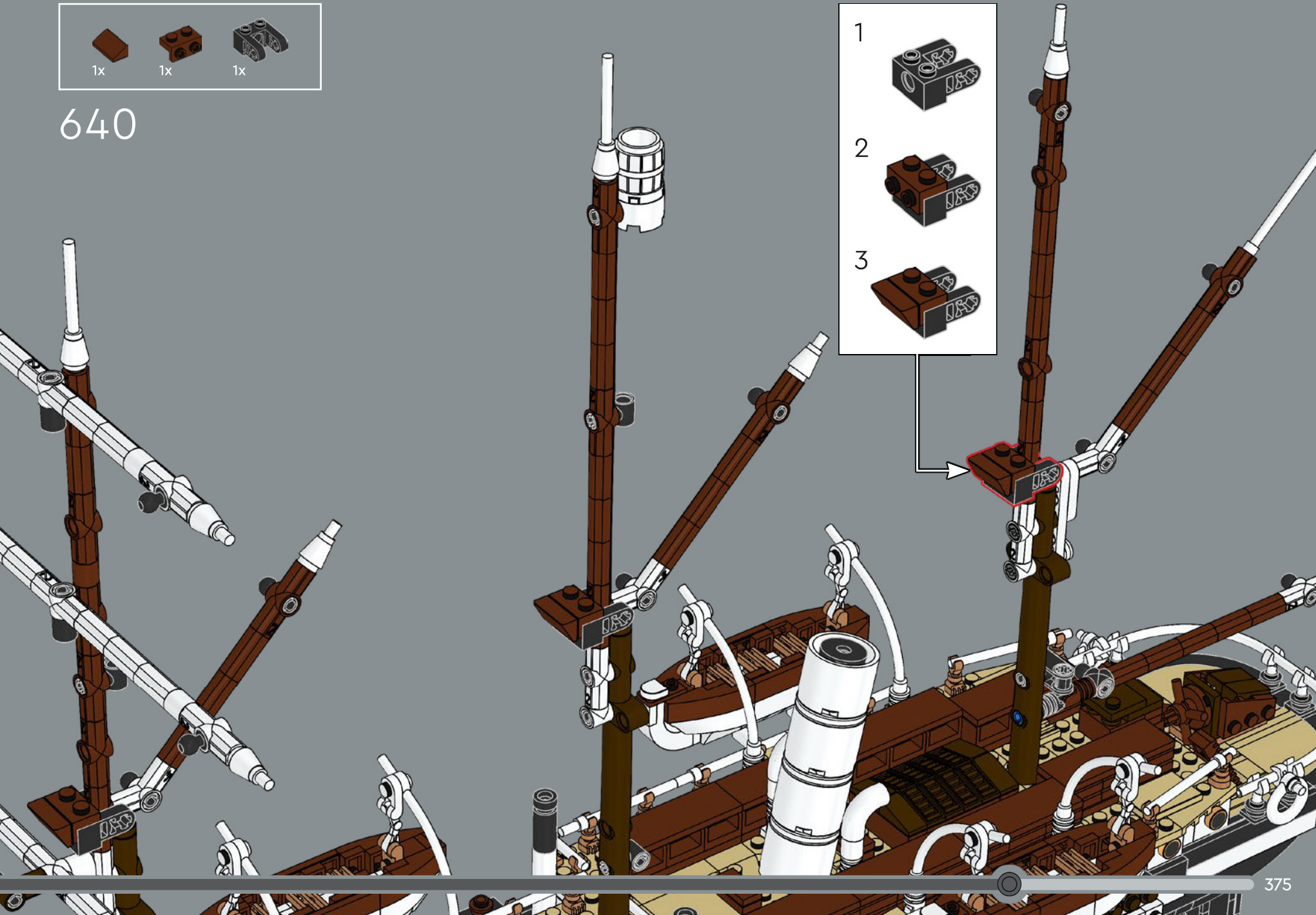
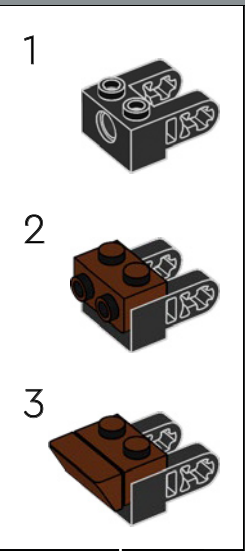

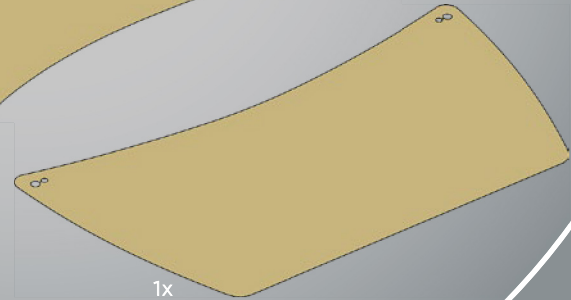
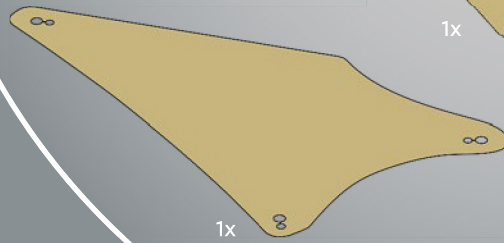
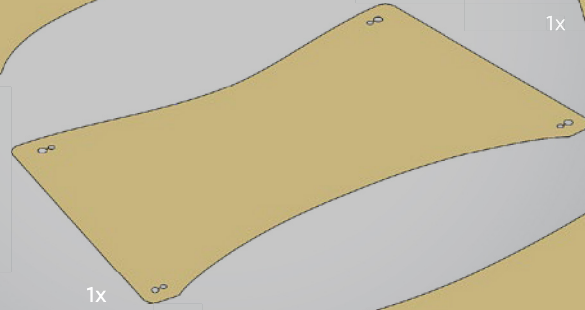
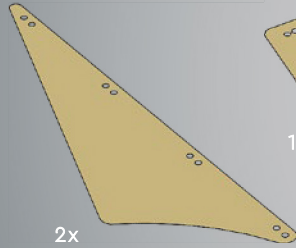
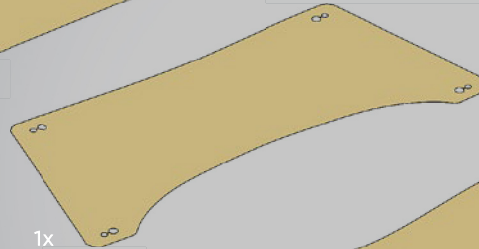
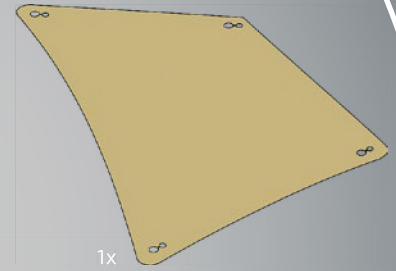
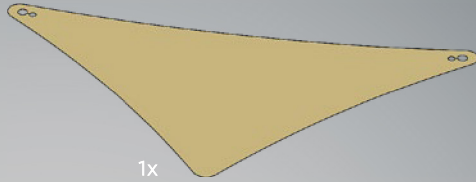
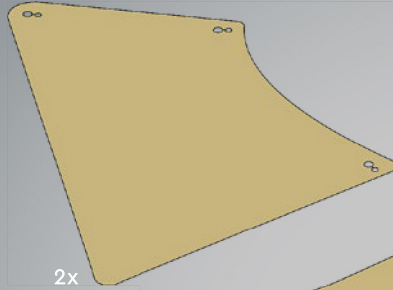
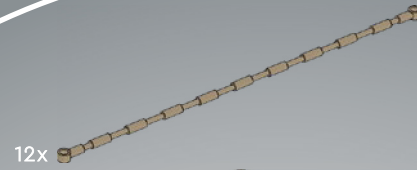
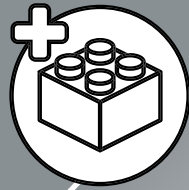



641

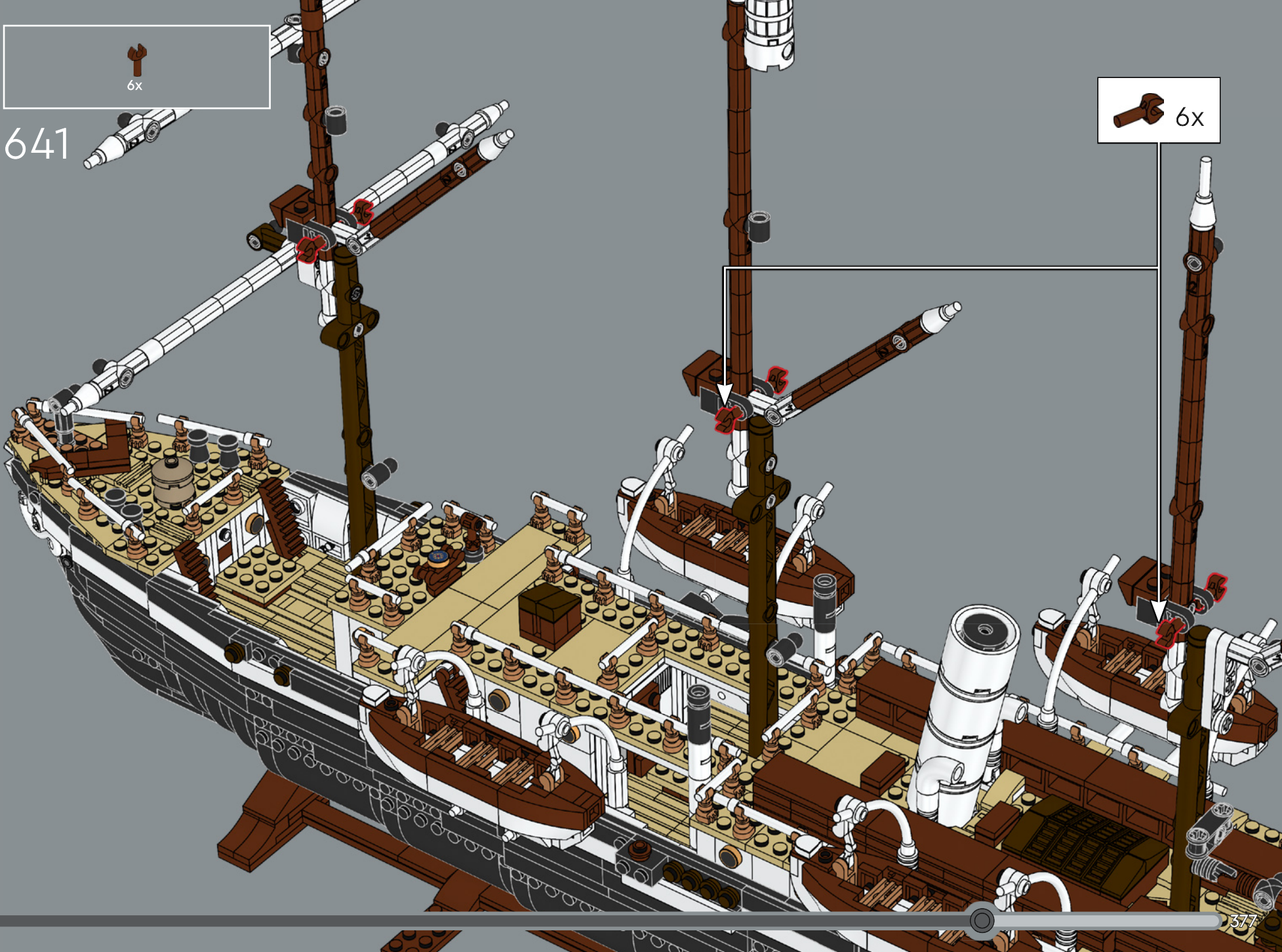

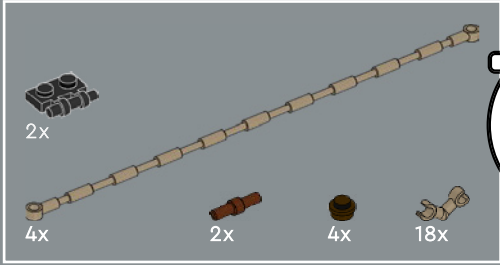
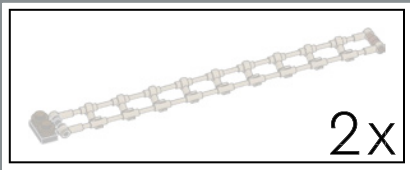

642

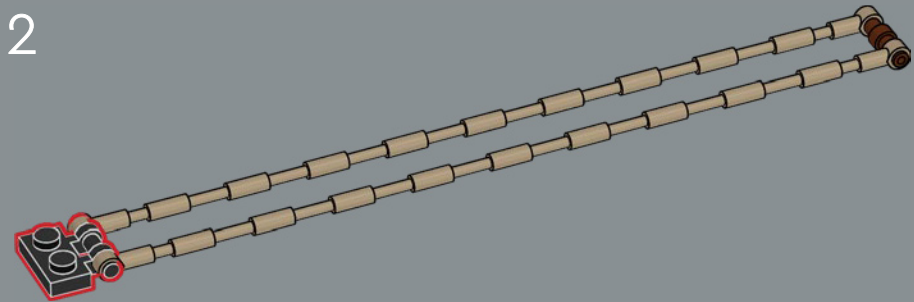
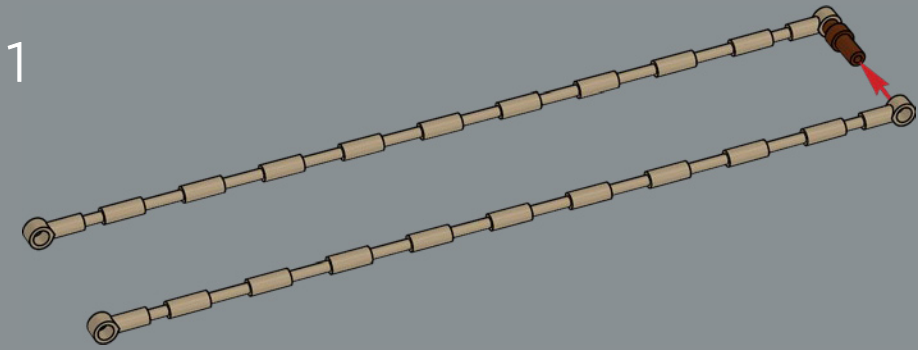

3

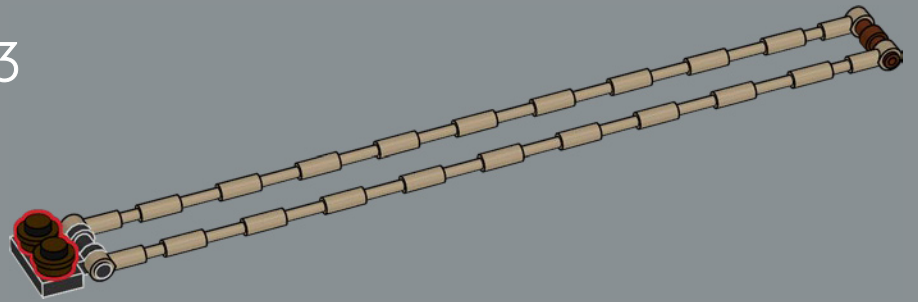

4

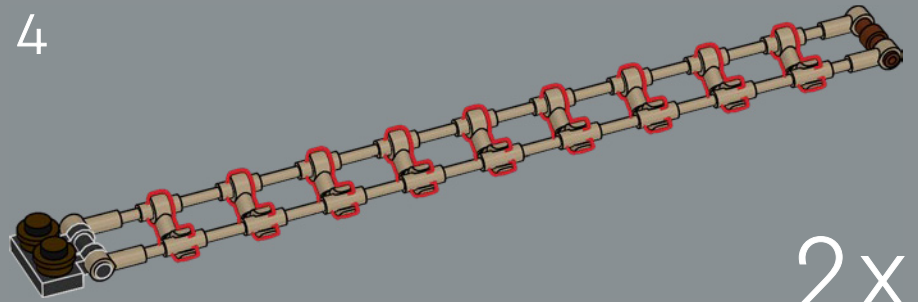



Le scale di corda sono state realizzate in marrone scuro per distinguere il materiale dalla maggior parte della struttura in legno della nave.



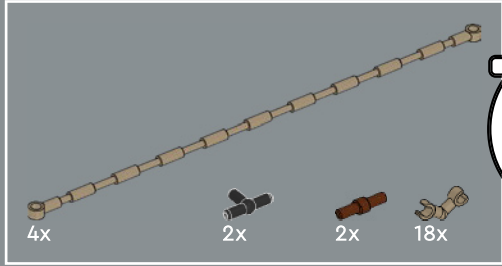
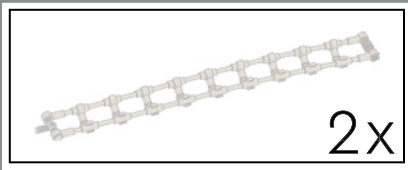

643

1

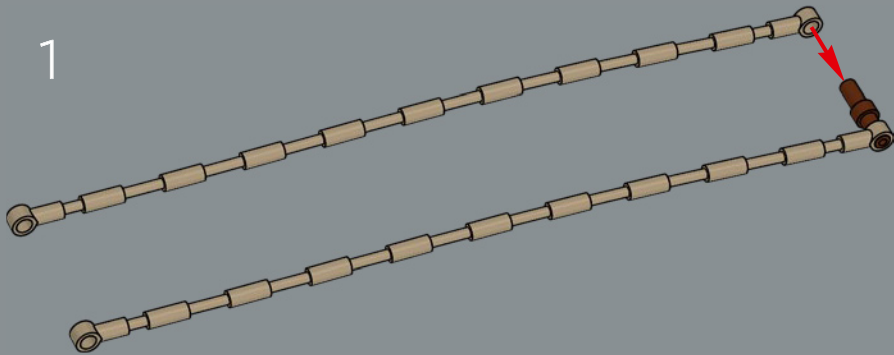

2

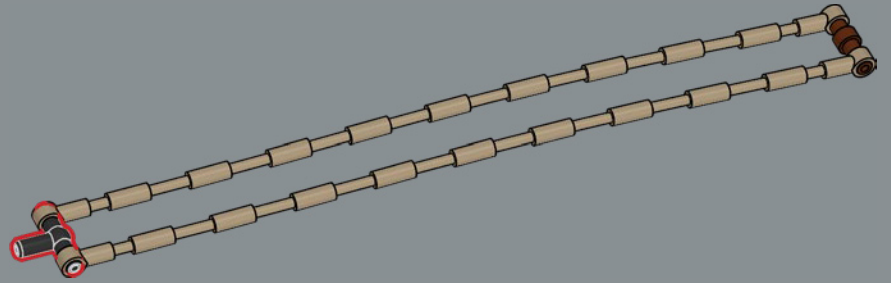

3

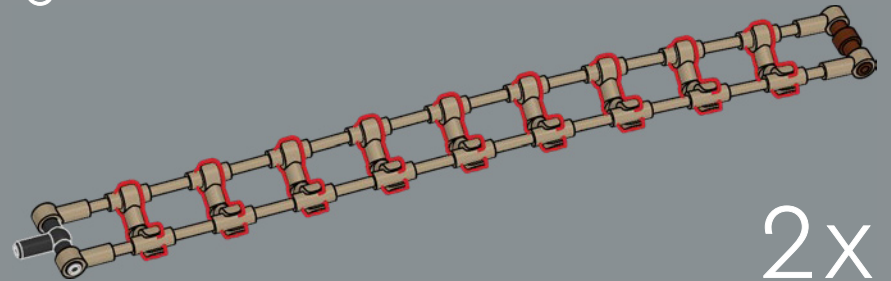

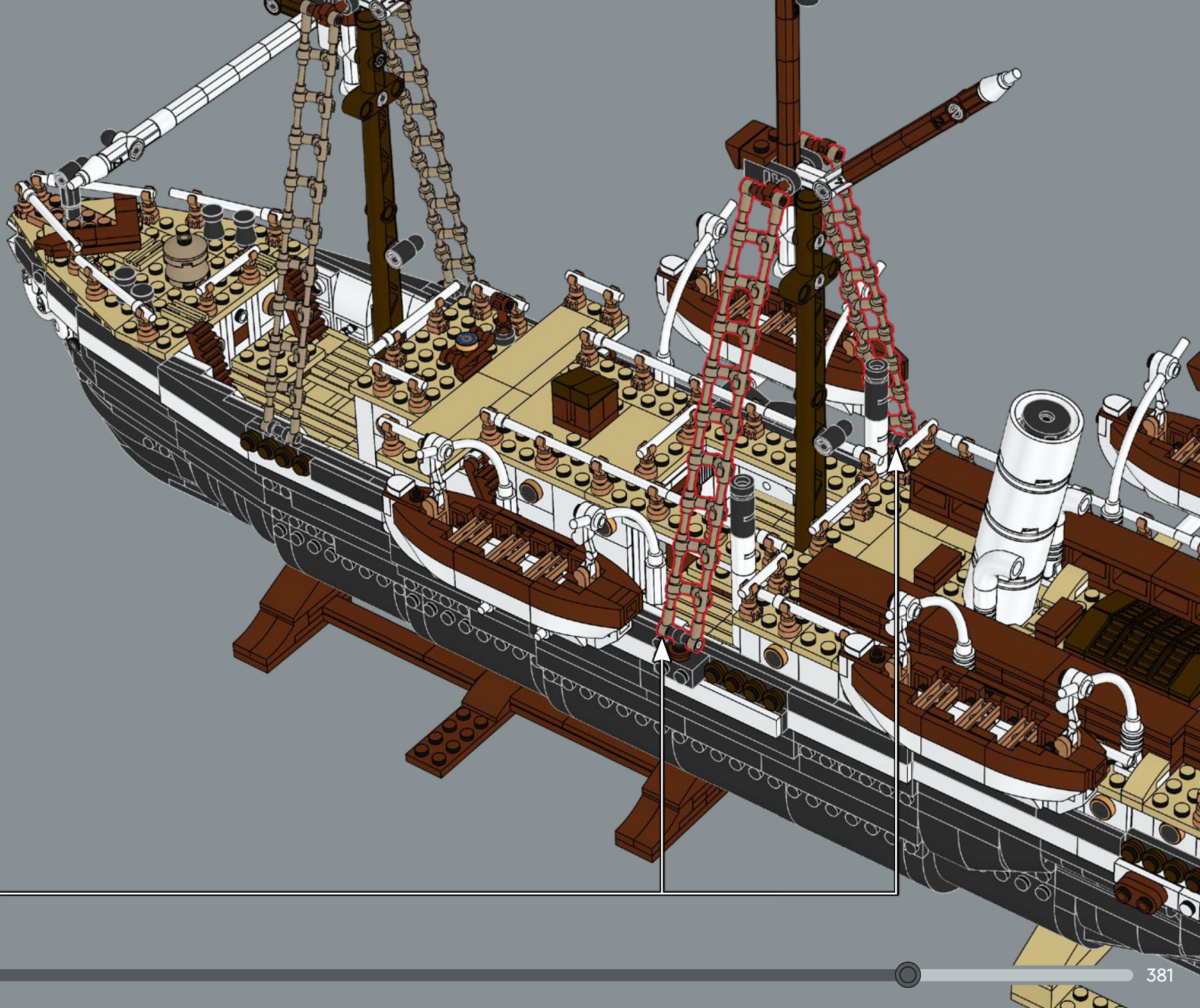

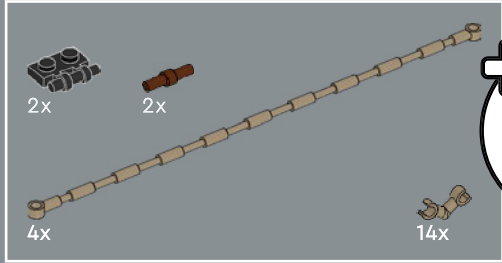
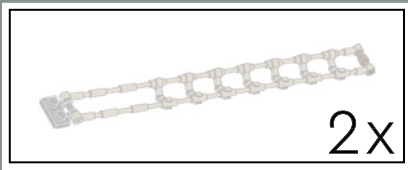

644

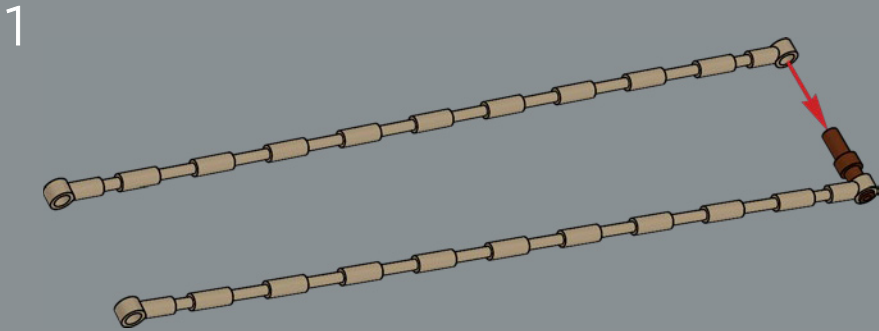

2

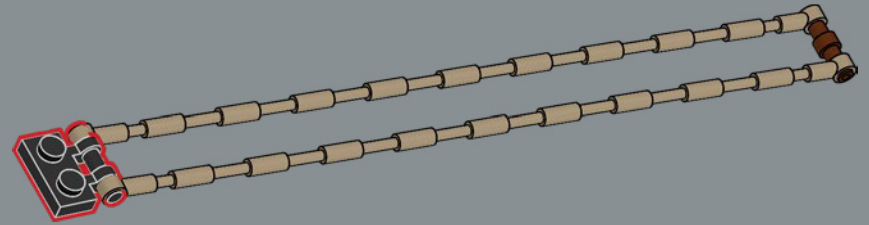

3

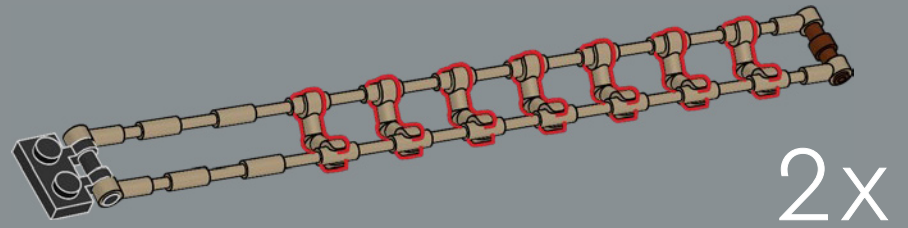

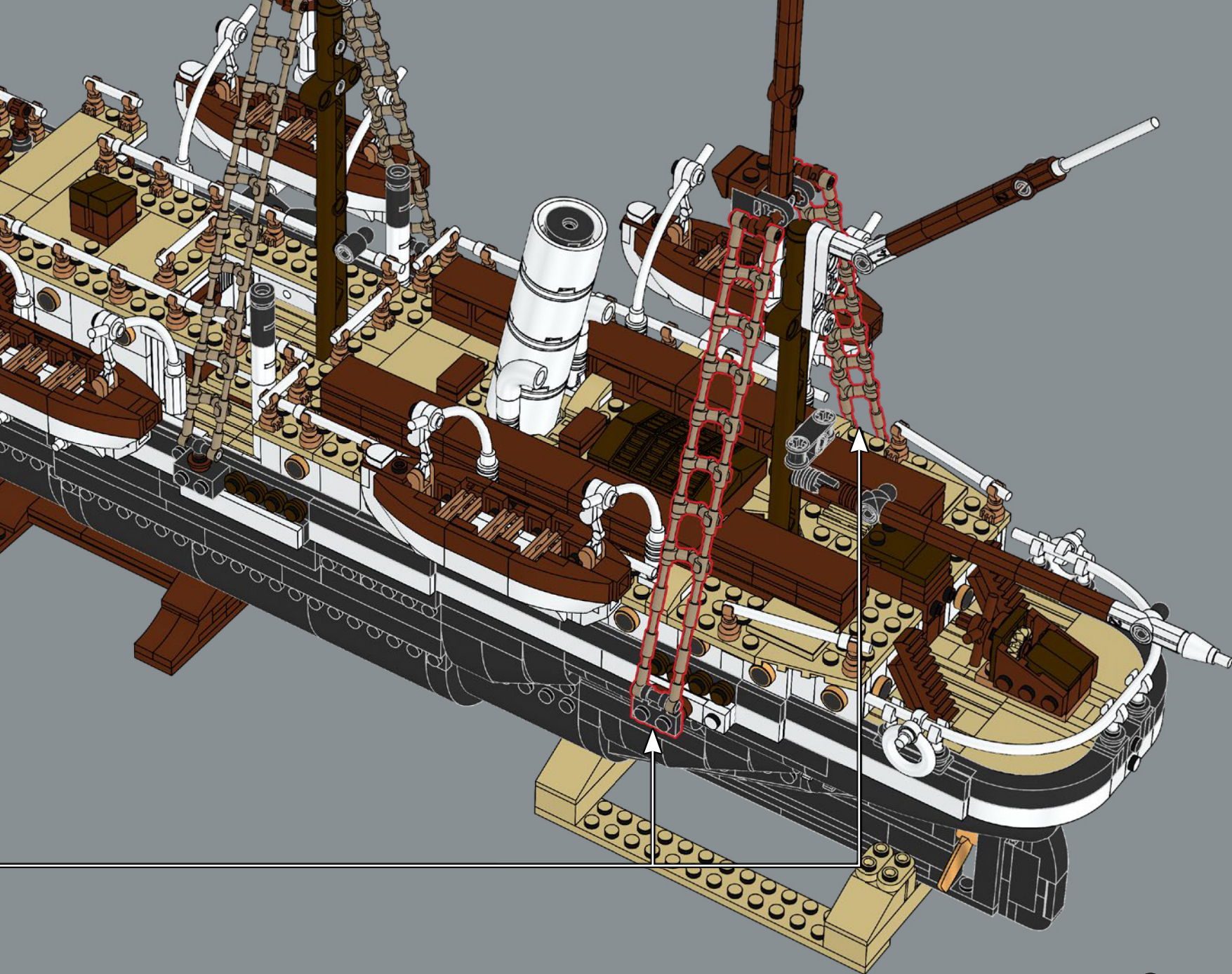

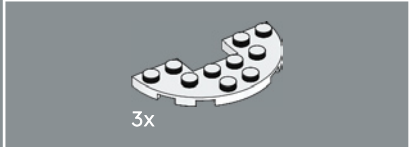

645



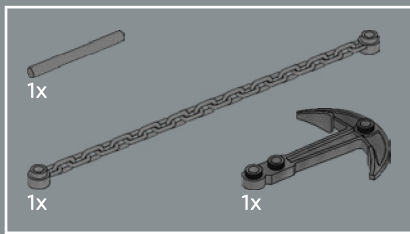

646

1

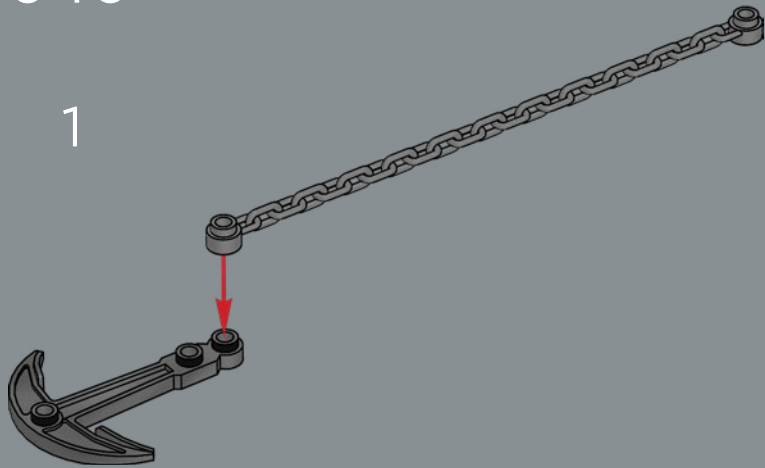

2

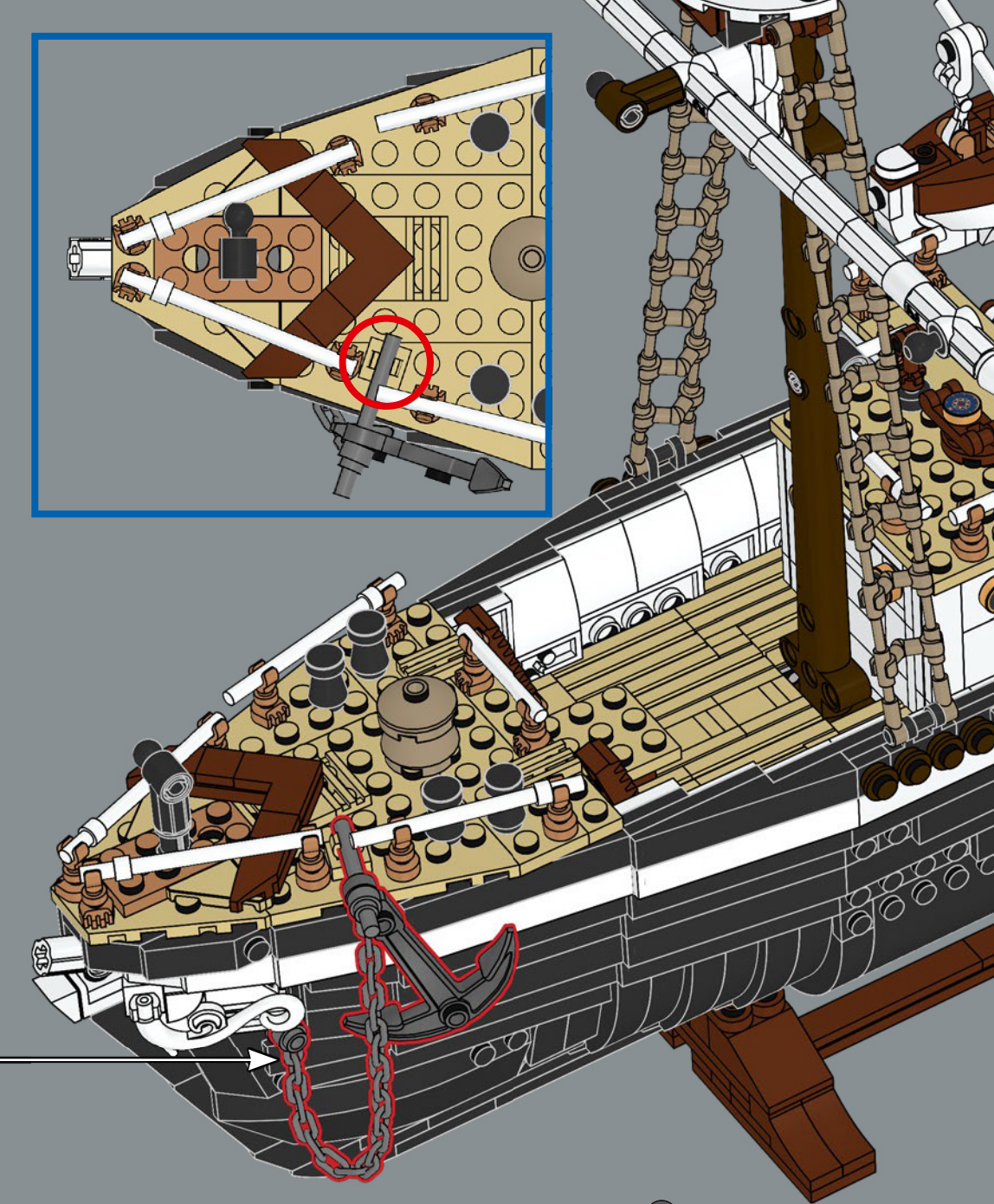
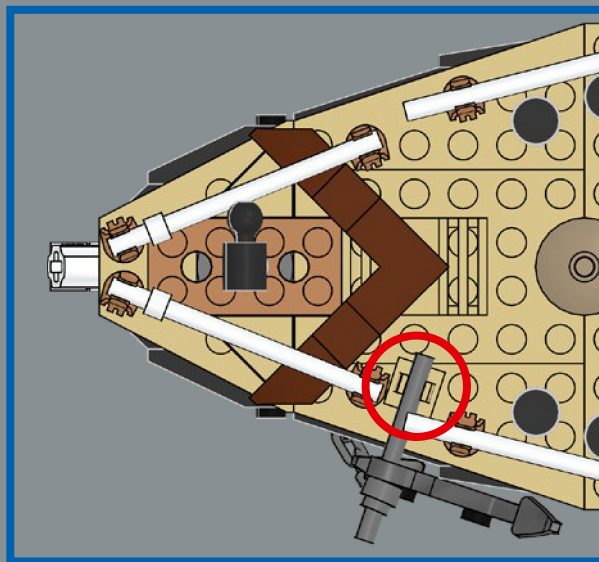
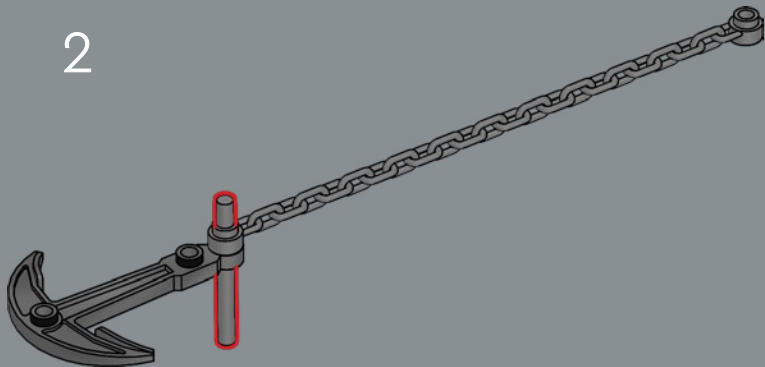

647

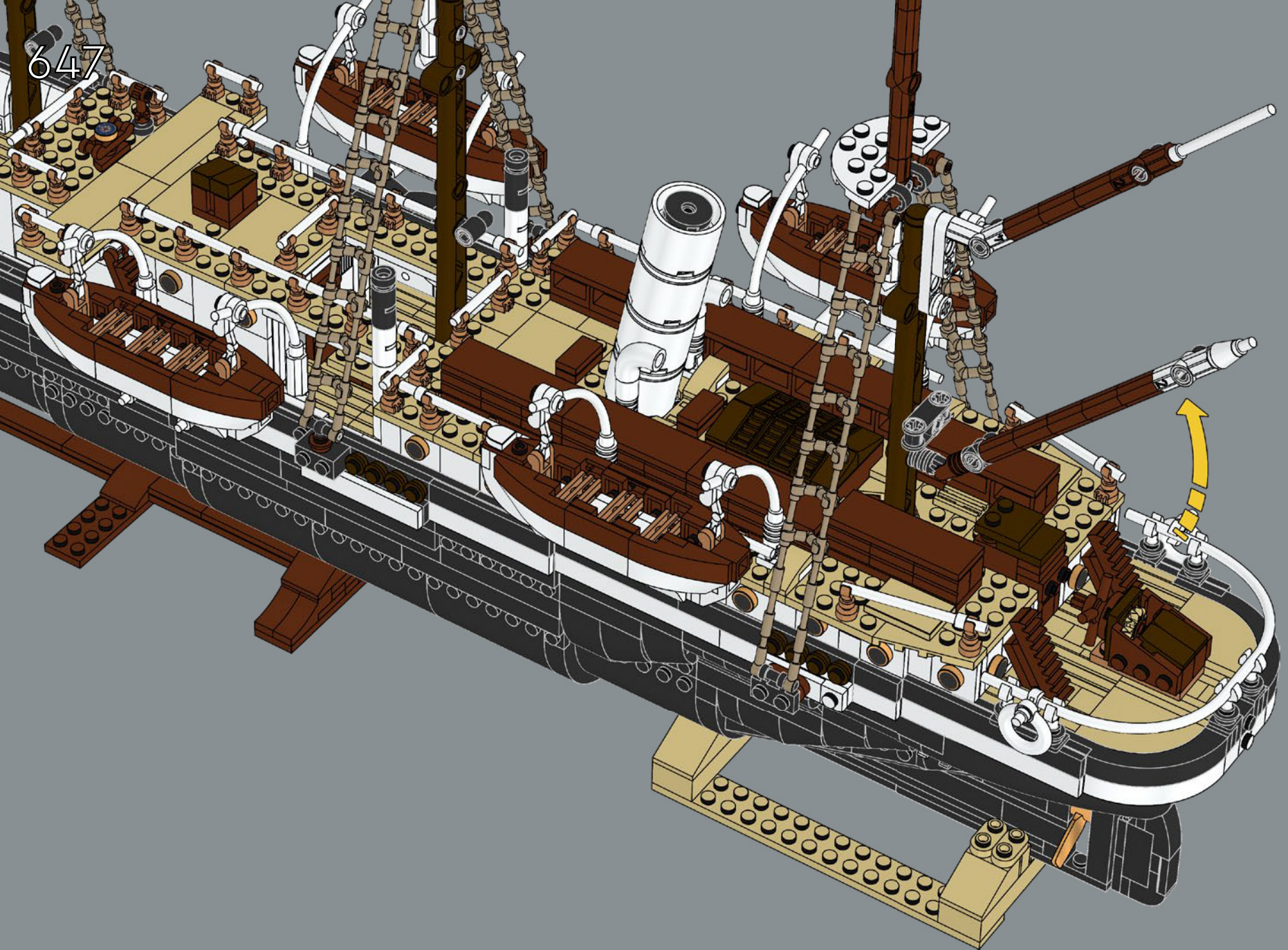

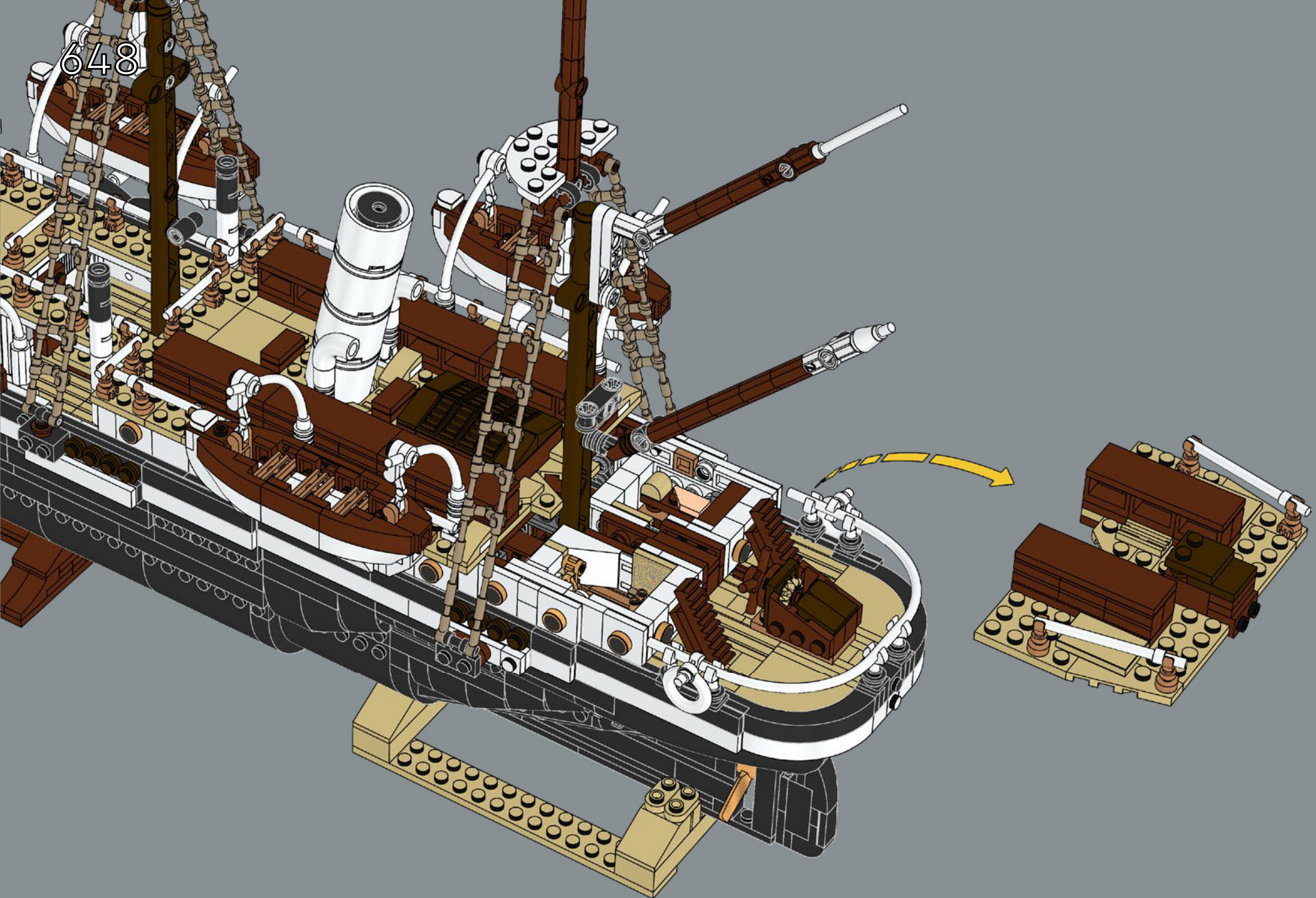

648

649

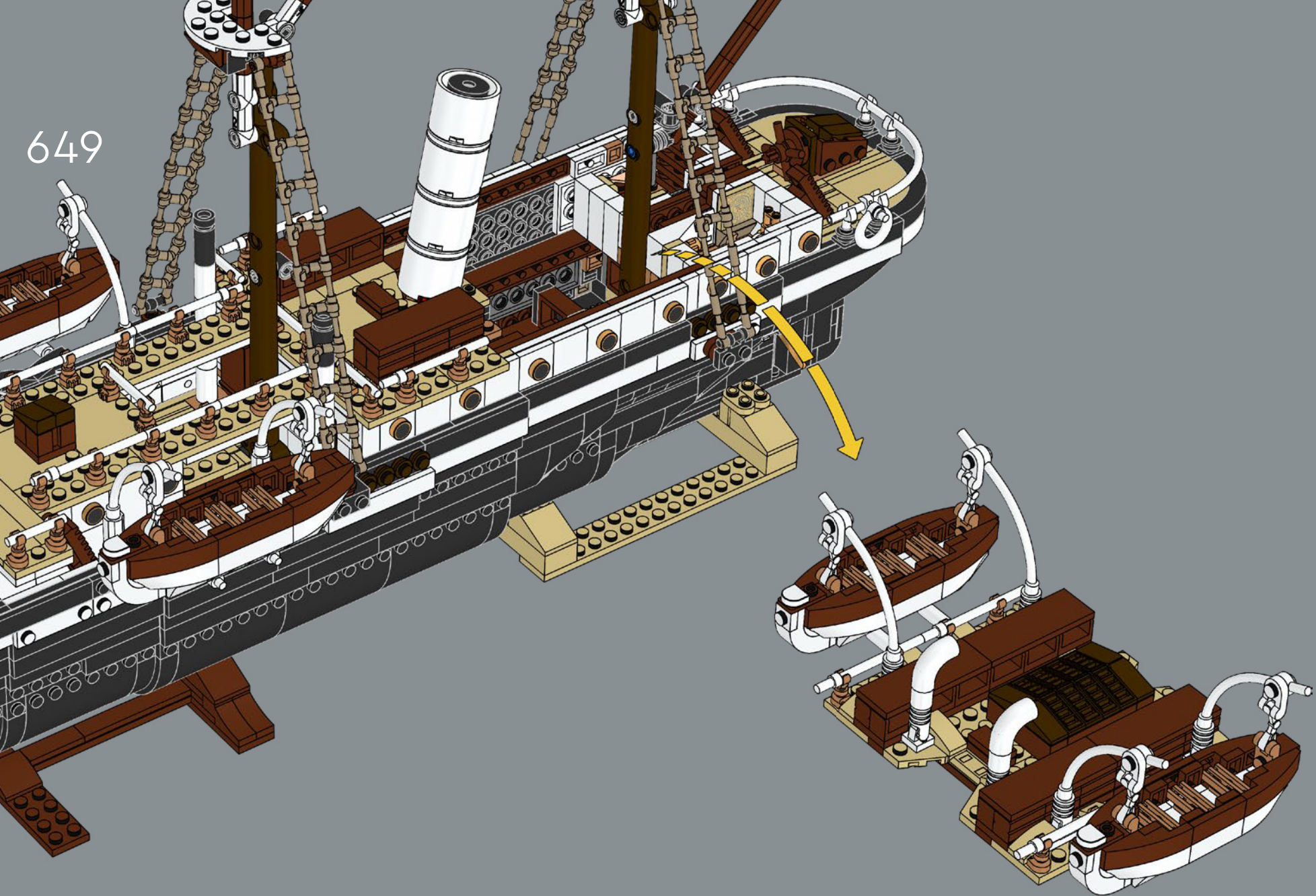

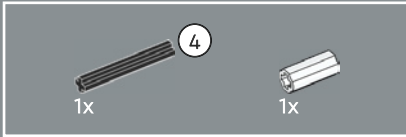
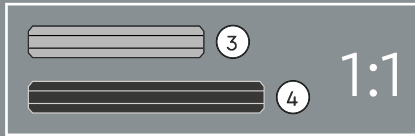
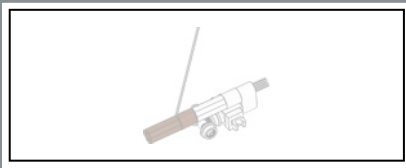

650

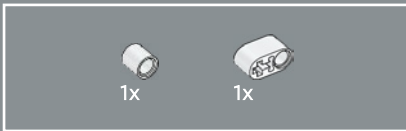
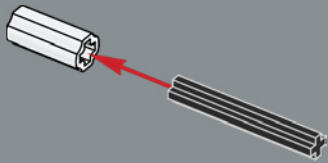

651

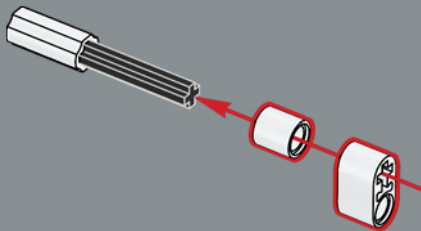

652

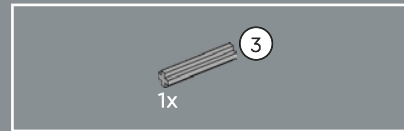
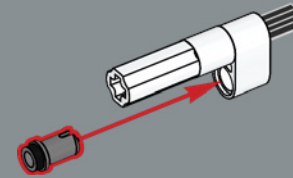

653

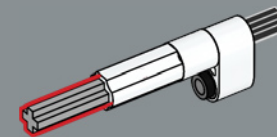

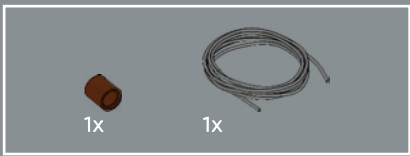

654

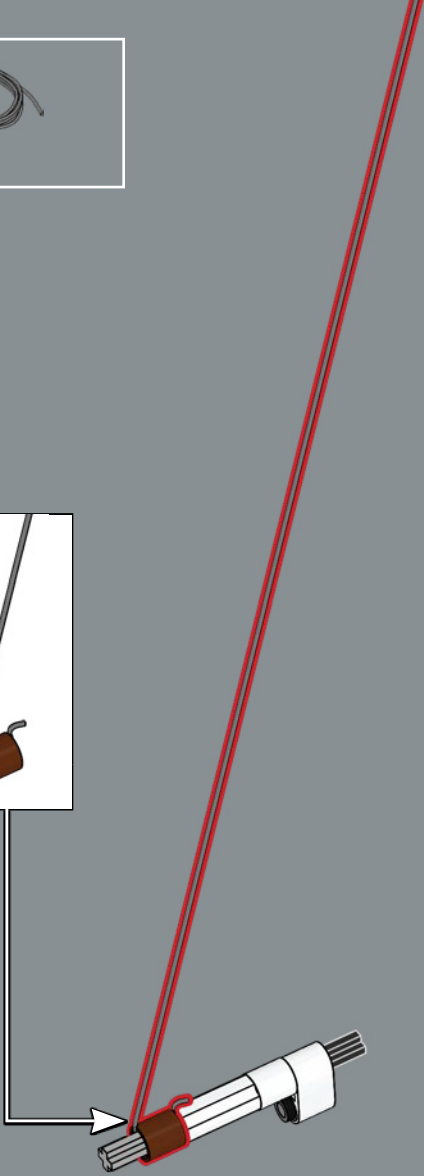
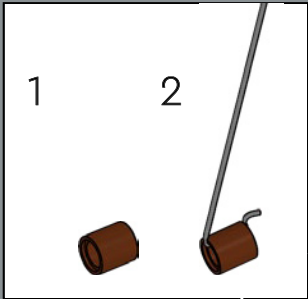

655

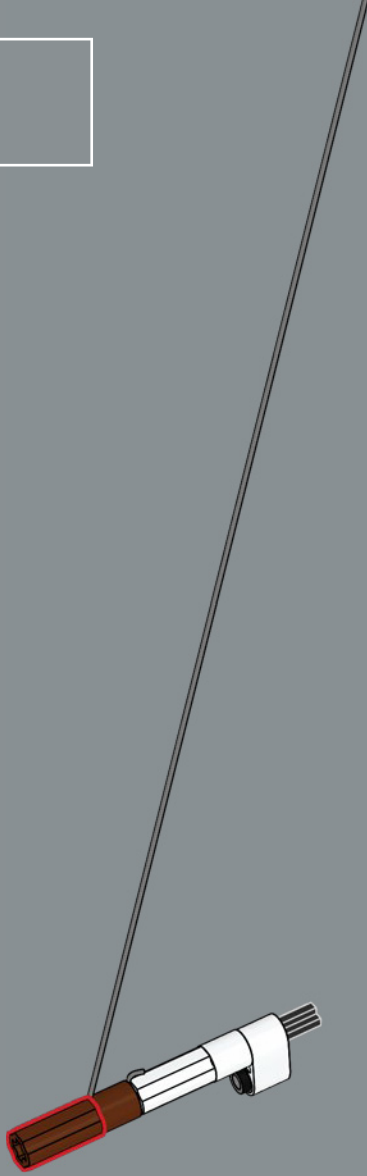

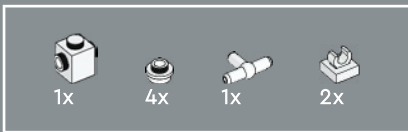

656

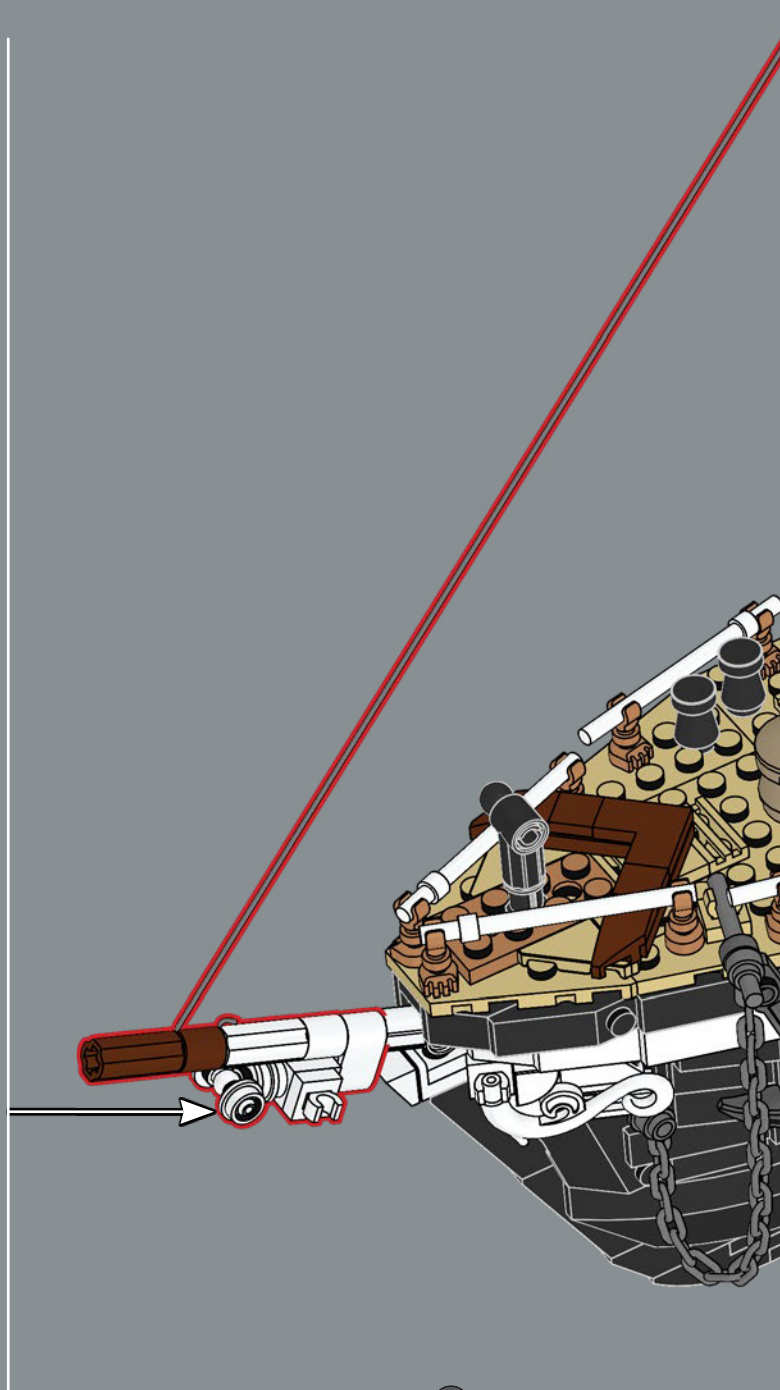
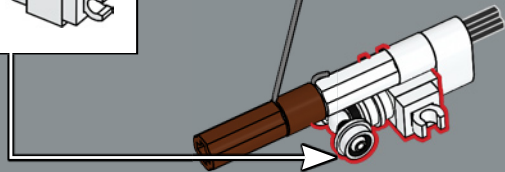
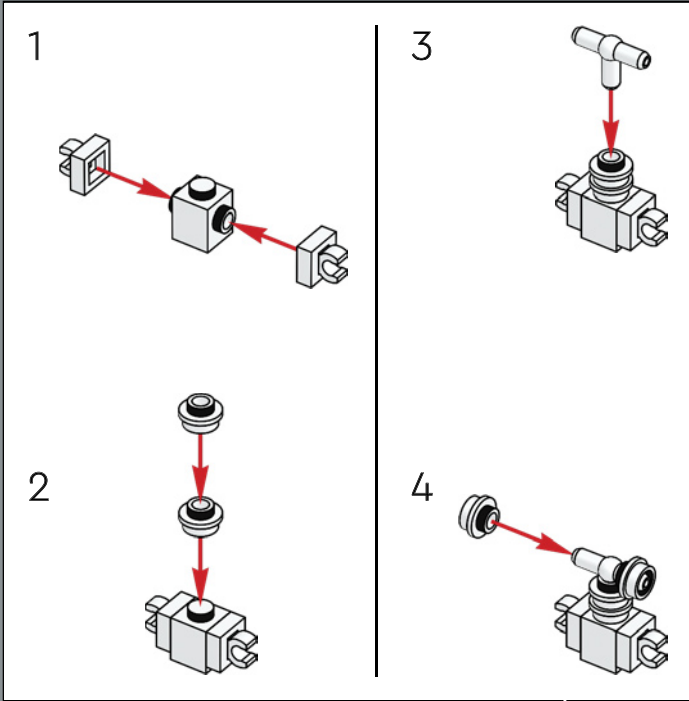



657

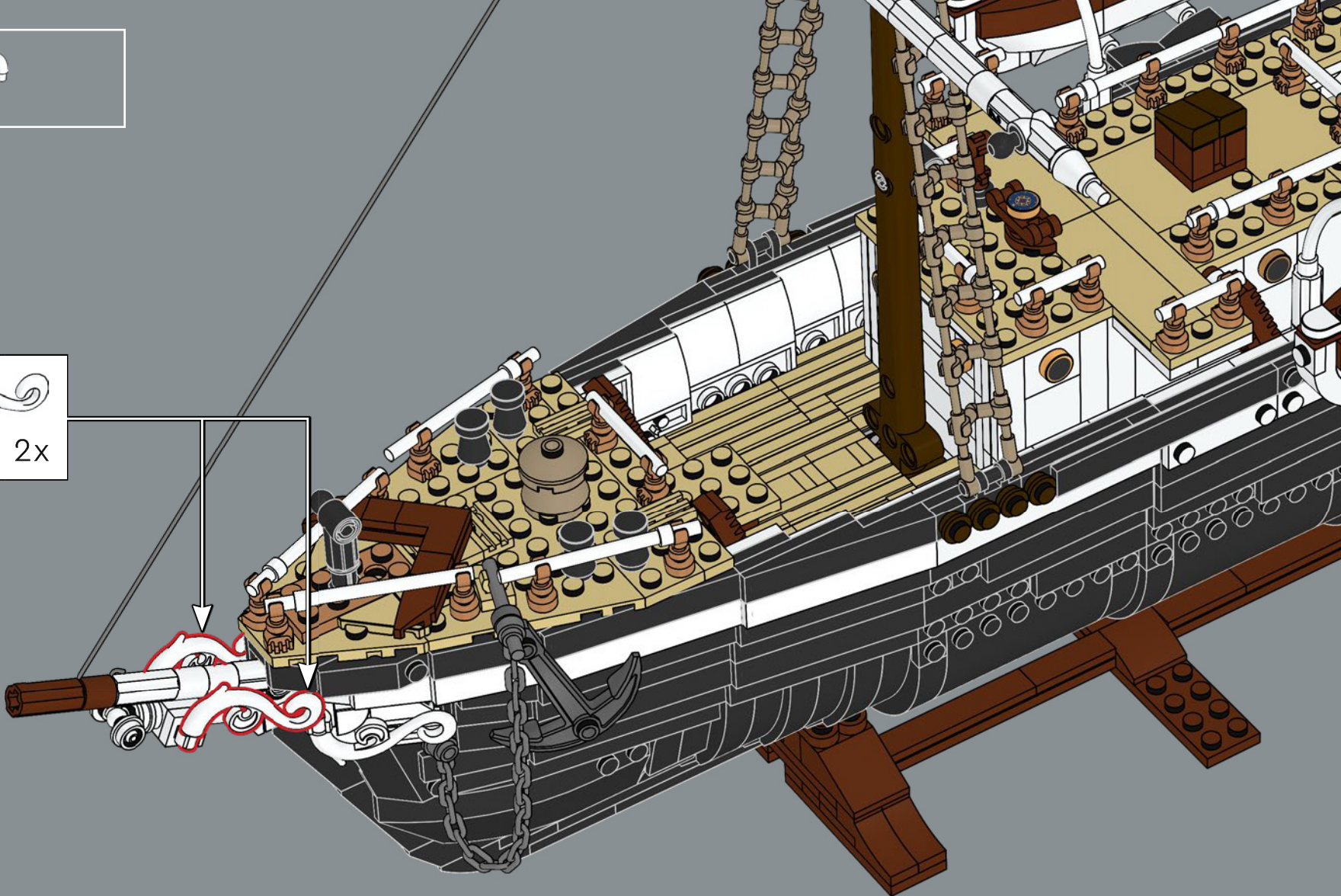
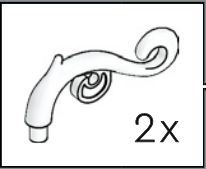

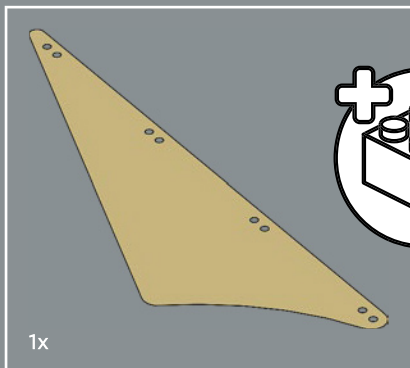

I tessuti LEGO® utilizzano gli stessi colori dei mattoncini LEGO. Per le vele, il marrone chiaro è stato considerato il colore più attraente e appropriato.

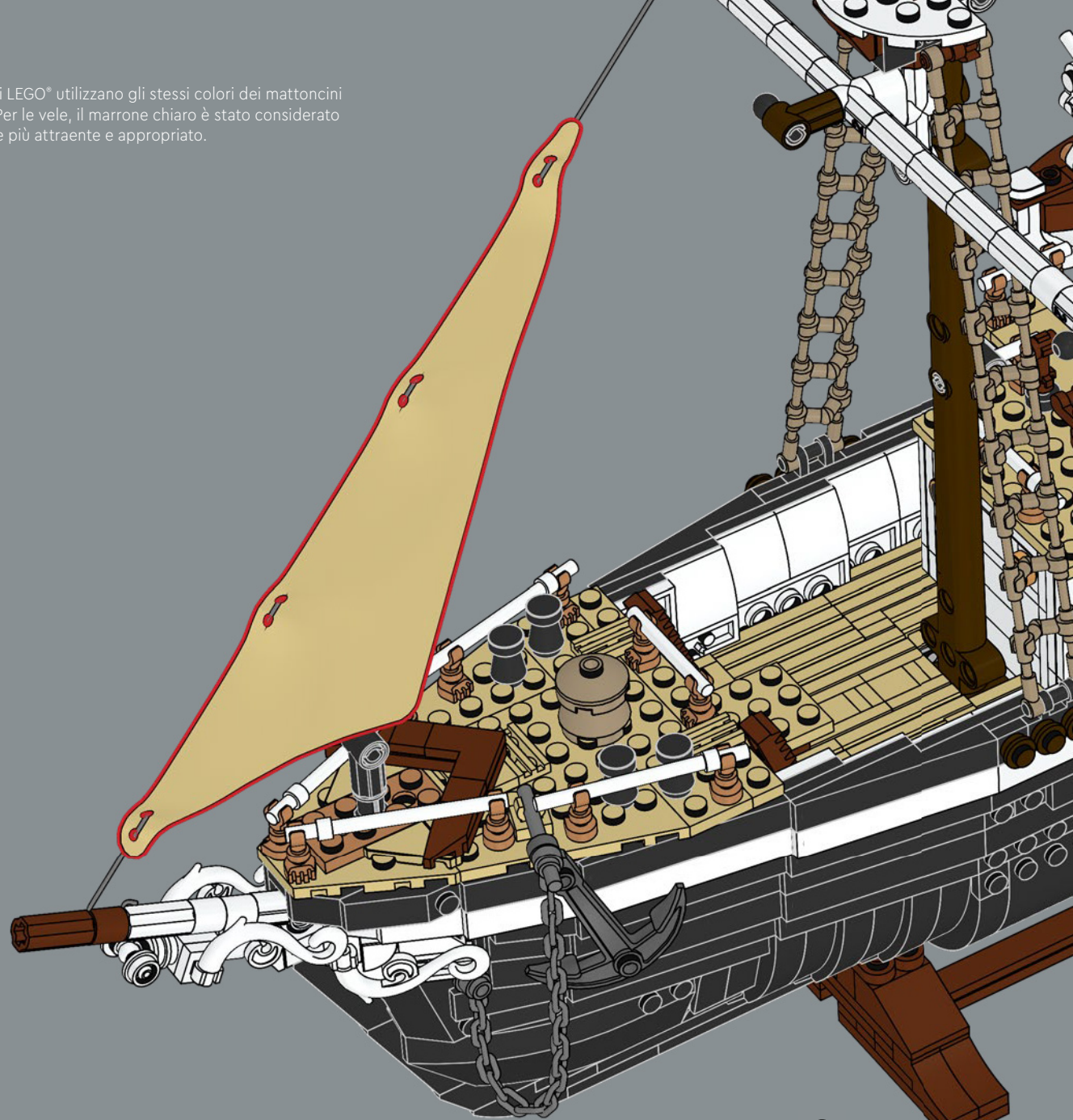

658



659

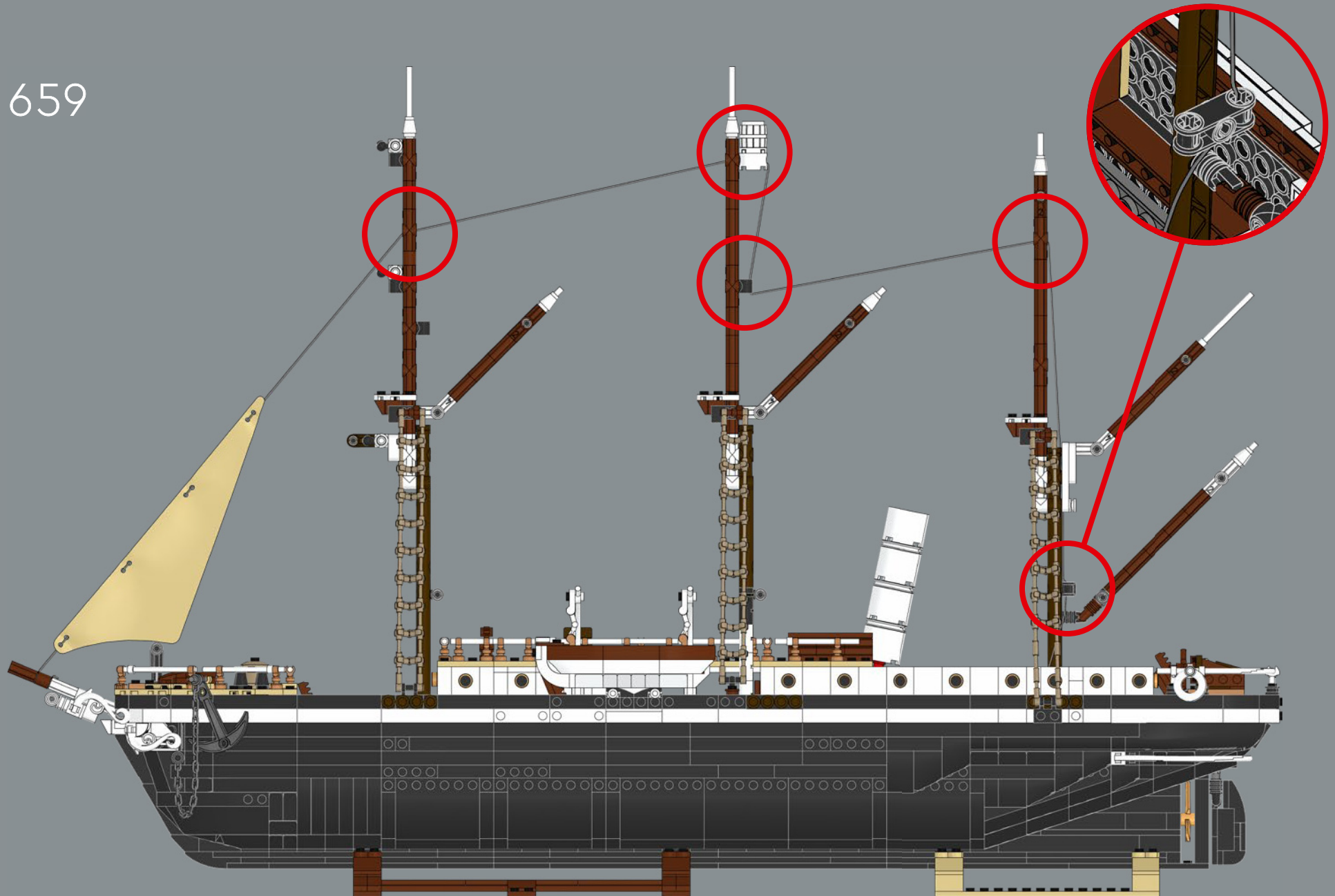

1x



660

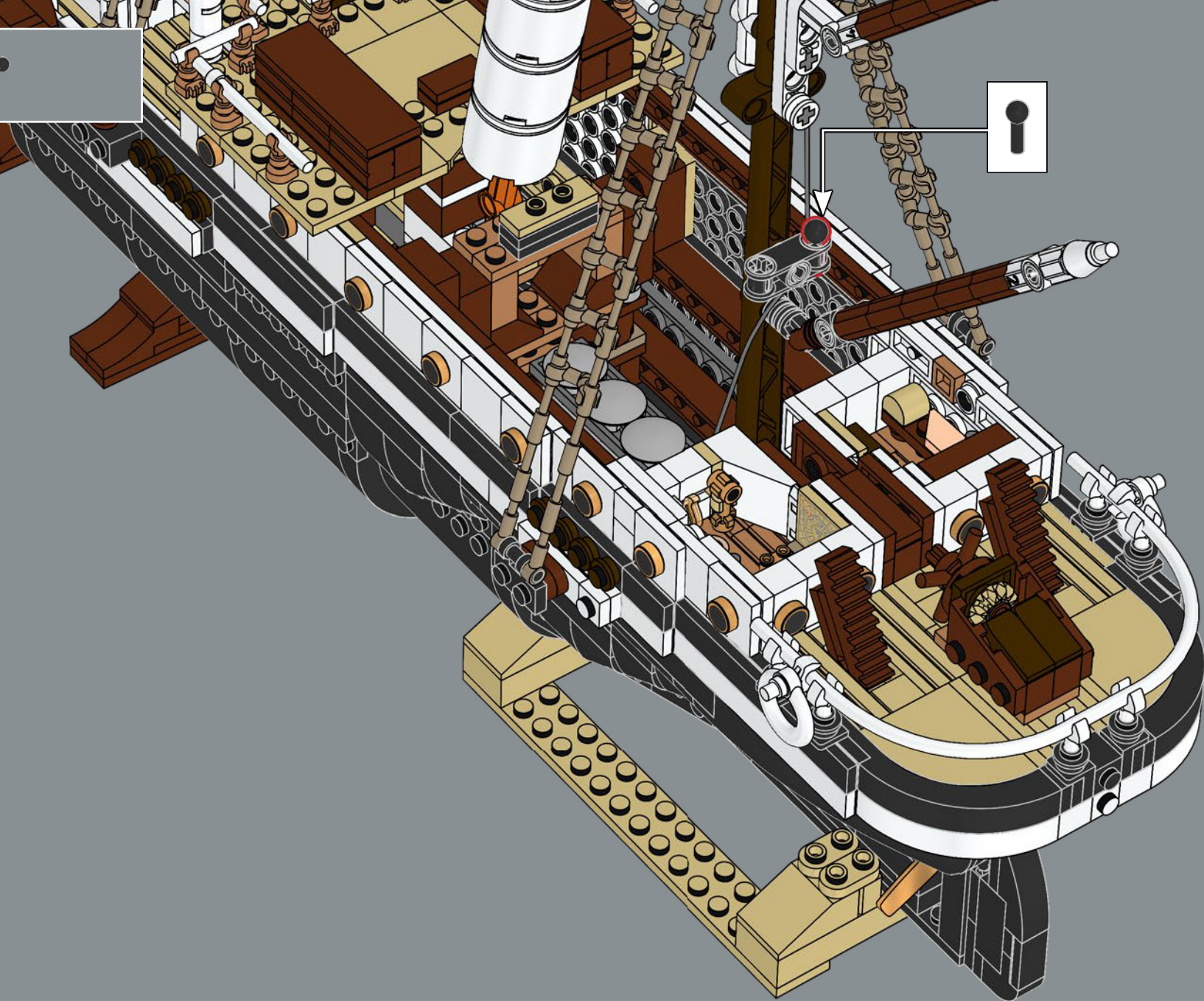

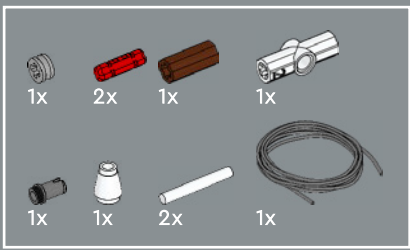

661

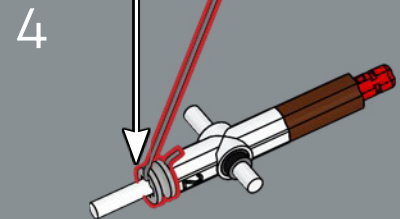
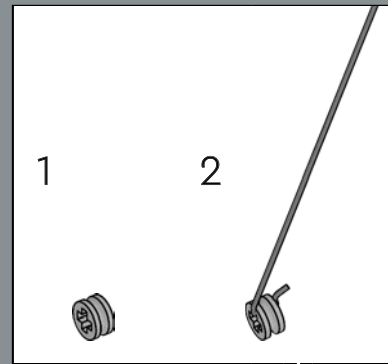
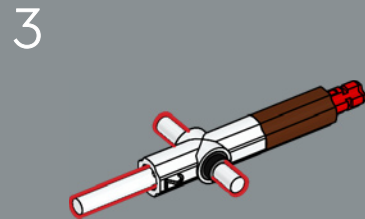
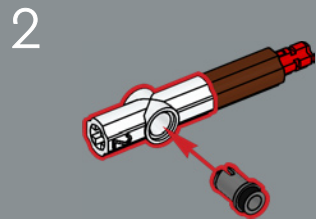
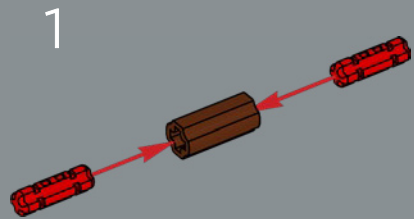

5

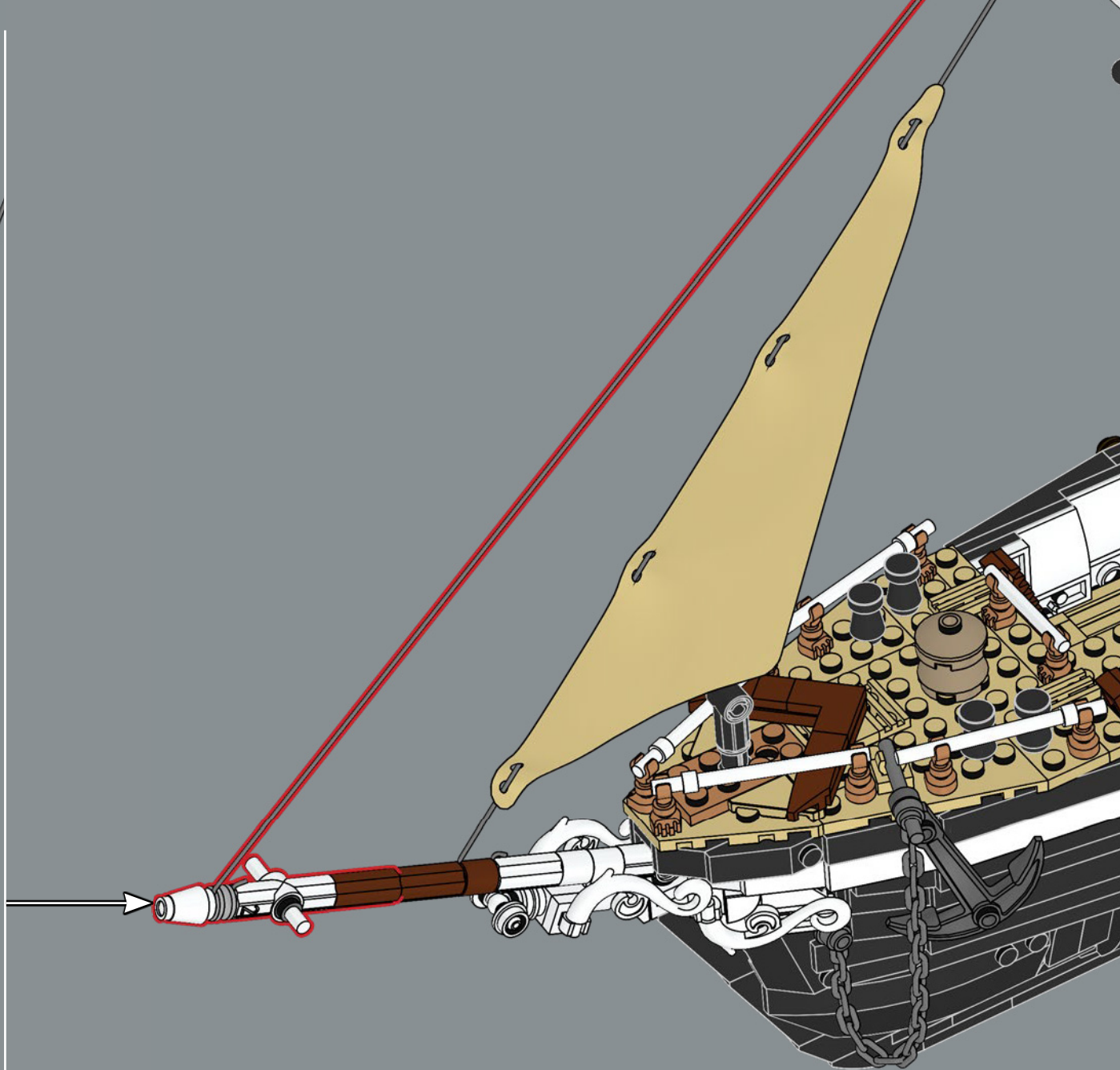
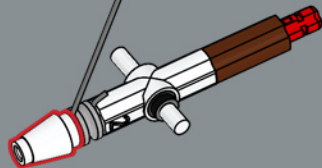

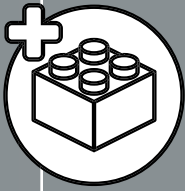
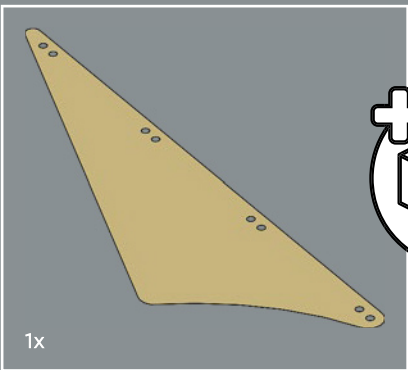

662

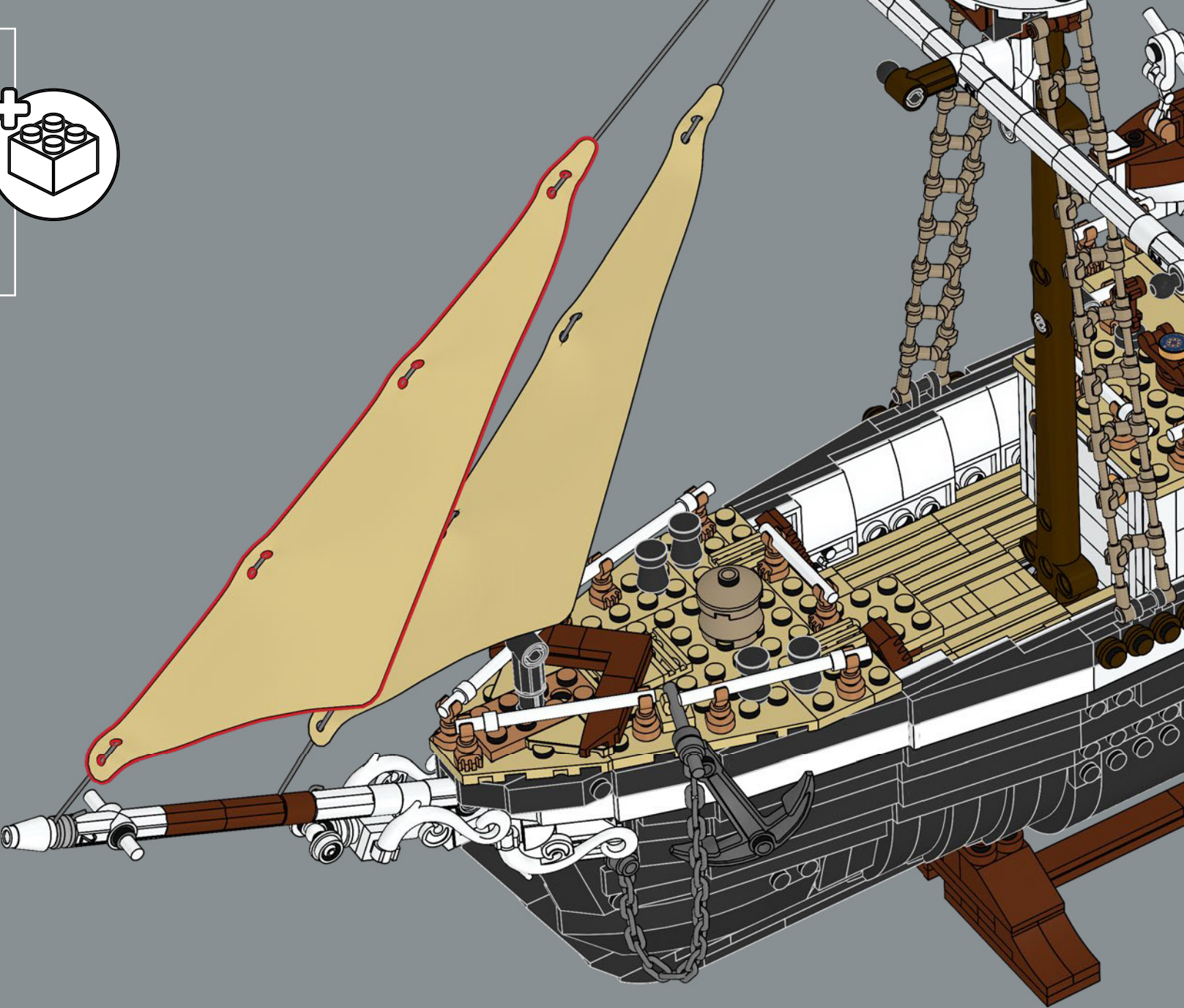

663

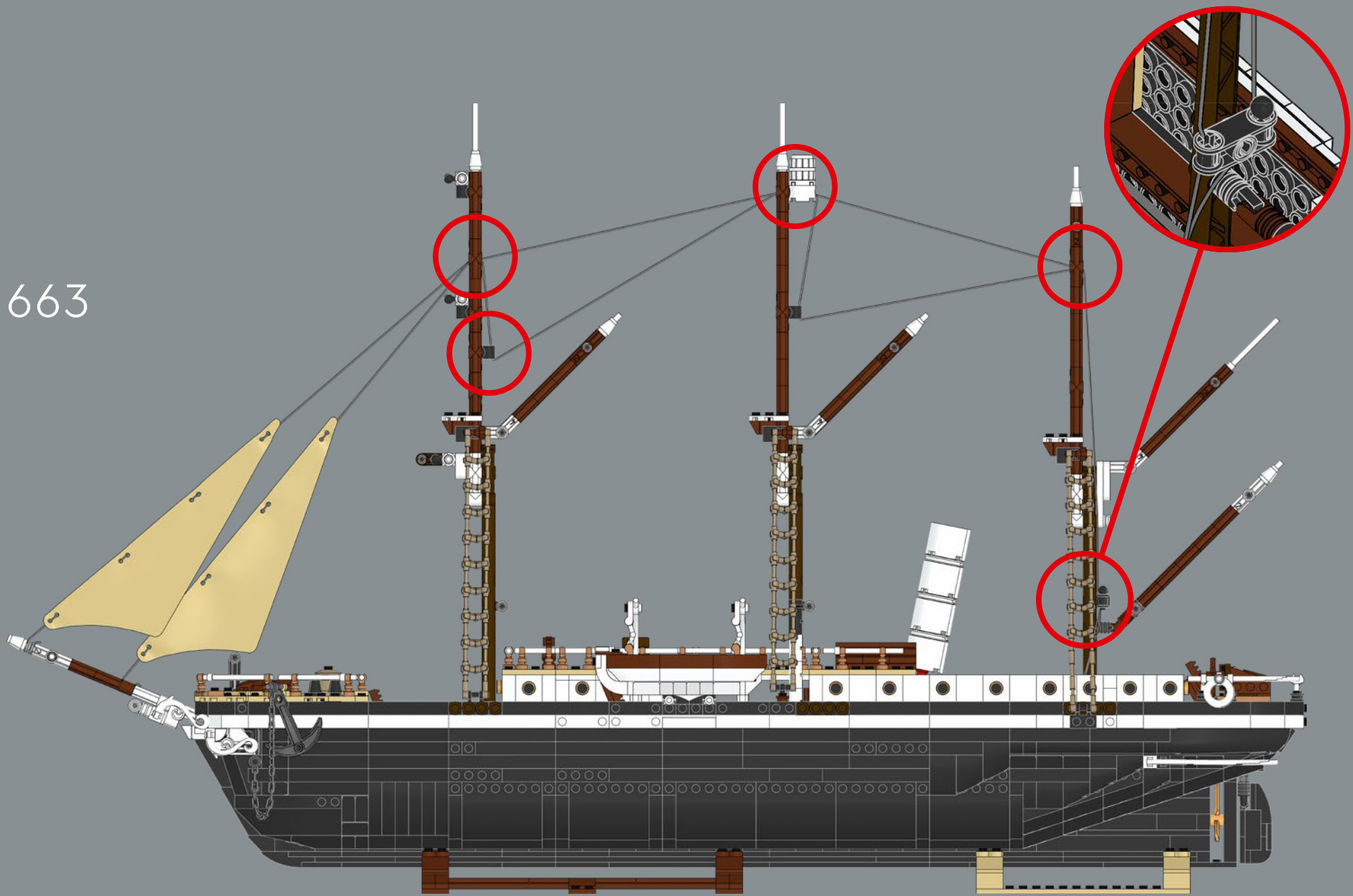



1x

664



Gli elementi corda LEGO® sono tagliati a caldo per evitare che le estremità si sfilaccino. Per questo modello abbiamo trovato una soluzione senza nodi e senza tagli, con la corda in eccesso avvolta intorno a una bobina, nascosta sottocoperta.

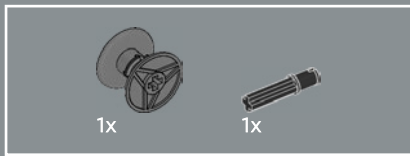

665

1

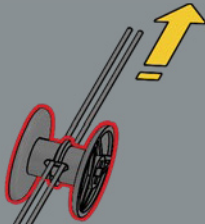

2

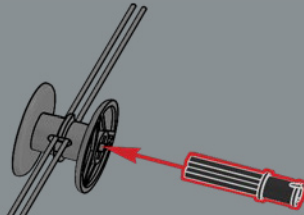

3

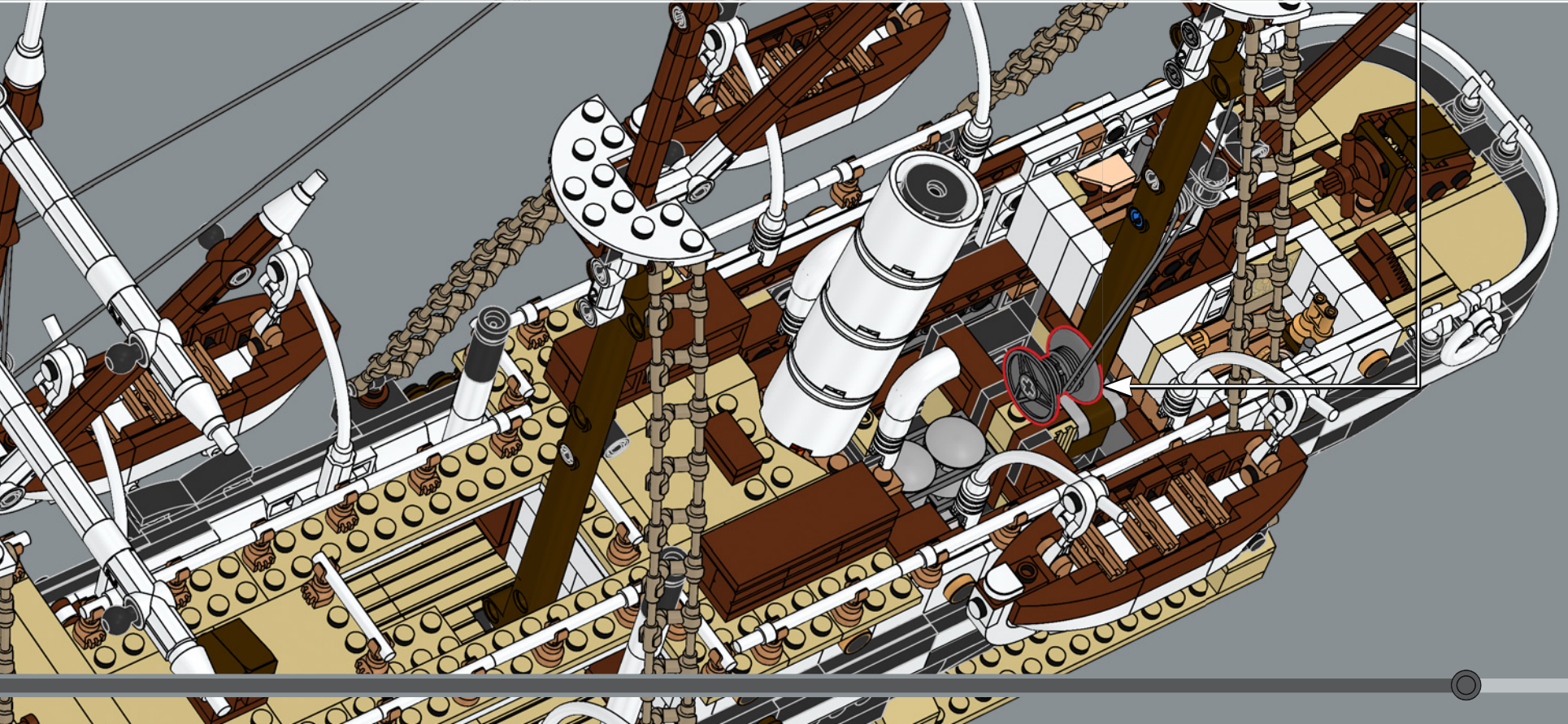
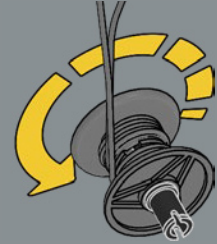

666

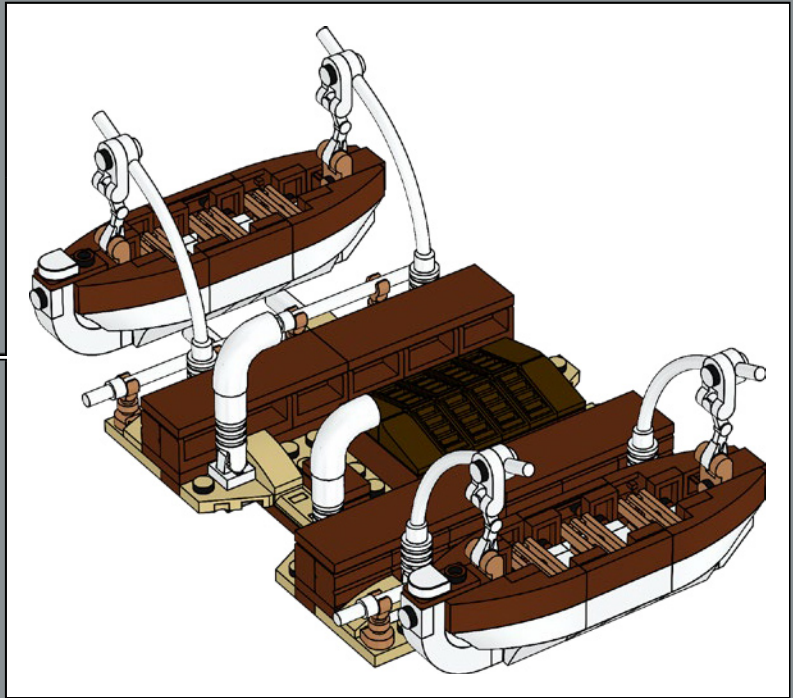
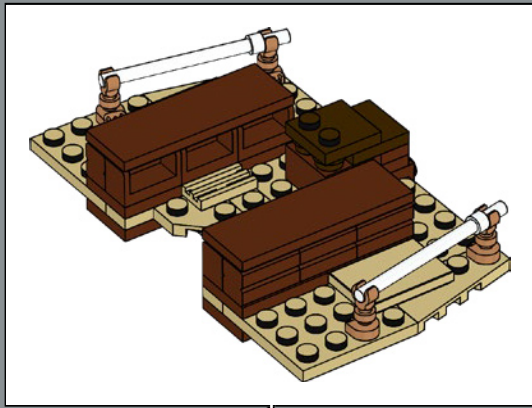
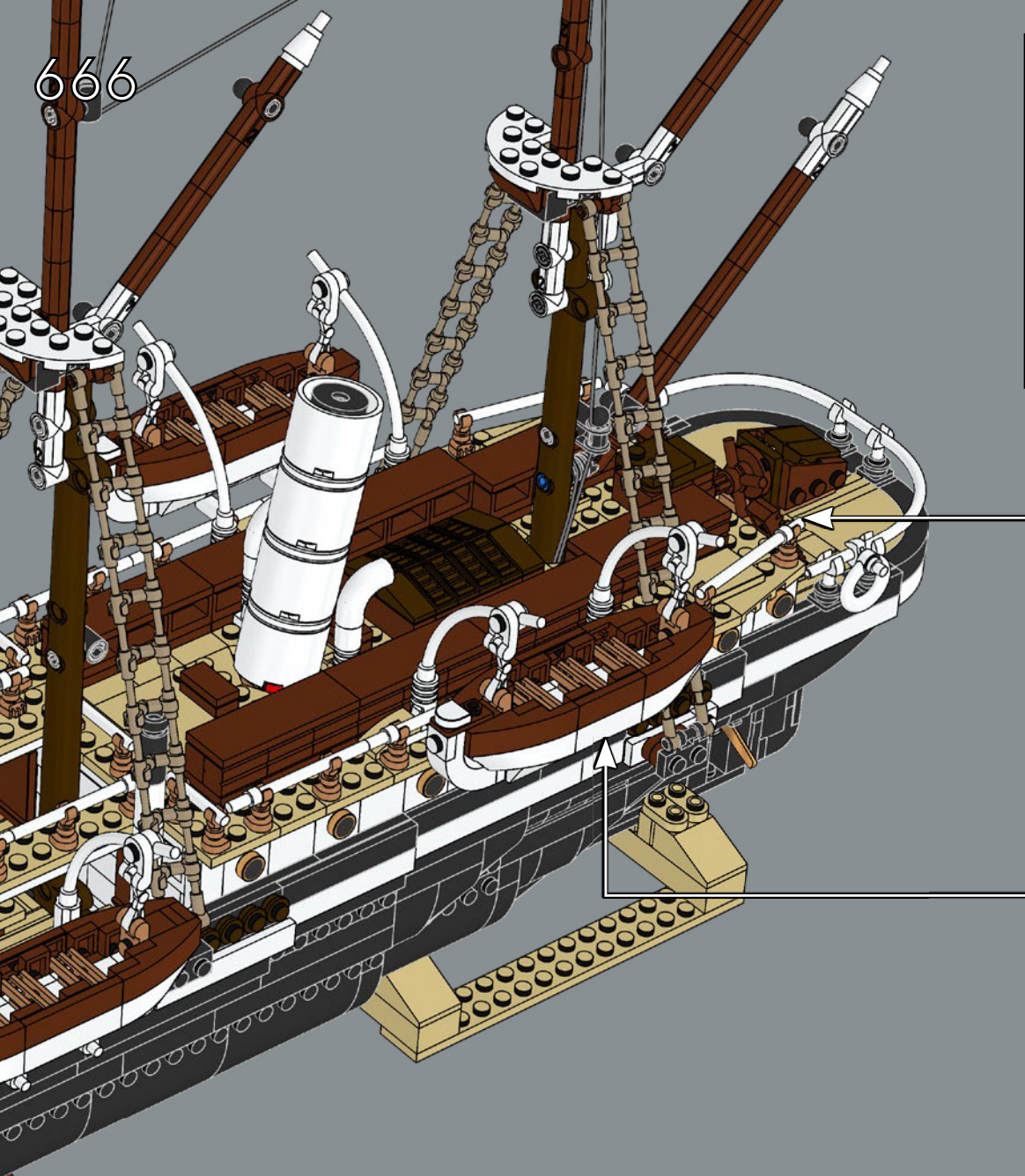

667

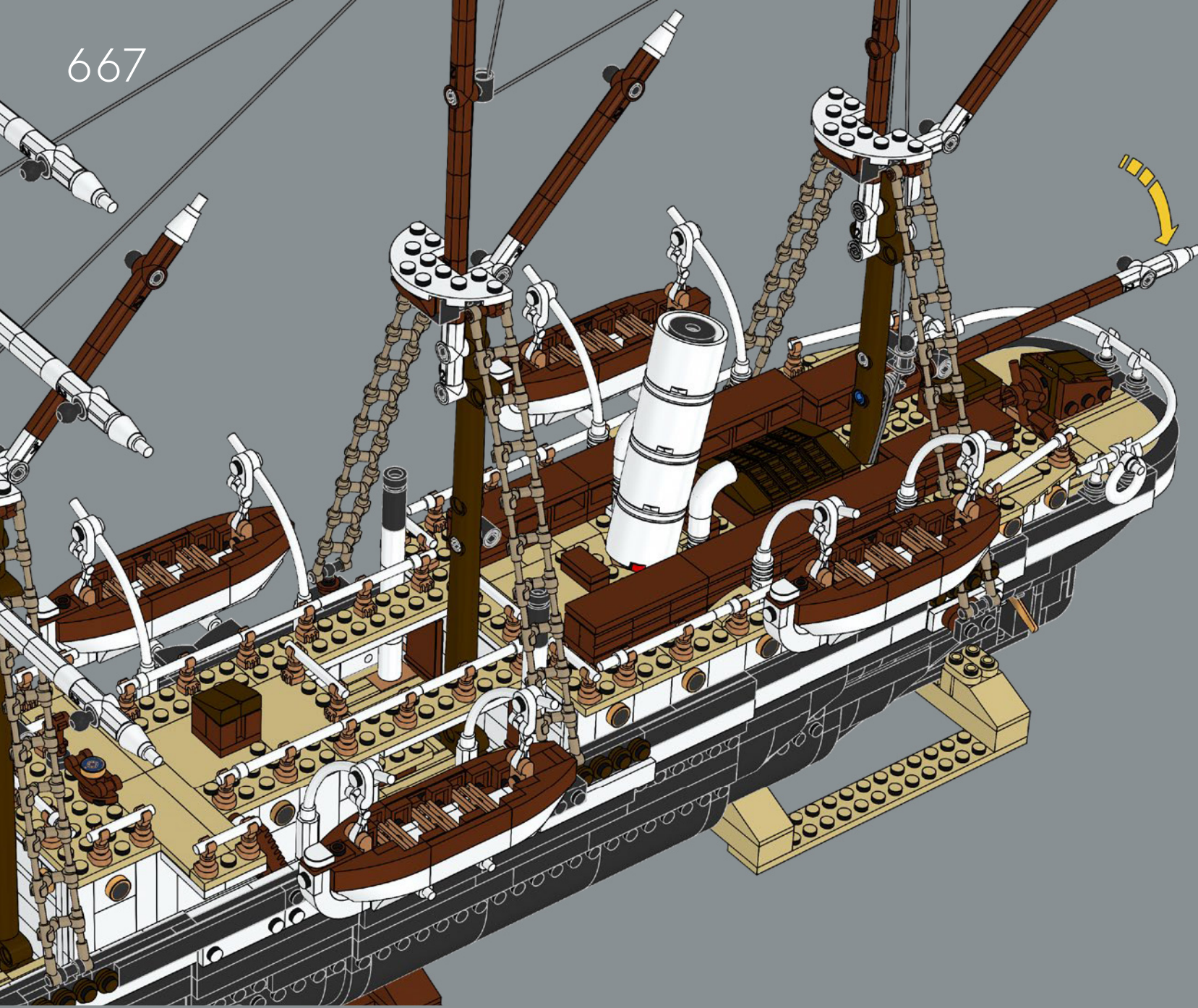



668

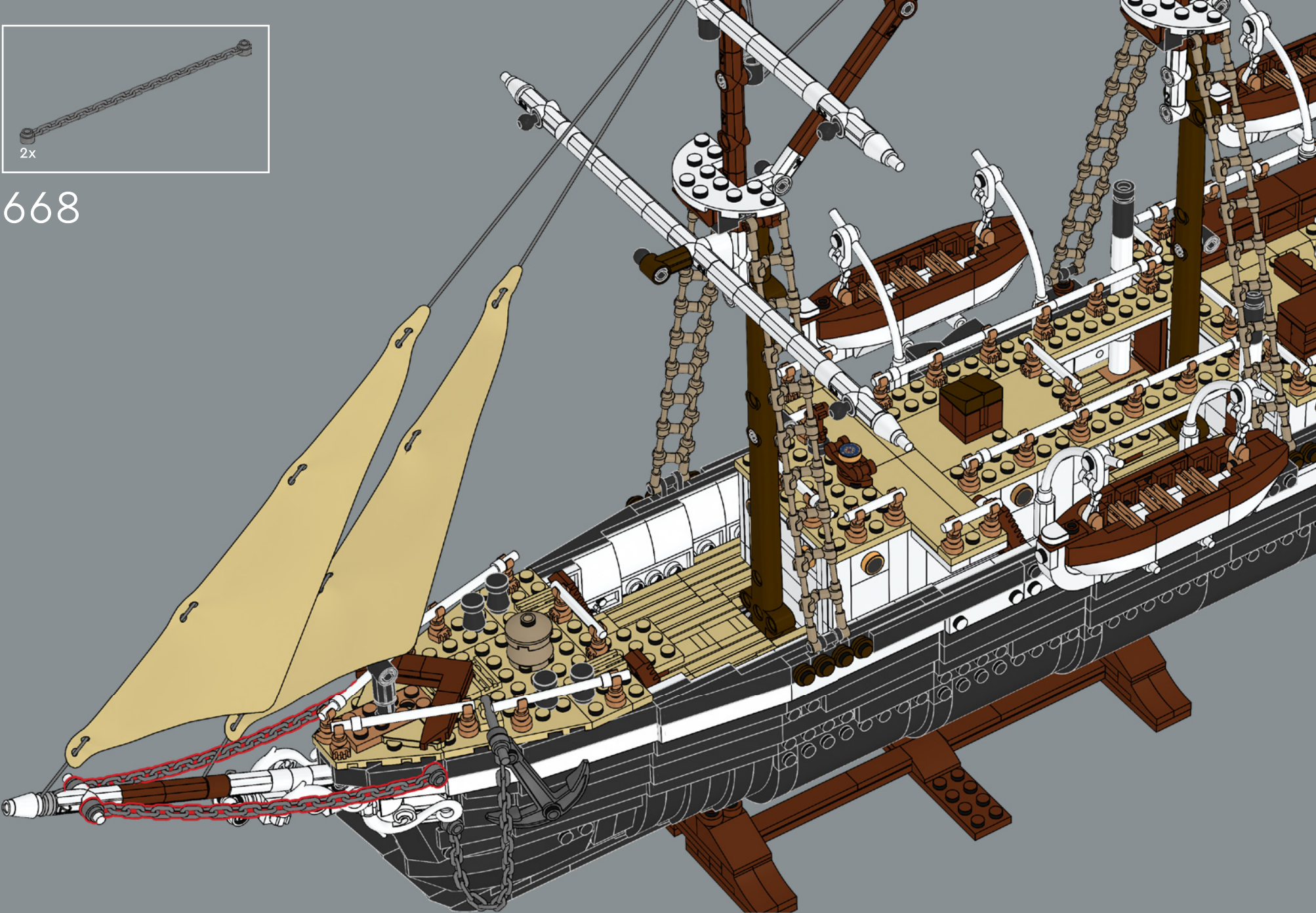

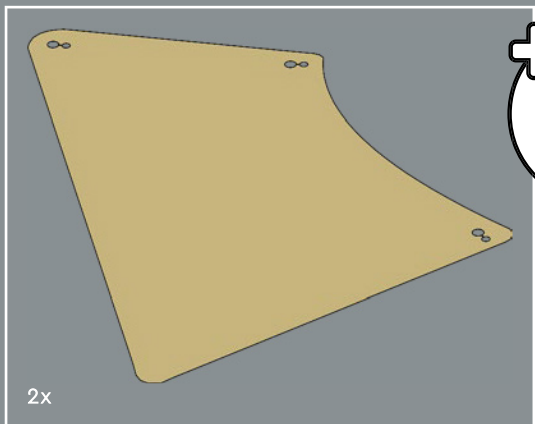

669



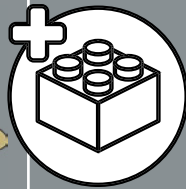
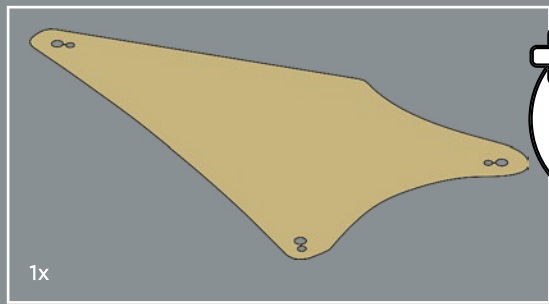

1x

670

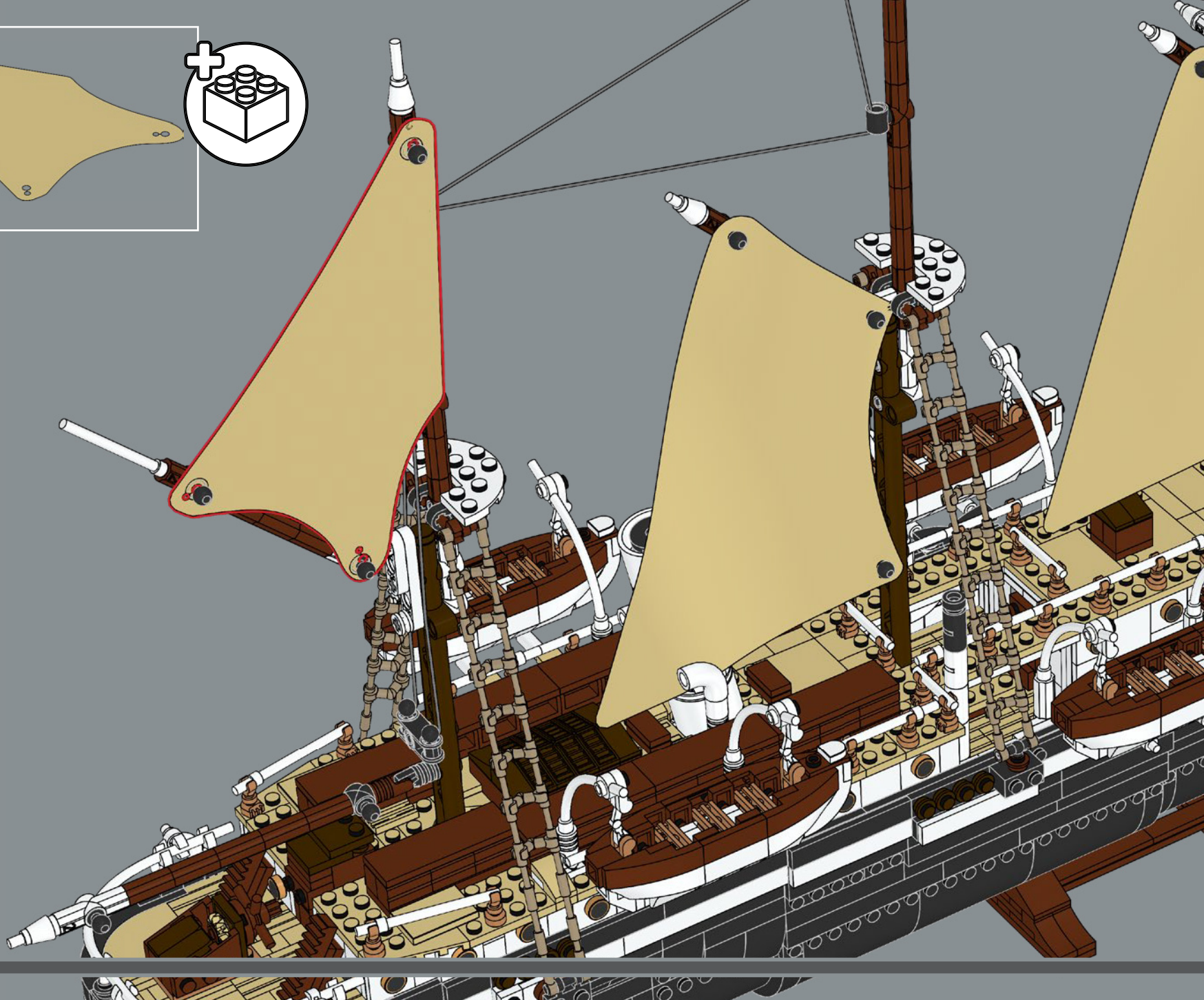



1x

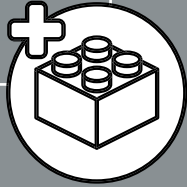

671



Questa bandiera britannica è chiamata "Red Ensign" ed era la bandiera che i mercantili e le navi private battevano in quel periodo.



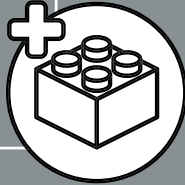
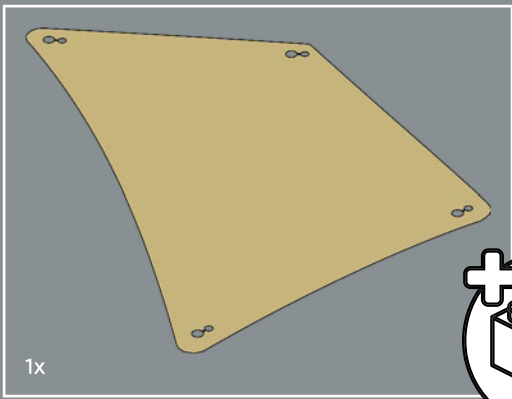

1x

672

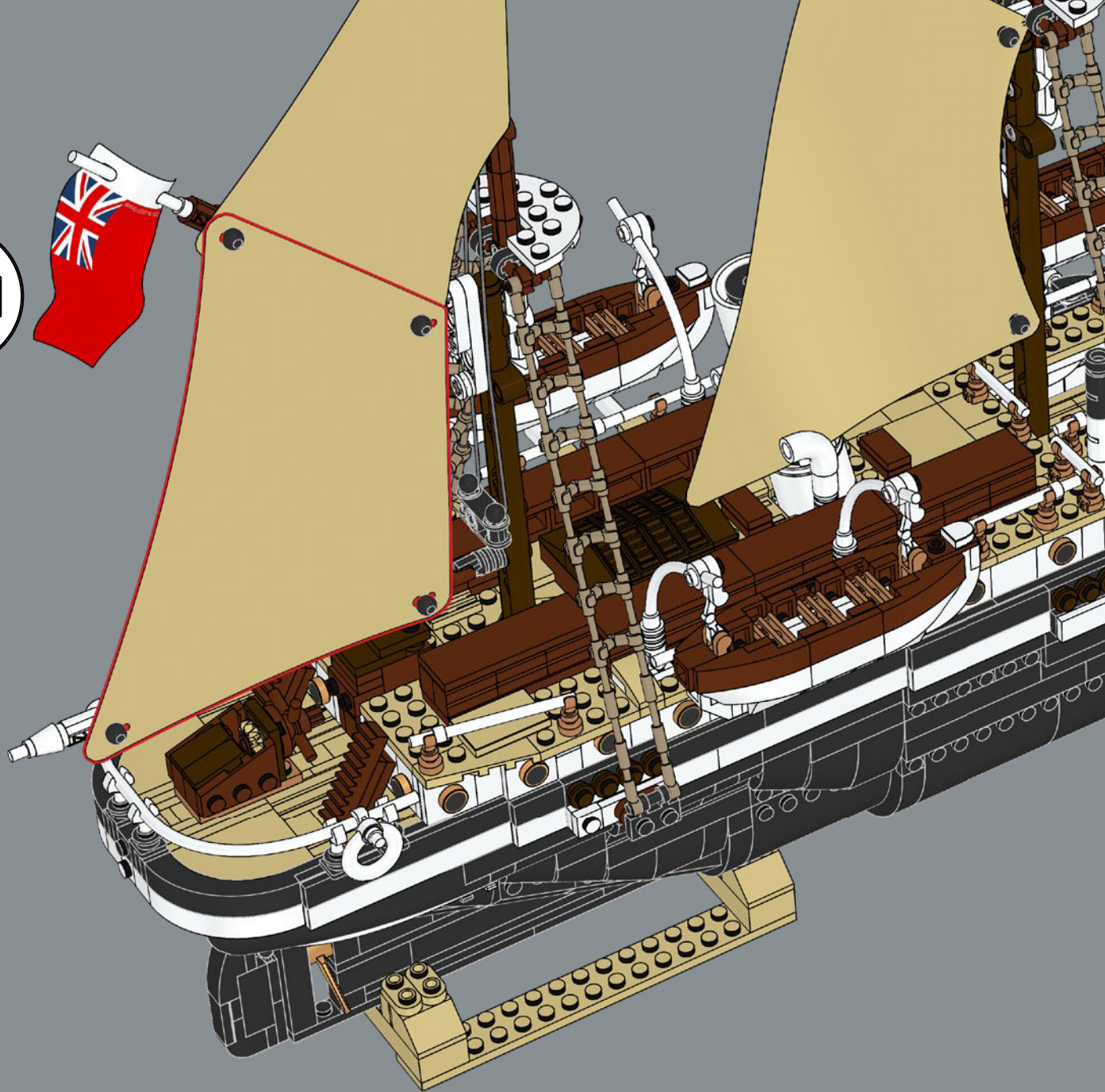

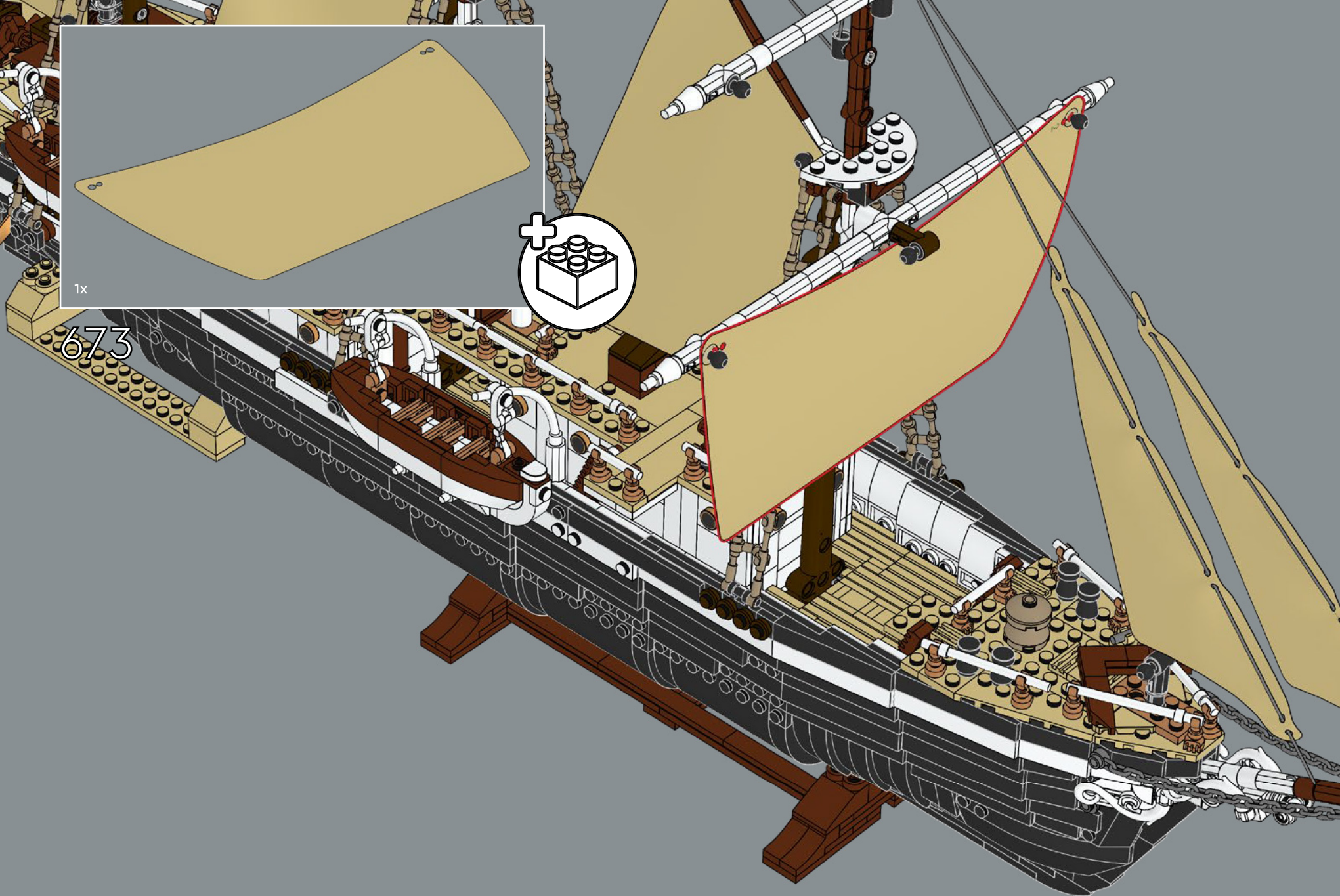

1x

673

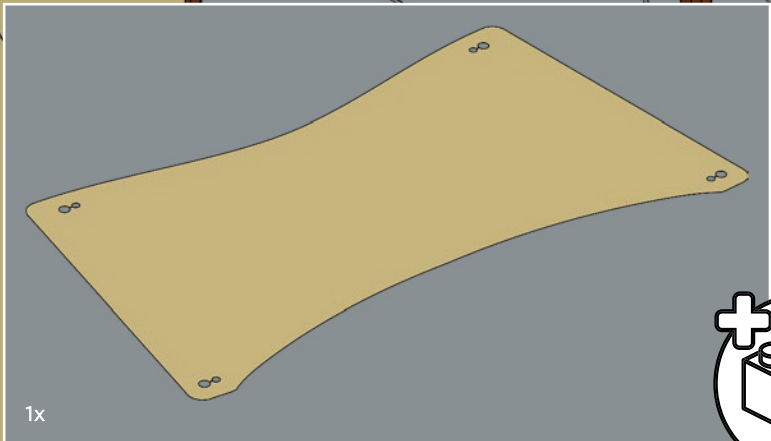

1x

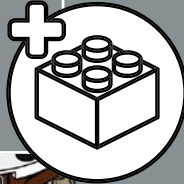

674

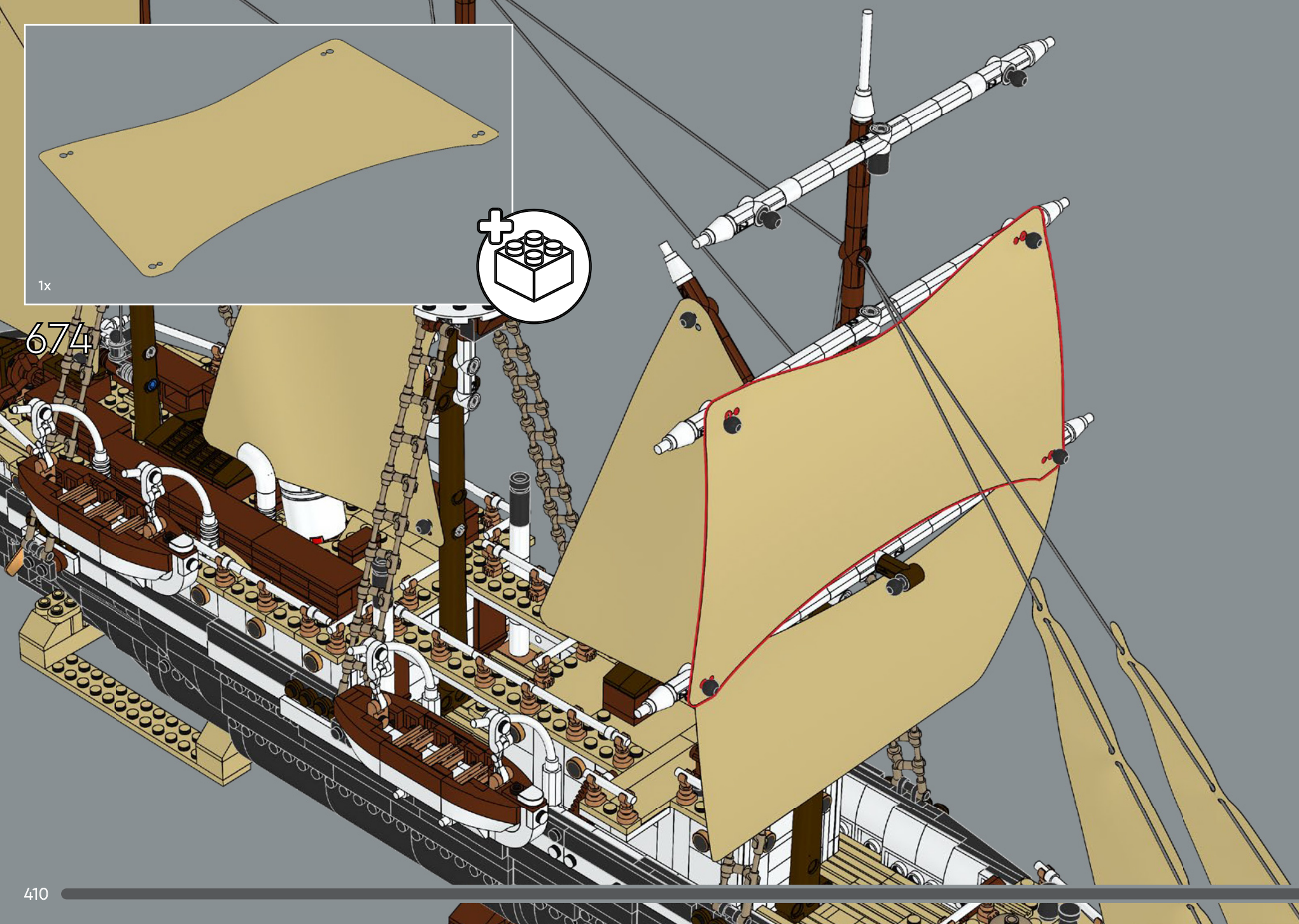

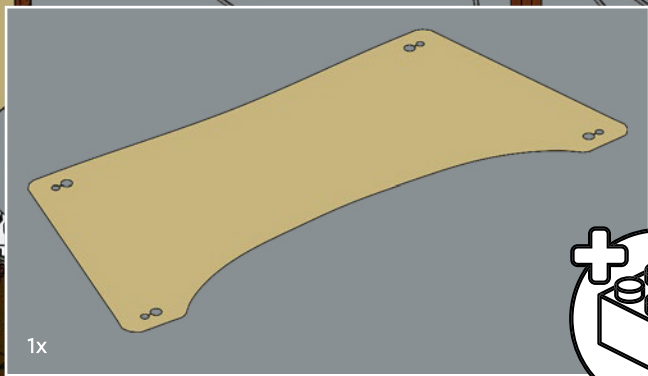

1x

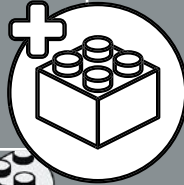

675

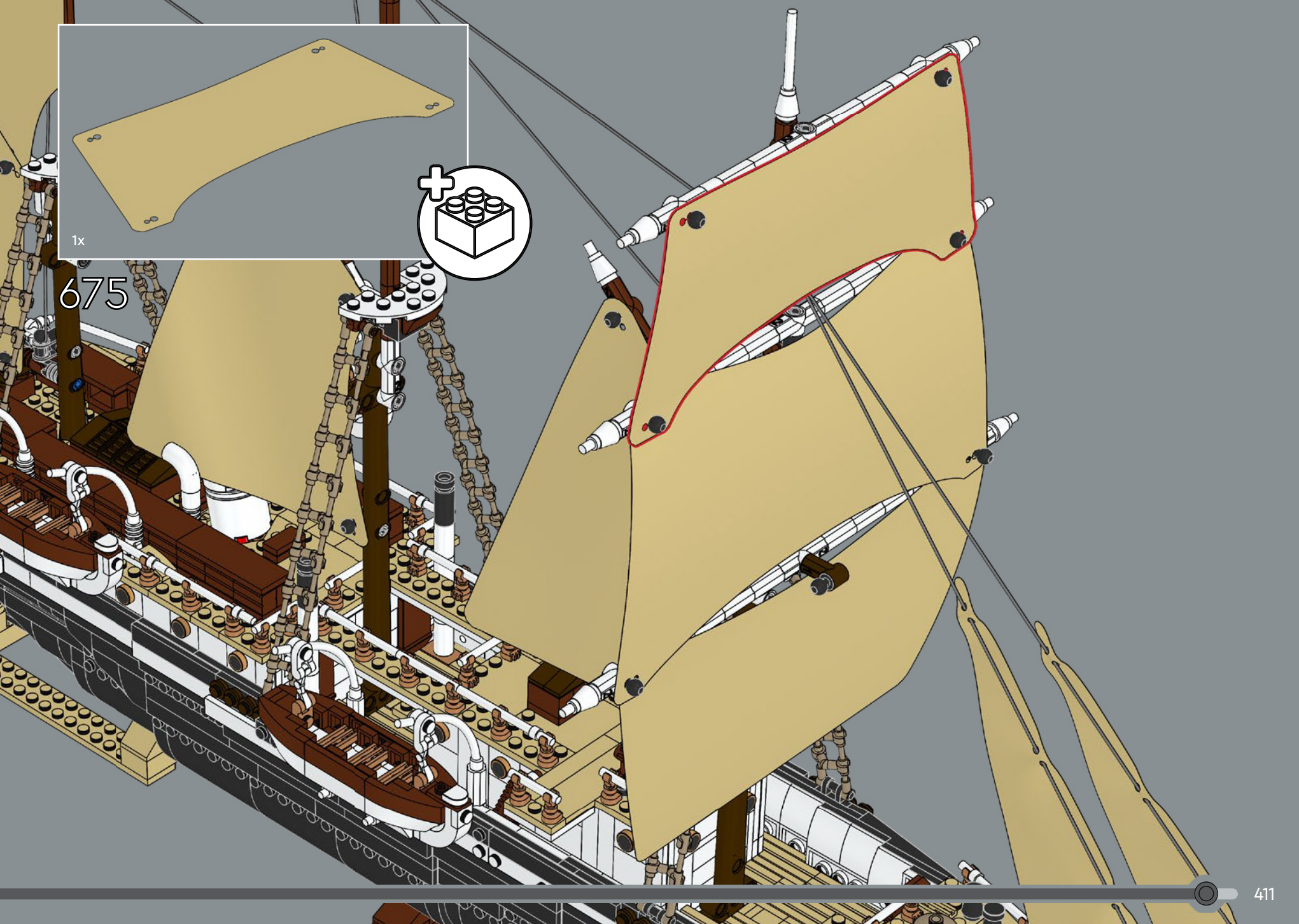

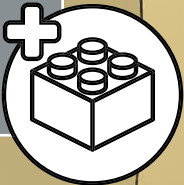
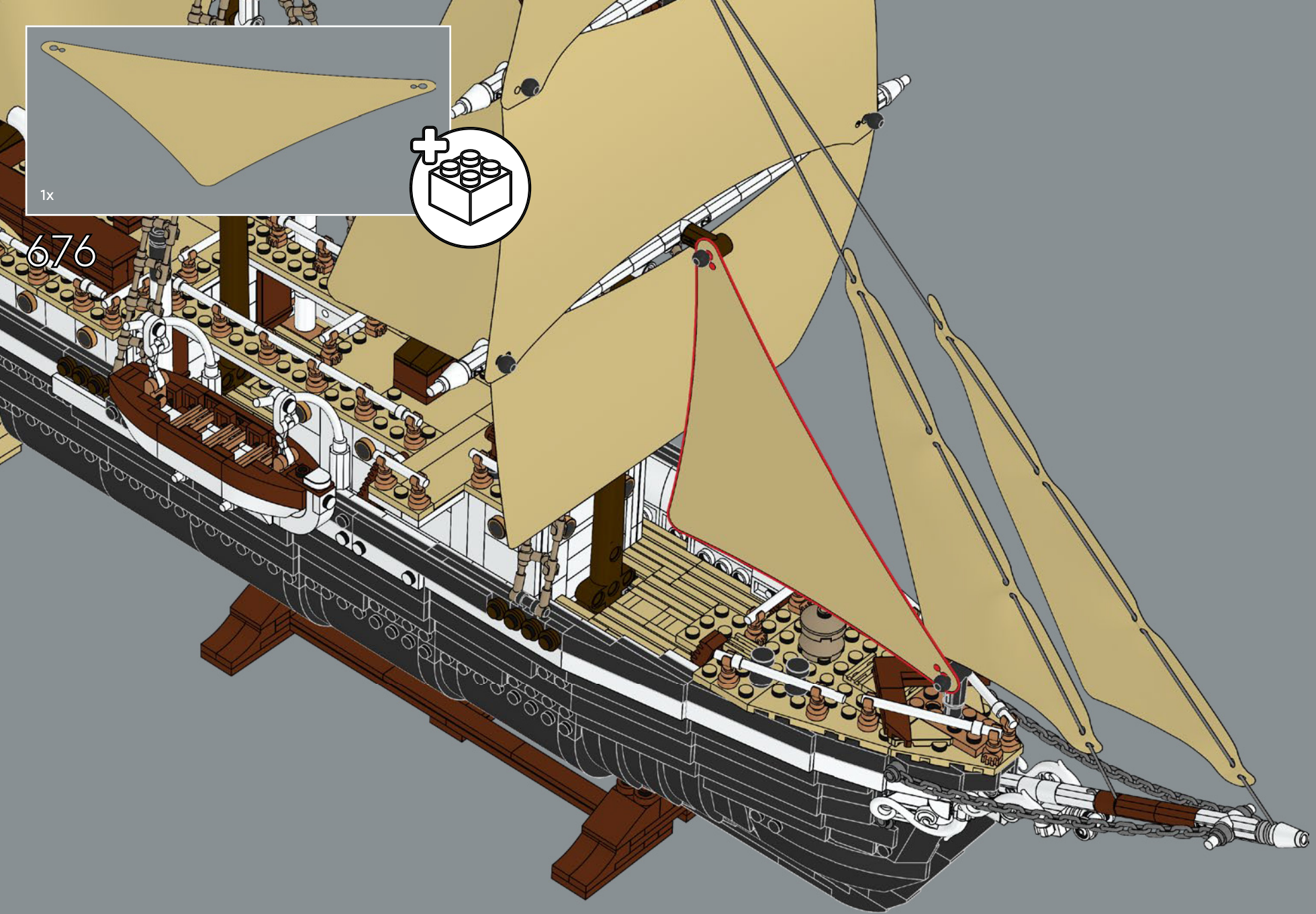

1x

676

677

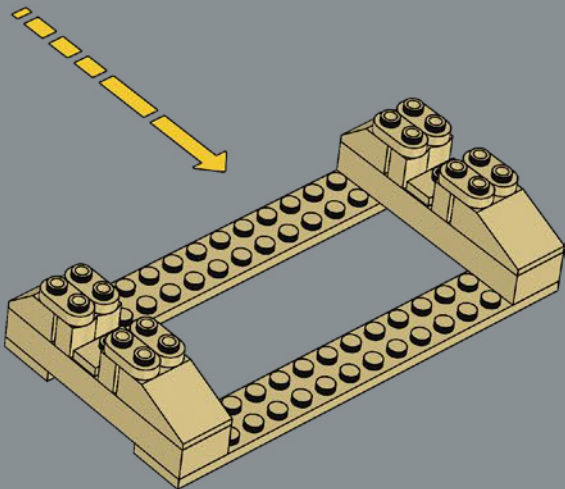
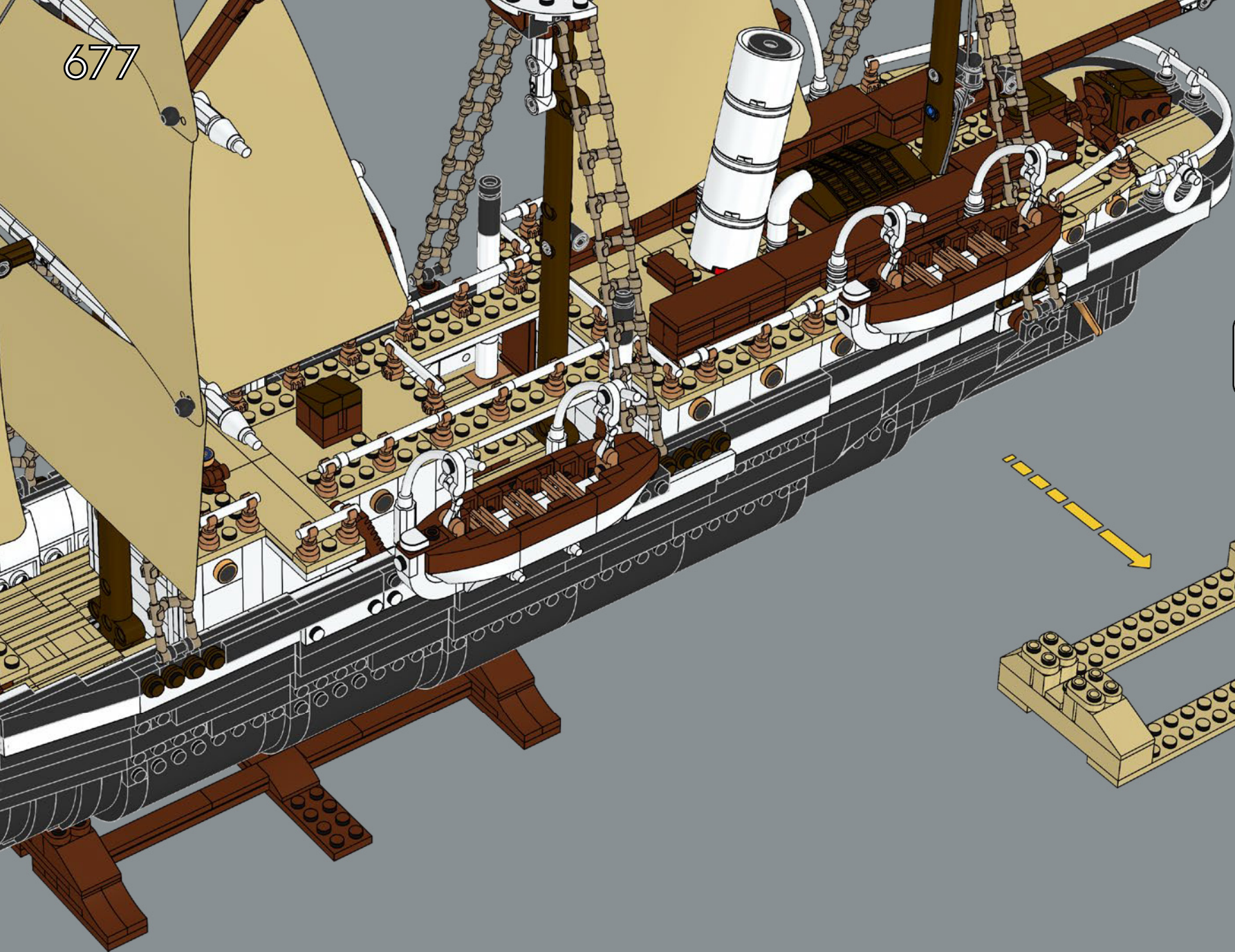

678

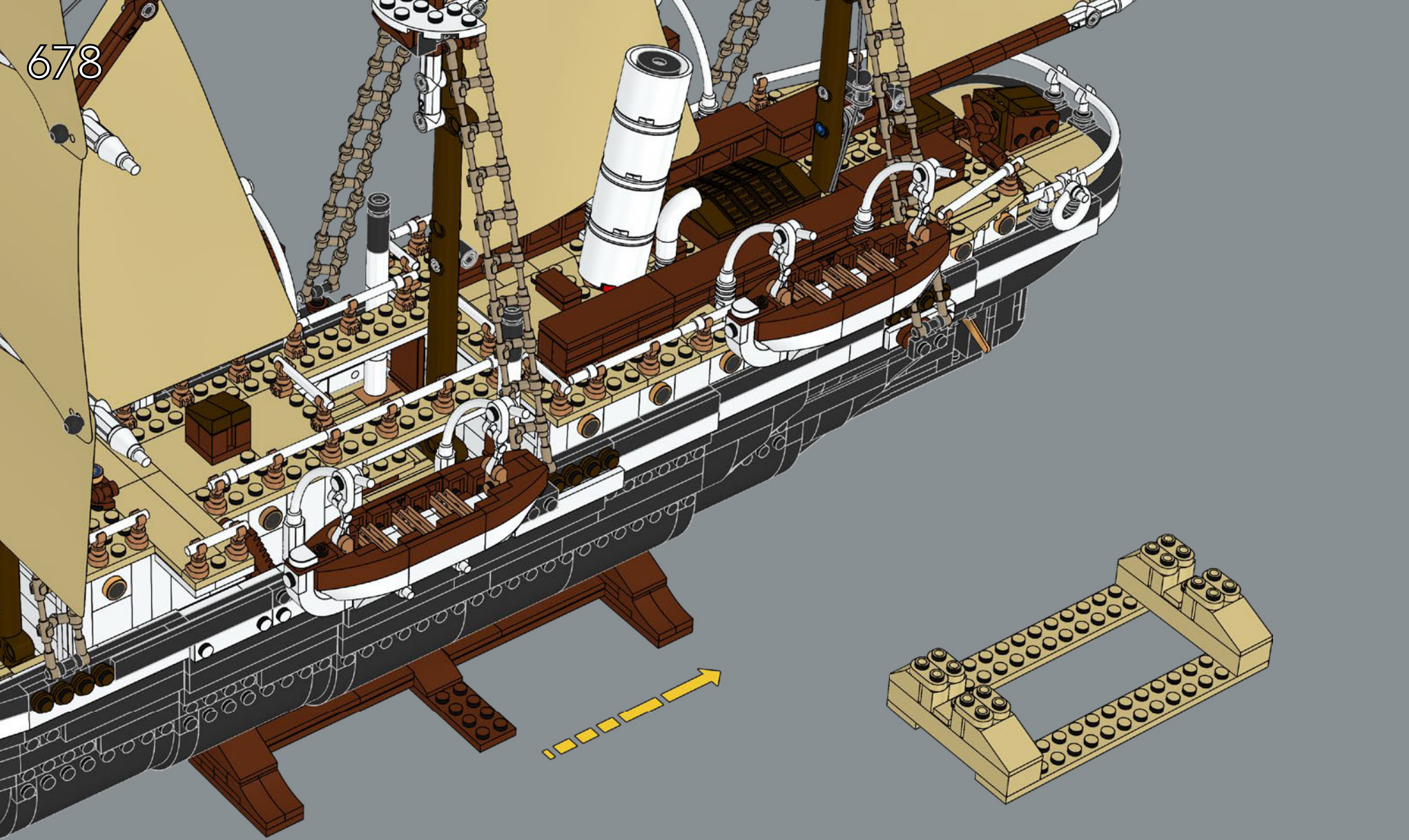

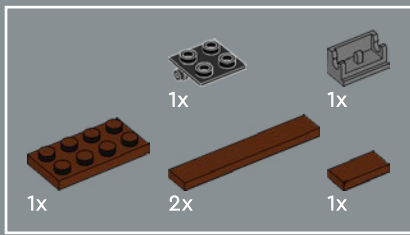

679

1

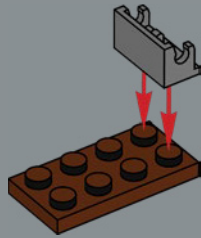

2

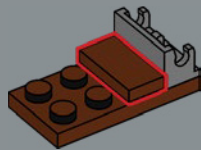

3

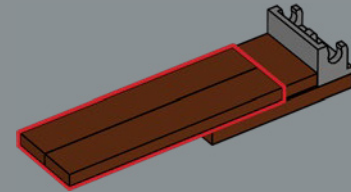

4

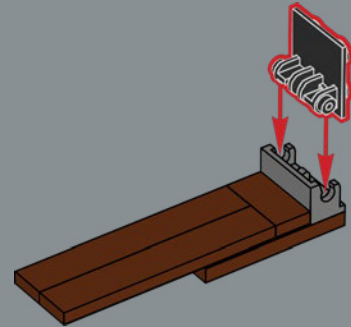

5

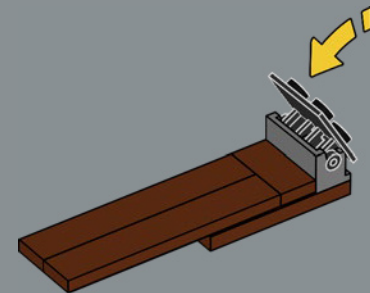

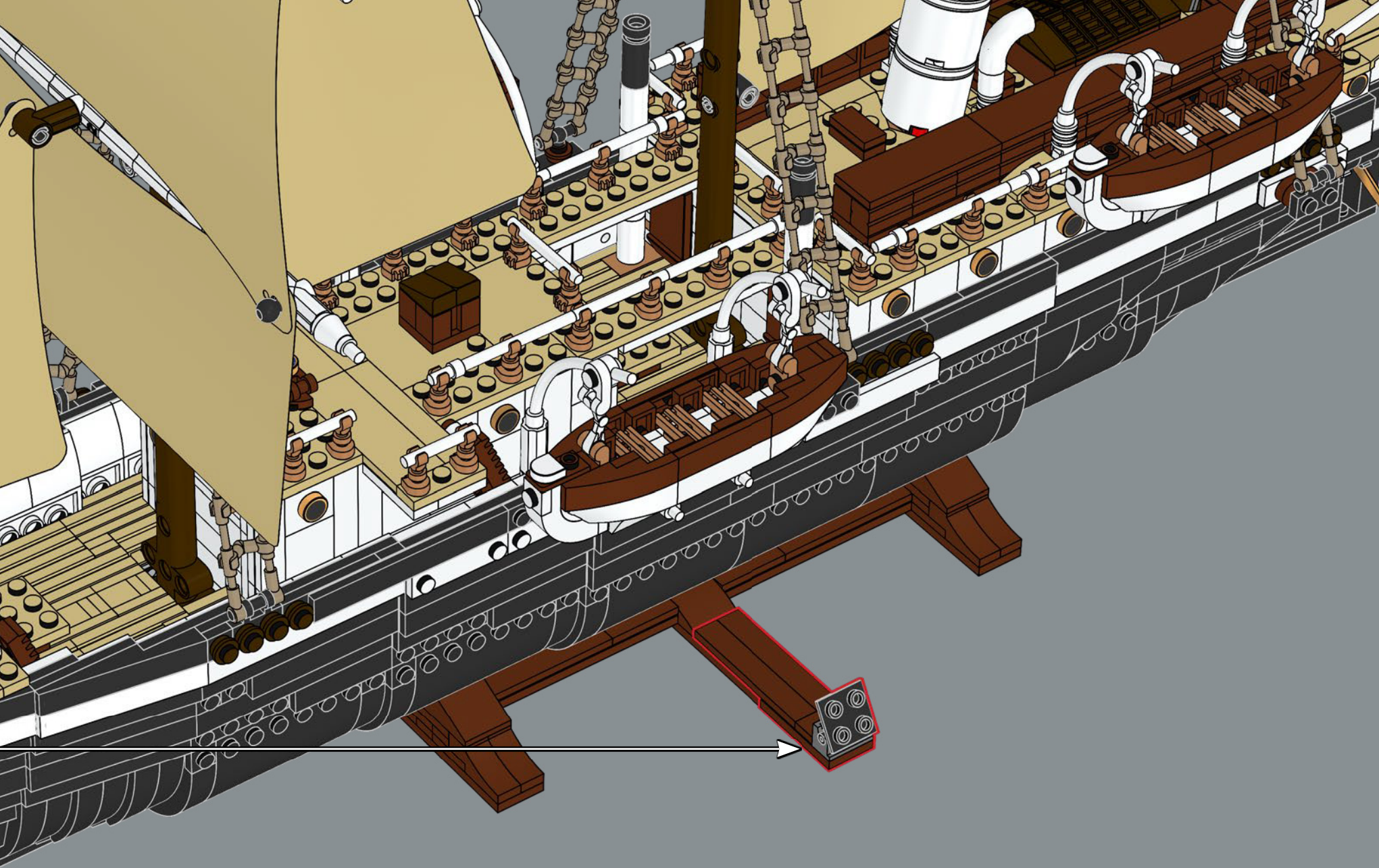

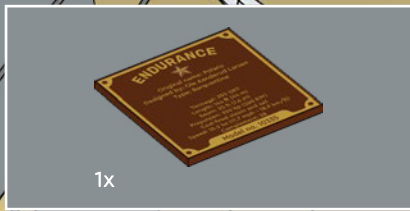

680

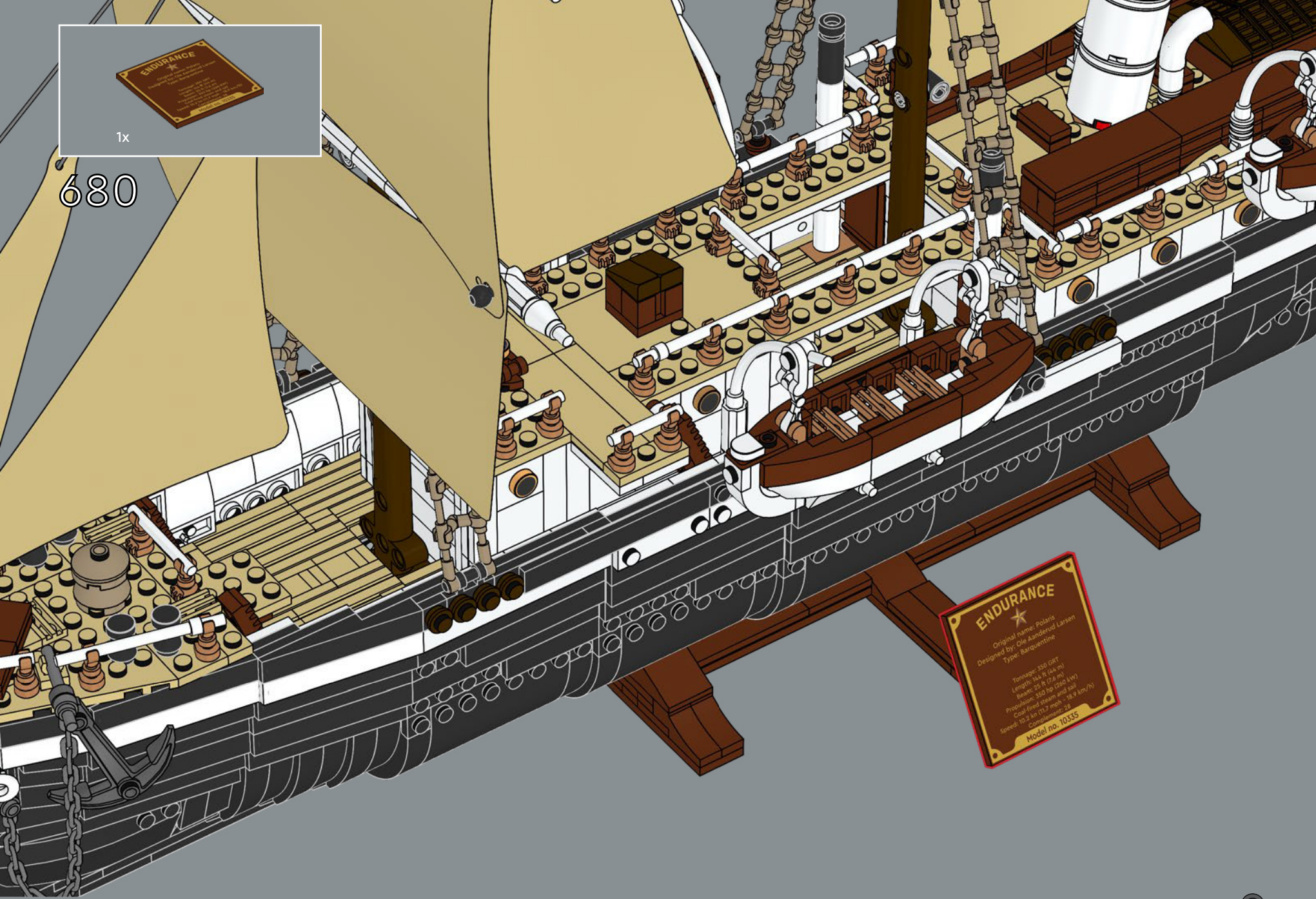

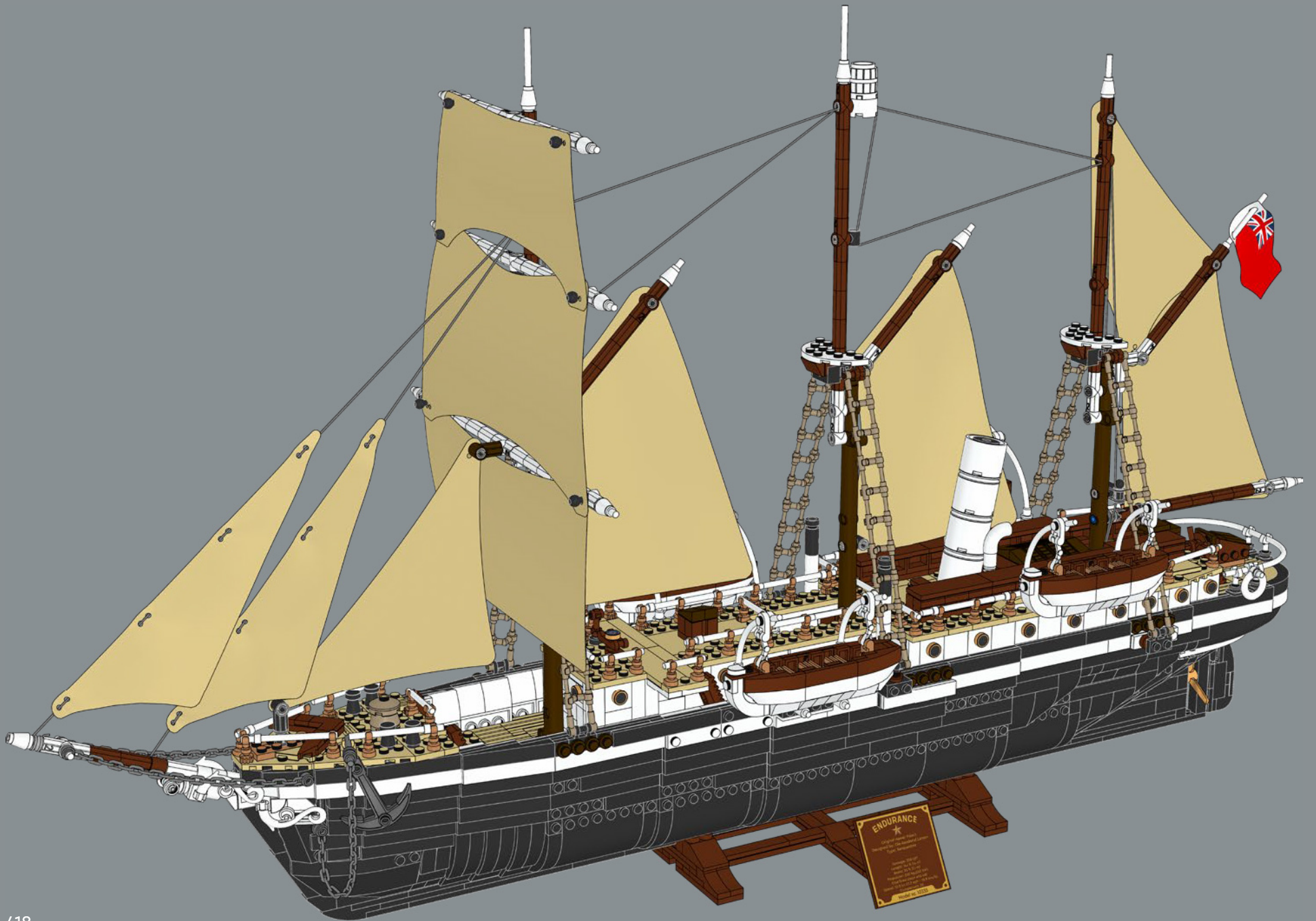

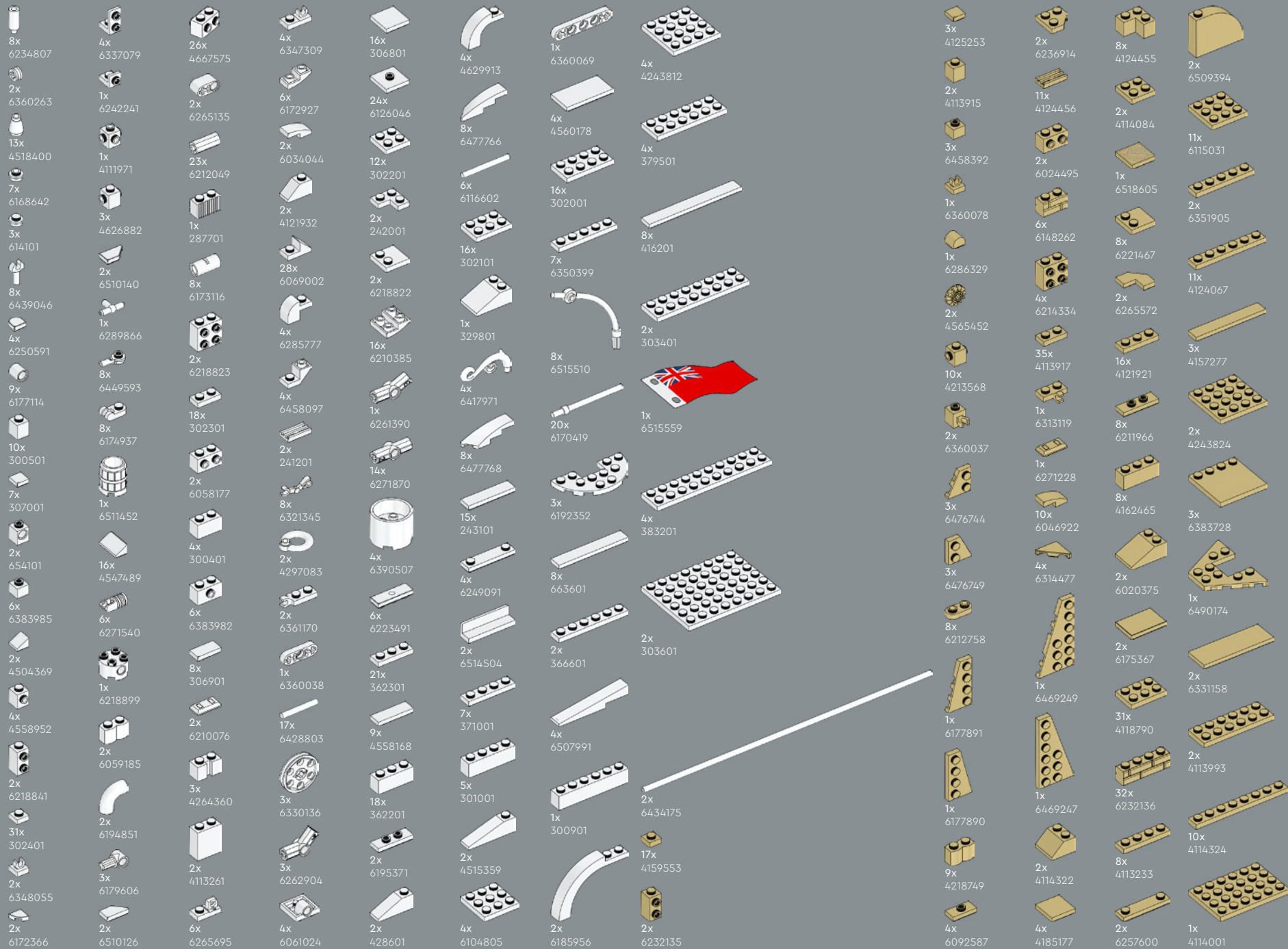

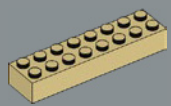

2x
6037398

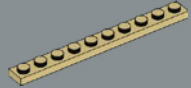

3x
4143409

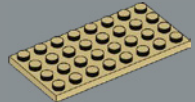

3x
4509897

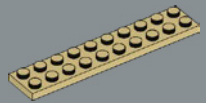

9x
4249019

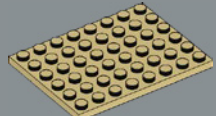

2x
6070501

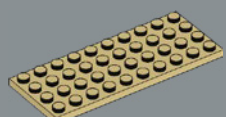

3x
6037834

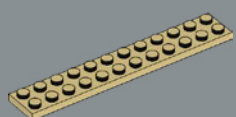

2x
6093864

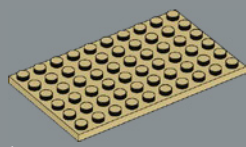

1x
4624185

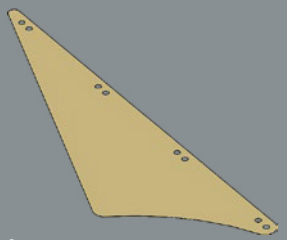

2x
6509959

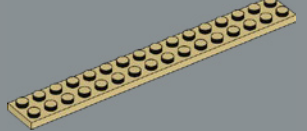

2x
6030980

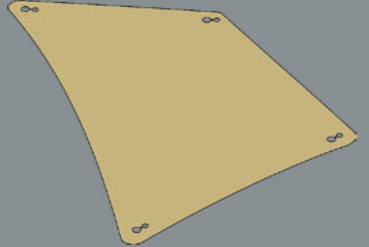

1x
6509952

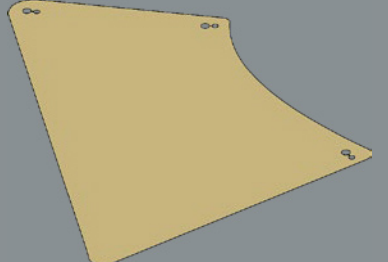

2x
6509954

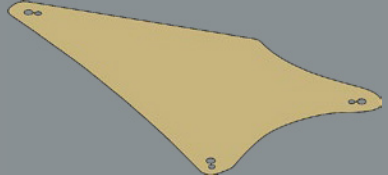

1x
6509953

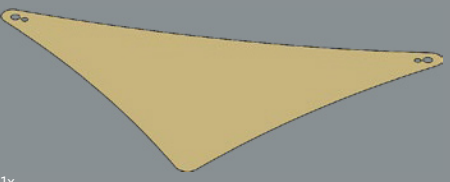

1x
6509958

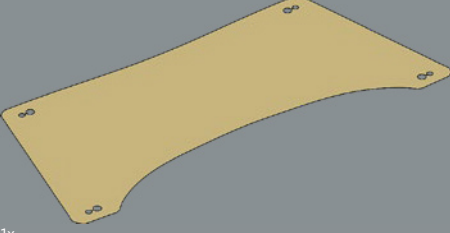

1x
6509955

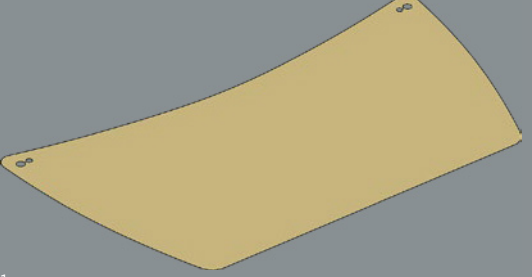

1x
6509957

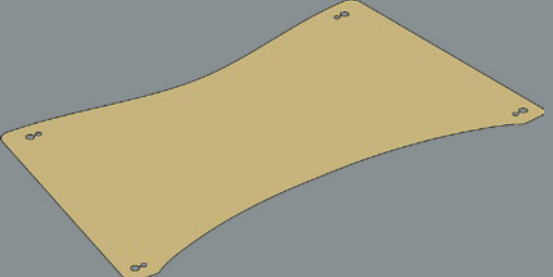

1x
6509956

- 2x 614121
- 1x 6271820
- 64x 4142865

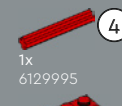

1x
6129995



8x
300121



5x
4206482



4x
6271167



4x
6130007



1x
300124



4x
6186675



6x
6168646



4x
6284070



4x
4529236



1x
6332148



1x
6284699



8x
407026



4x
307026



22x
302426

2x
4504382

1x
654126

4



5x
6388352



2x
6335388



1x
4566308



6x
6234695



3x
4214559



2x
6509664



19x
6344752



1x
6141554



2x
6104209



1x
6265699



1x
6141556



2x
4180536



2x
4180508

6x
6513918

10x
4548180



2x
6051508



4x
6477759



9x
403226



18x
6279875



1x
4109810



1x
6271535



2x
6195325



1x
6143850



4x
6507846



6x
6282140



1x
4283260



28x
4253815



2x
6173119

7x
6047276

2x
6475339

18x
302326



2x
393726



1x
366526



8x
300426



9x
6092585



5x
306926



7x
6184784



6x
6069000



2x
4121966



4x
4140588



3x
4283047



3x
4283046



1x
6266224



1x
6266224

1x
6396457

8x
242026



6x
303926



10x
302226



2x
6053077



2x
6390748



2x
4567436



3x
4124096



1x
6089119



1x
6276951



14x
362326



8x
428626



7x
362226



5x
4526931



1x
4251161

3x
6517676

2x
6390749





2x
4271874



1x
6511449



2x
6469351



3x
4211214



6x
6055145

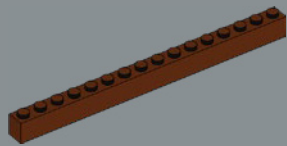

2x
6258989

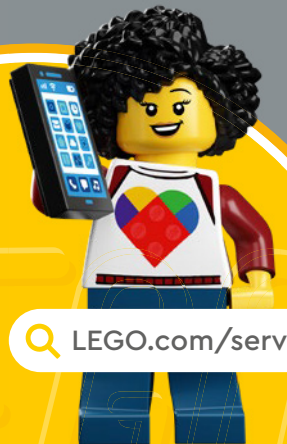

[LEGO.com/service](https://www.LEGO.com/service)

1x
6271165

2x
6275844

4x
6225242

6x
4211476

2x
4211389

1x
6329584

1x
6253856

2x
6248890

1x
6227897

1x
4211807

3x
4278273

3x
4211526

1x
6092956

1x
4512360

3x
6066097

4x
6123809

2x
6383177

6x
4211398

1x
4211470

1x
6004990

2x
6360043

10x
4211387

4x
4211397

9x
4211815

1x
4211536

4x
4211429

1x
6381253

6x
6093058

1x
4211773

8x
4211394

8x
4211425

8x
4251149

2x
6178172

2x
4211522

3

4x
4211090

6x
6231765

2x
6439040

4x
6395635

3x
6362259

7x
6344022

2x
6388133

1x
6225494

1x
4211042

1x
6115080

1x
6514456

2x
6230233

1x
4211066

3x
6092572

2x
6310596

6x
4210635

11

2x
6405646

6x
6015356

2x
4211133

3x
6365692

1x
4239891

1x
6378143

12x
4211043

4x
4211105

8x
4211001

1x
4211103

13x
6039176

2x
6431485

1x
4508553

11x
4211002

55

2x
4499858

1x
4211099

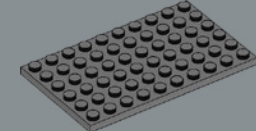

2x
4211114



3x
6258887

1x
6510133

32x
6511448

1x
6287847

2x
6186672

1x
6328909

1x
6034543

1x
6490722

32x
6315780

3x
6322813

1x
6332586

8

8x
6509391

8x
6509392

1x
4566688

2x
6058221

2x
6347604

1x
6515036

1x
6331950

1x
6331950

1x
6331950

1x
6331950

1x
6331950

1x
6331950

1x
6331950

1x
6331950

3x
6523484

56x
6509393

3x
6057986

3x
6314190

3x
6457557

4x
6215606

2x
6474266

12x
6324205

2x
6360035

10x
4651231

2x
6192920

22x
6218360

2x
6431328

4x
6411587

2x
4656783

12x
6452541

8x
6167699

1x
6336665

4x
6055309

1x
6257605

2x
6489195

31x
6343854

2x
6313600

4x
6208446

1x
6474270

1x
6474270

1x
6474270

1x
6474270

1x
6474270

1x
6474270

1x
6474270

1x
6474270

1x
6474270

1x
6474270

1x
6452863



YOU COULD WIN



YOU COULD WIN

Your feedback will help shape the future development of this product series.

Visit:

DU KÖNNTEST GEWINNEN

Dein Feedback trägt zur Weiterentwicklung dieser Produktreihe bei.

Geh auf:

VOUS POURRIEZ GAGNER

Vos commentaires nous aideront à concevoir les futurs produits de cette gamme.

Visitez :

POTRESTI VINCERE TU

La tua opinione ci aiuterà a migliorare la creazione futura di questa linea di prodotti.

Visita:

PUEDES GANAR

Tu opinión contribuirá al futuro de esta serie de productos.

Visita:

轻松获奖

您的反馈将有助于我们在今后改进本产品系列。

请访问:

[LEGO.com/productfeedback](https://www.lego.com/productfeedback)

You also have the chance to win a LEGO® set.

Terms and conditions apply.*

Außerdem hast du die Chance, ein LEGO® Set zu gewinnen.

Es gelten die Teilnahmebedingungen.*

Vous pourriez également gagner un ensemble LEGO®.

Des conditions s'appliquent.*

Hai anche la possibilità di vincere un set LEGO®.

Termini e condizioni sono applicabili.*

También tienes la oportunidad de ganar un set LEGO®.

Aplican términos y condiciones.*

您还有机会赢取乐高®套装。

条款和条件适用。*

*[LEGO.com/productfeedback-terms](https://www.lego.com/productfeedback-terms)



LEGO and the LEGO logo are trademarks of the LEGO Group.
©2024 The LEGO Group.